









2027 Tiffin RED Integration Schematics

www.spydercontrols.com



Table Of Contents

Component Locations	1	Power Systems	23
DC Distribution	2	HCR-11	24
Misc. Modules	3	Merge System	25
Misc. Modules Cont.	4	Merge Logic	26
LCD Screens	5	Generator	27
Pinouts	6	DCD Panel	28
M1 Front Panel Pinout	7	DCD Panel Cont.	29
G12 Pinout - Outputs	8	Network	30
G12 Pinout - Inputs	9	Network	31
Mechanical Systems	10	Network Cont.	32
Slides	11	Always On	33
Slide Adapter	12	Additional Information	34
MoRyde TV Lift	13	Connectors	35
Whisper Ride TV Lift	14	Connectors & Tools	36
Motors & Pumps	15		
Tanks	16		
HVAC	17		
Aircons	18		
Thermistors	19		
Floorheat	20		
Vent Fan (Maxxfan)	21		
Vent Fan (Non-Maxxfan)	22		

Connection Legend	
Line Color	Line Meaning
	(GND) Constant Ground
	(12V+) Constant 12V+
	Switched 12V+
	Signal (Arrow Points to Signal Direction)
	(GND) Ground Input (Arrow Points to Input Device)
	(12V+) 12V+ Input (Arrow Points to Input Device)
	Reverse Polarity
	Network/Communication
	120 VAC LINE

Component Locations

Component Locations - RED

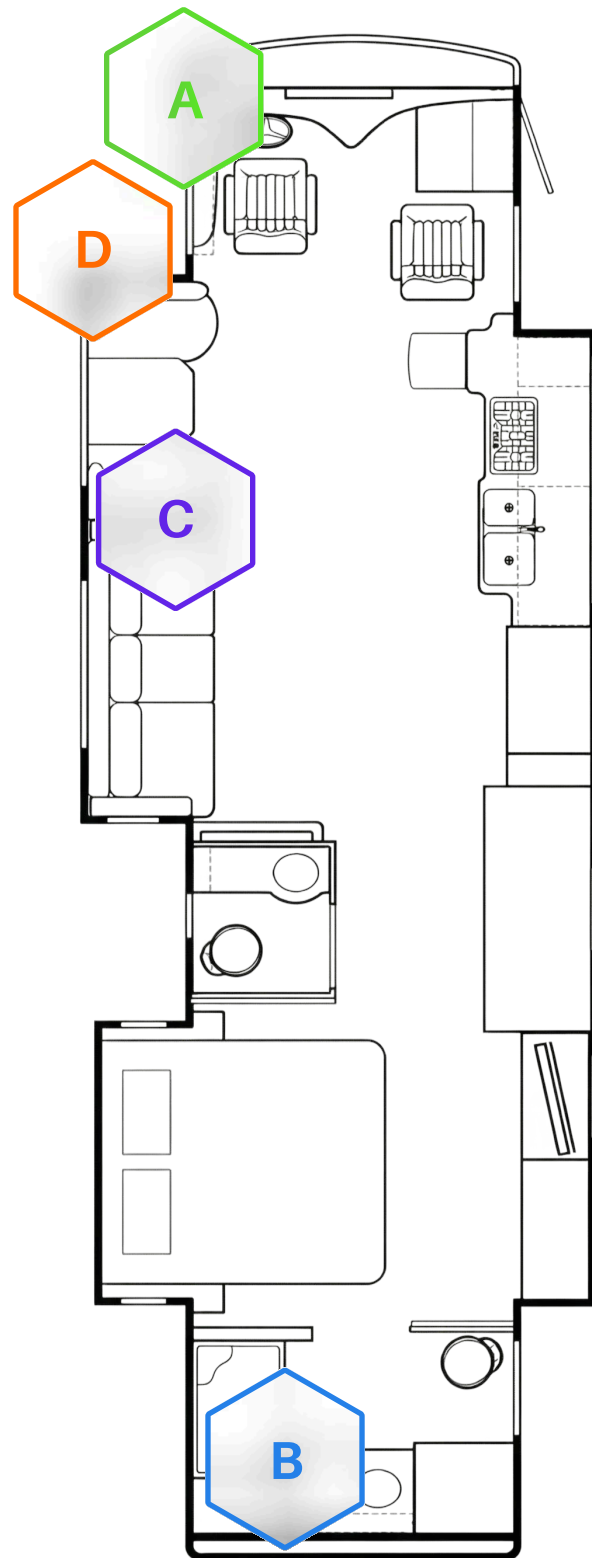

Front M1 Panel

Spyder PN
BENCZM2DS-1

Tiffin PN
5126983

Dimensions
10" X 7.8"

D/S Ext Compartment

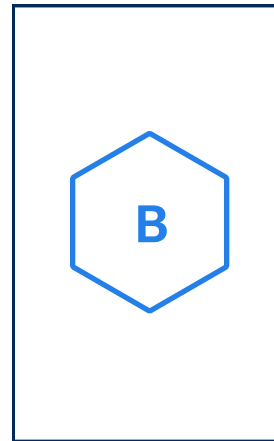
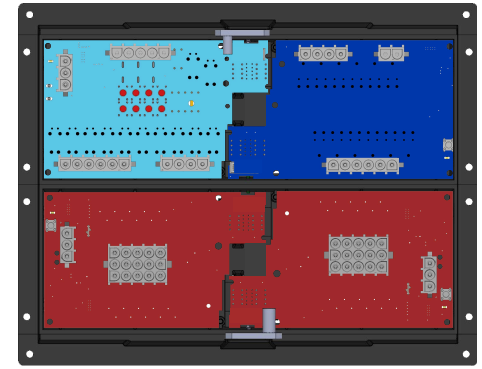

G12 Module

Spyder PN
BMODZU2VU

Tiffin PN
51XXXXX

Dimensions
9" X 5.9"

Rear Closet

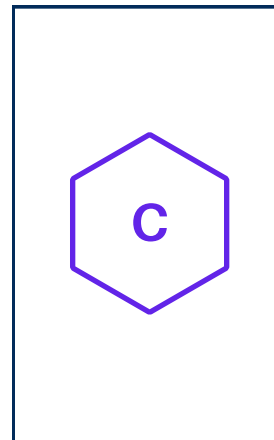
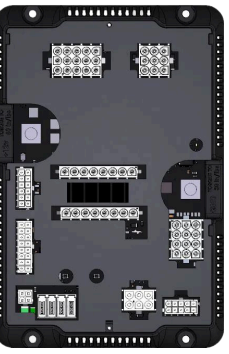

DCD Panel

Spyder PN
BENCZ38DS-4

Tiffin PN
51XXXXX

Dimensions
9.1" X 10"

Inverter Bay

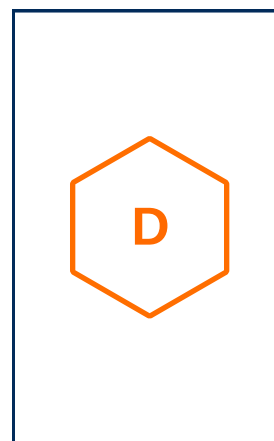
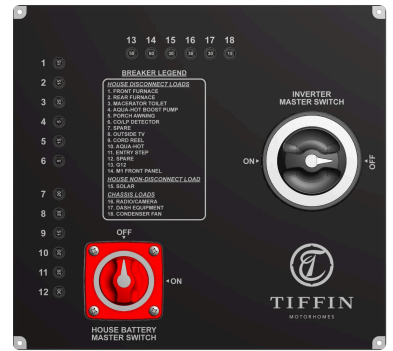

Terminator HCR-11 Drop Tap

Spyder PN
BMODZGAN6-1

Tiffin PN
5131310

Dimensions
2.5" X 2"

Front D/S Compartment

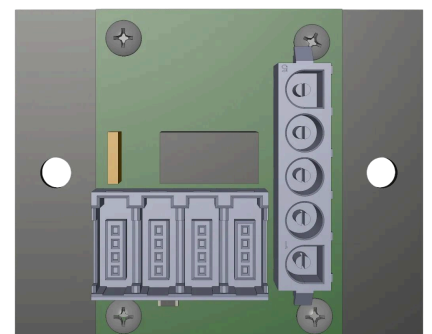

Component Locations - RED

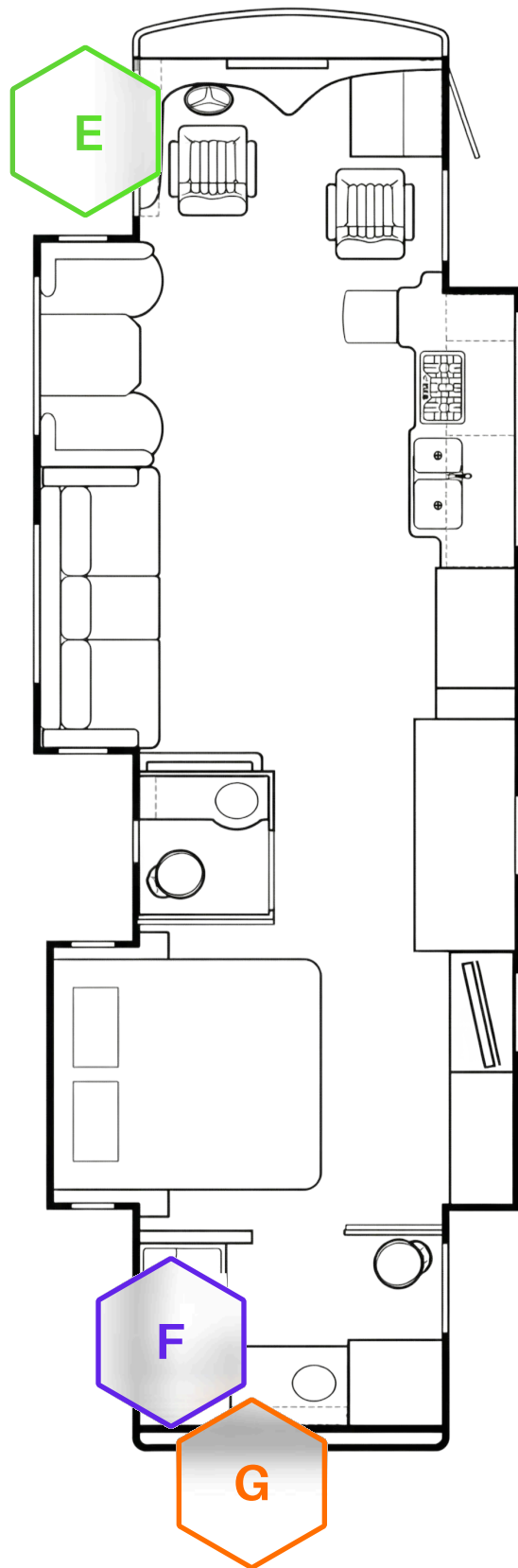

Slide Adapter (If Equipped With Lippert Slides) Front D/S Compartment

Spyder PN
BMODZGAN6-1

Tiffin PN
5131310

Dimensions
2.5" X 2"

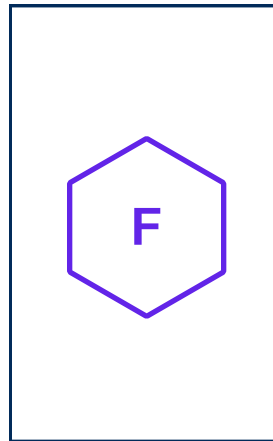
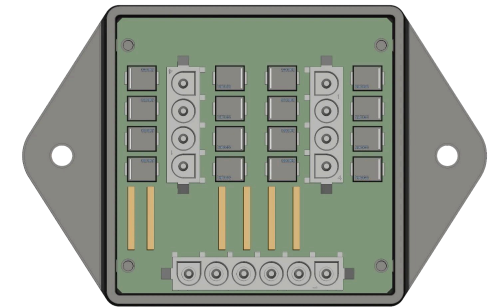

HCR-15 TV Lift Rear Closet

Spyder PN
BMODZQFCN-A

Tiffin PN
5134953

Dimensions
3" X 3"

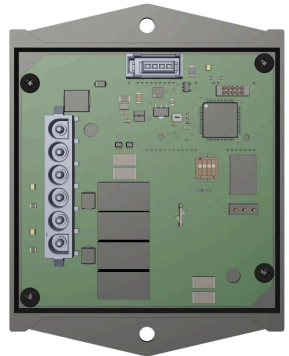

Bridge Module (If Equipped With Truma) Rear Closet

Spyder PN
BMODZTCT0

Tiffin PN
5127271

Dimensions
3" X 3"

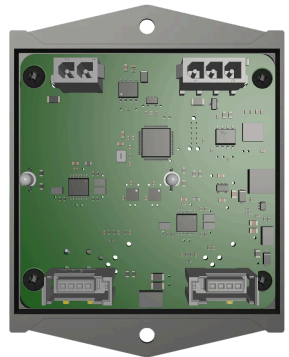

Component Locations - RED

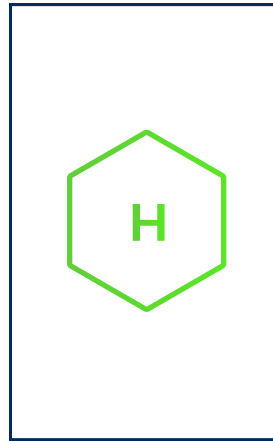
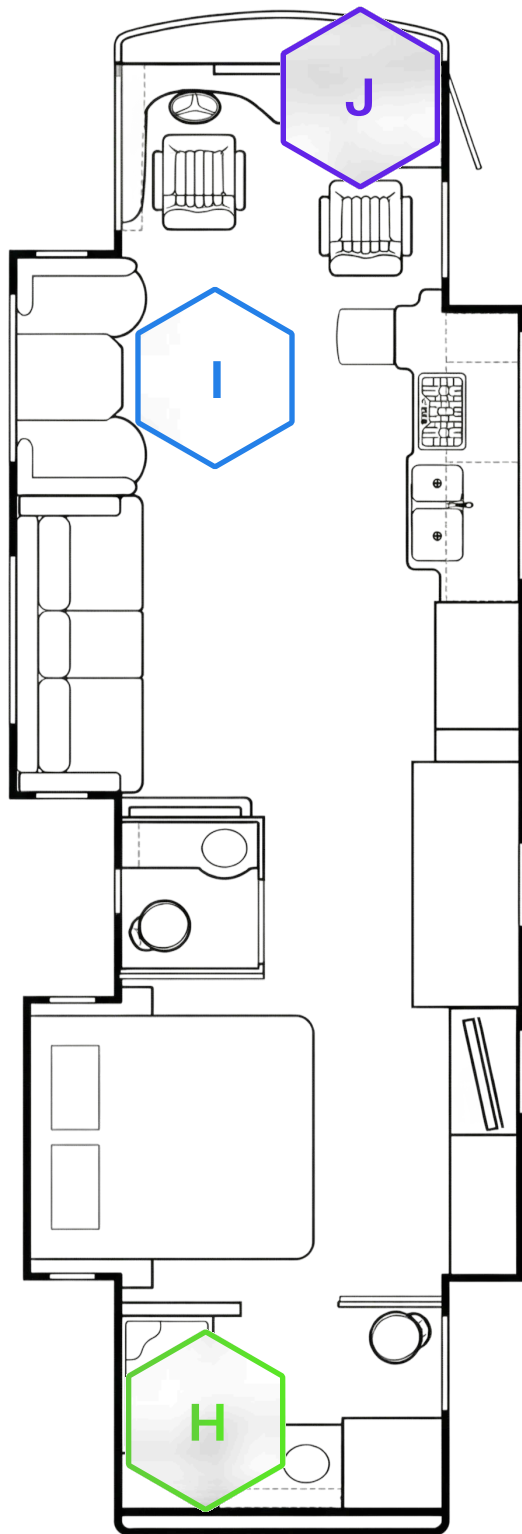

Network Tap Rear Closet

Spyder PN
BMODZMIM1-2SA

Tiffin PN
51XXXXX

Dimensions
6" X 4.8"

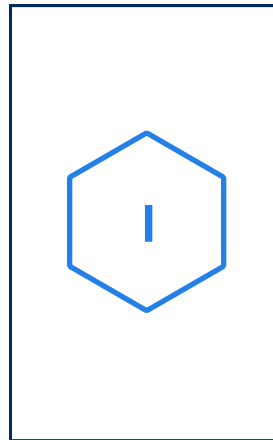
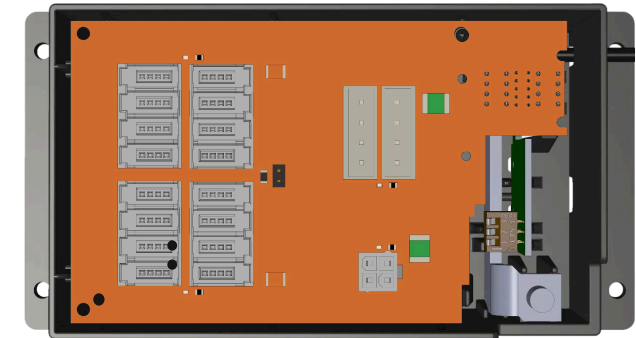

RF Hub Ceiling

Spyder PN
BMODZRFT0-W

Tiffin PN
5141264

Dimensions
5.1" Diameter

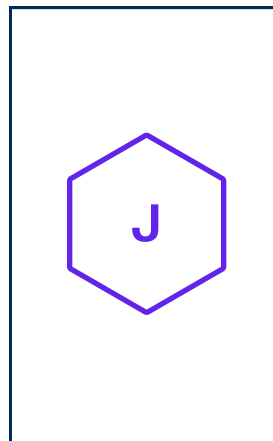

Mira Module (Not Manufactured By Spyder) Front O/H Cabinet

Tiffin PN
51XXXXX

Dimensions
4" X 2.5"



Component Locations - RED

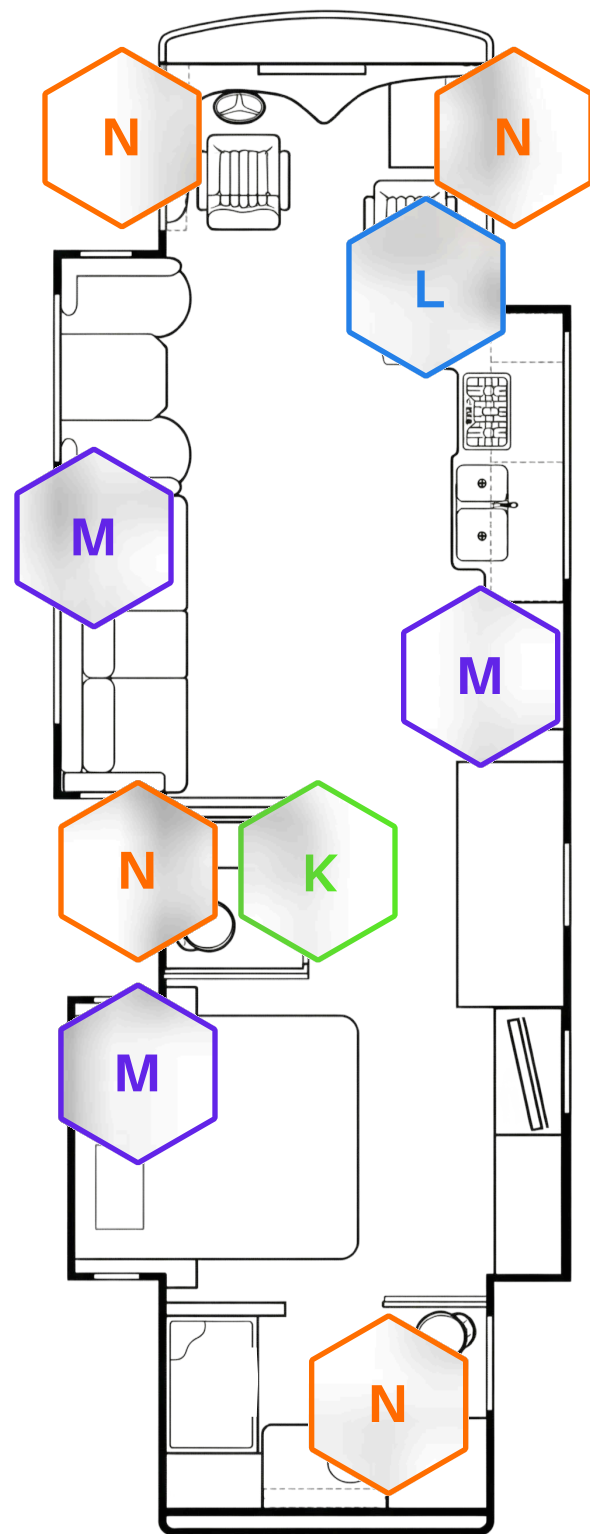

• Switch Location And Quantity Will Vary Based On Floorplan And Coach Model

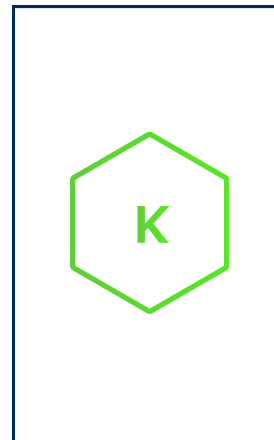

7" Pro LCD

Spyder PN

BSSPZZPEF

Dimensions

10.5" X 7.3"

Hall Wall

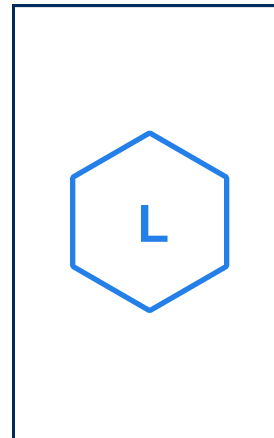

5" Entry LCD

Spyder PN

BSSPZZREK

Tiffin PN

51XXXXX

Dimensions

5.6" X 3.85"

Entry

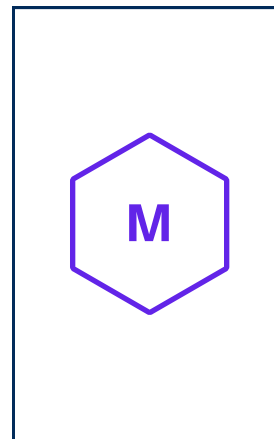

3.5" LCD

Spyder PN

BSSPZZTED

Tiffin PN

5127291

Dimensions

4.5" X 2.9"

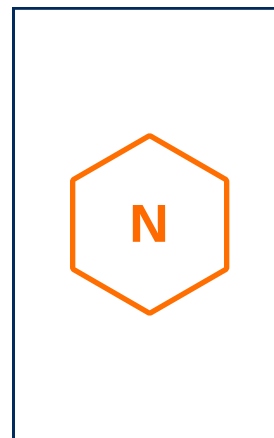

SSP-17 Switch Panel (2-Pos, 4-Pos, 8-Pos)

Spyder PN

BSSPZZEEE (8-Pos), BSSPZZDEE (4Pos),
BSSPZZCDA-3 (2Pos)

Tiffin PN

On Back Of Switch Panel



M1 & G12 Pinouts

Front M1 Panel Pinout - RED

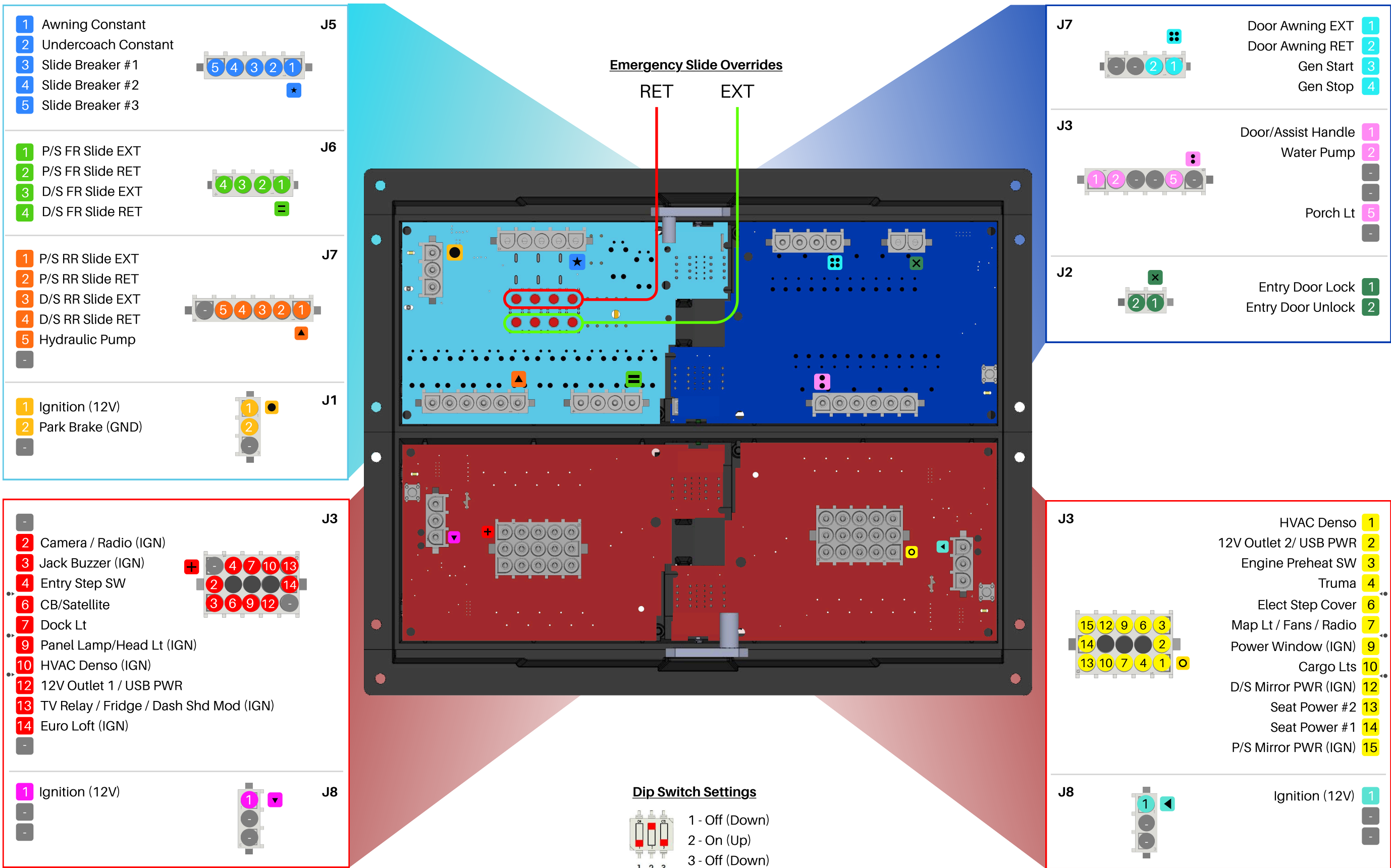

G12 Module Pinout - RED - Outputs

J4

1	P/S Slide Lt
2	D/S Slide Lt
3	Living Room Lt
4	TV Accent Lt
5	Entry Lt
6	Task Lt
7	Hall Lt
8	Bedroom Ceiling Lt
9	Rear Bath Ceiling Lt
10	Mid Bath Ceiling Lt
-	-
-	-
13	Sconce Lt
14	FR Accent Lt
15	Galley Lt

J8

1	Galley Fan Lid Up
2	Galley Fan Lid Down
3	Mid Bath Fan Lid Up
4	Mid Bath Fan Lid Down
5	Rear Bath Fan Lid Up
6	Rear Bath Fan Lid Down
7	Front Furnace Trigger
8	Rear Furnace Trigger

J3

-	-
-	-
-	-
9	6
8	5
7	4

Sofa Reading Lt	4
Ceiling Fan Hi	5
Ceiling Fan Lo	6
Galley Fan	7
Mid Bath Fan	8
Rear Bath Fan	9

J10

10	11	12
7	8	9
4	5	6
1	2	3

FR A/C Compressor	1
FR A/C Fan Hi	2
FR A/C Fan Lo	3
FR A/C Heat Pump	4
Mid A/C Compressor	5
Mid A/C Fan Hi	6
Mid A/C Fan Lo	7
Mid A/C Heat Pump	8
RR A/C Compressor	9
RR A/C Fan Hi	10
RR A/C Fan Lo	11
RR A/C Heat Pump	12



G12 Module Pinout - RED - Inputs

J12

1	FR Floor Thermistor
2	RR Floor Thermistor
3	FR A/C Thermistor
4	Mid A/C Thermistor
5	RR A/C Thermistor
6	Bay Thermistor
7	FR Floor Thermistor GND
8	RR Floor Thermistor GND
9	FR A/C Thermistor GND
10	Mid A/C Thermistor GND
11	RR A/C Thermistor GND
12	Bay Thermistor GND

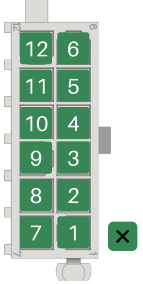

J13

1	LPG Signal (0-90 Ohms)
4	LPG GND
6	Gen Run Status (+12V)

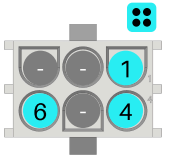

J11

1	Fresh Tank Sensor Input
2	Grey Tank Sensor Input
3	Black Tank Sensor Input
9	Tank Sensor GND
10	Tank Sensor GND
11	Tank Sensor GND



J5

1	Park Brake (GND)
2	Water Pump Sw (GND)
3	Entry Door Pin Sw (GND)
4	Merge Status (GND)
6	IGN Input (+12V)
8	Shore Power Sense (+12V)
9	Water Heater Status (+12V)

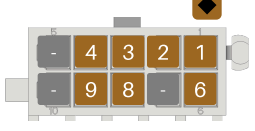
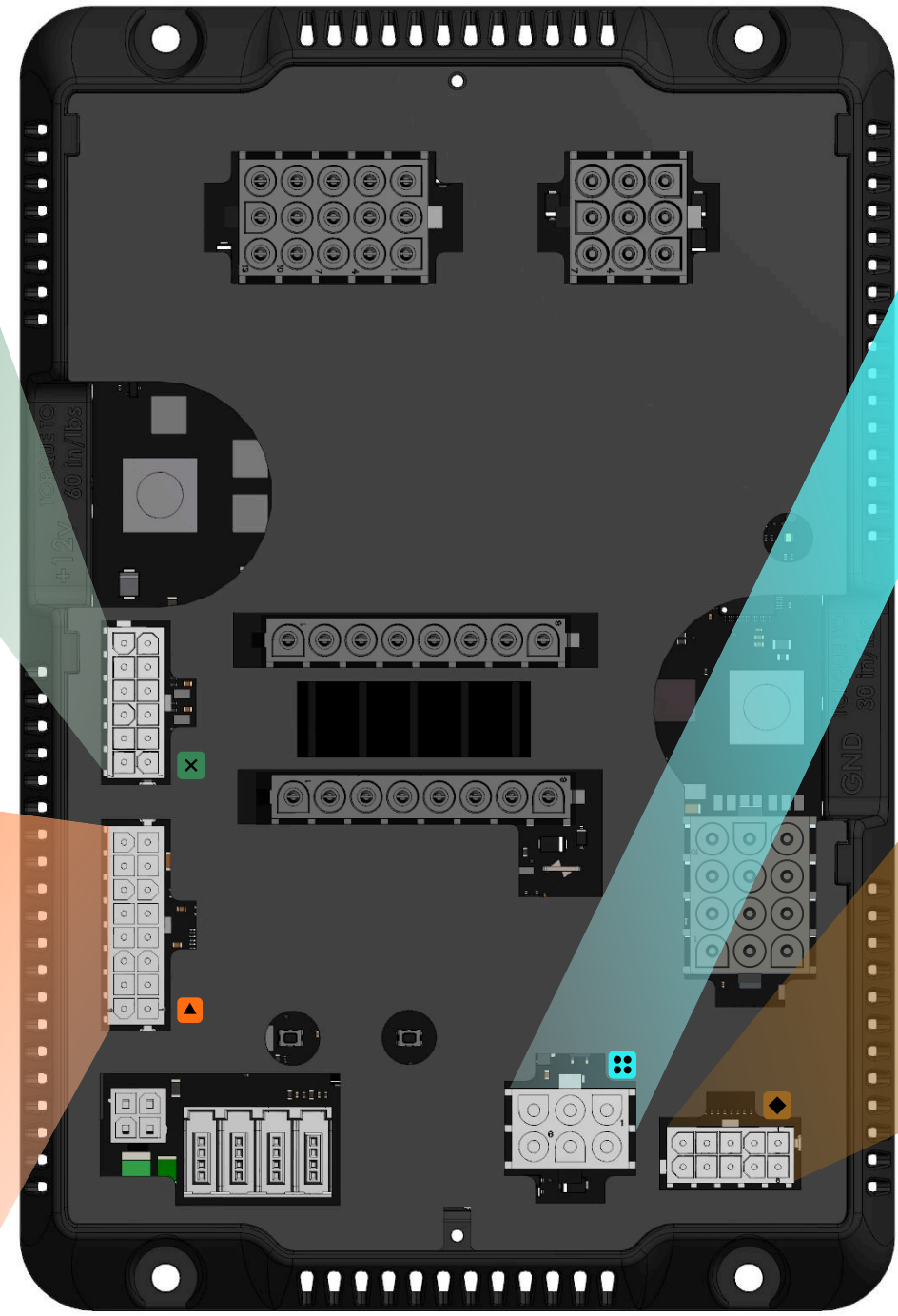
Mechanical Systems

Slides

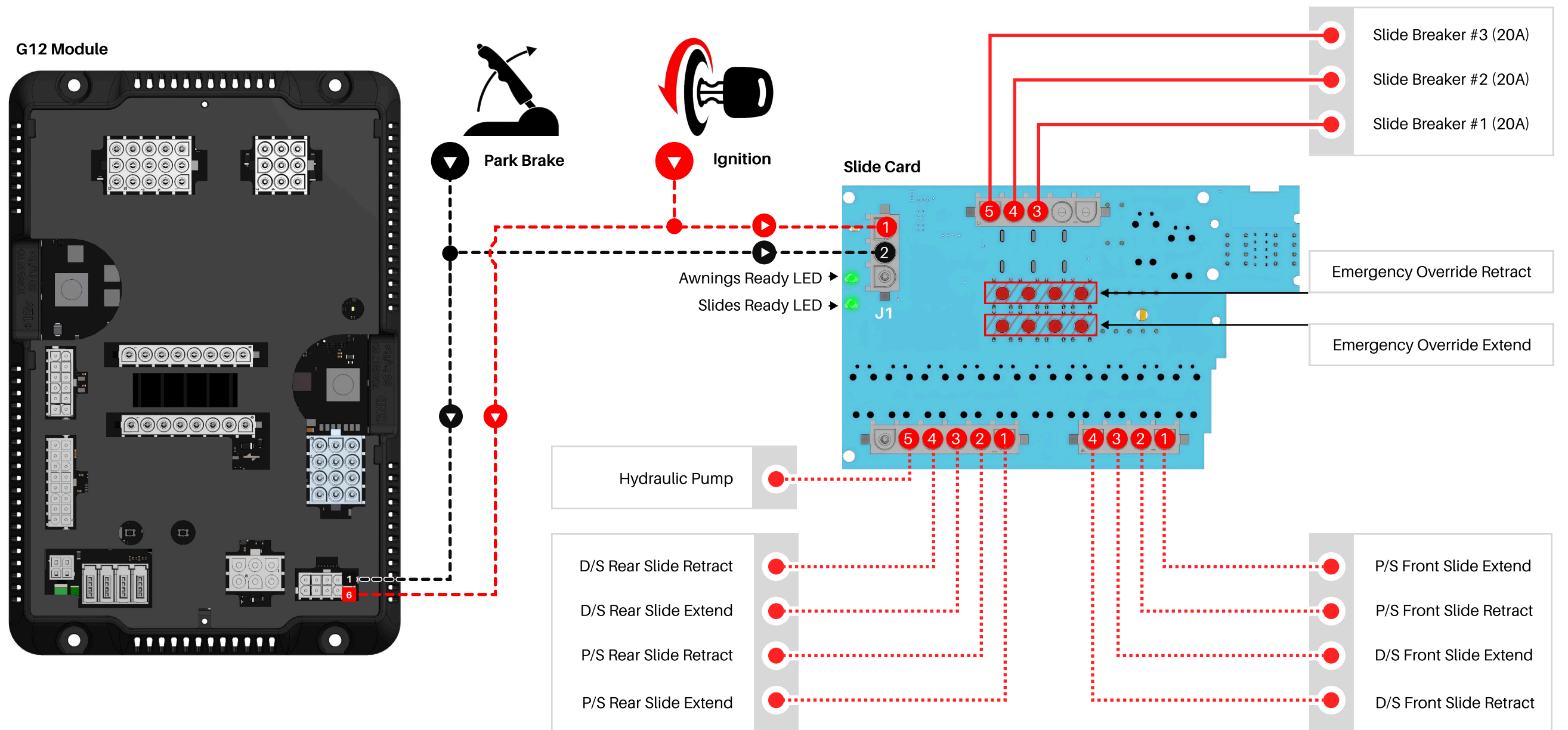

Slide Safety And Overrides

To ensure safe and predictable slide operation, several safety measures are built into the Spyder system. The core of these protections is the **park brake and ignition interlock**.

The Slide Card has dedicated park brake and ignition inputs. These act as a **physical lockout**: if 12V+ and GND are not present at the Slide Card (J1) before operating the slides, the **slides will not extend**. The G12 also receives secondary park brake and ignition inputs. These inputs send a message over the Spyder Network telling all devices that park brake and ignition are active.

Because the safety inputs are split between the G12 and the Slide Card, certain wiring issues can cause the LCD to show “**Slides Ready**” even though the slides will not operate. If you encounter slide issues, check the Slides Ready LED on the Slide Card in the front M1 panel.



- In the event of a system failure, **Emergency Overrides** are available on the **front M1 panel**. To use them, **press and hold one of the red buttons** with a non-metallic object in the direction you want the slide to move. The slide will run while the button is held and stop when you release it. **Emergency overrides** will only function if park brake and ignition signals are being received by the Slide Card.

Slides

G12 Module

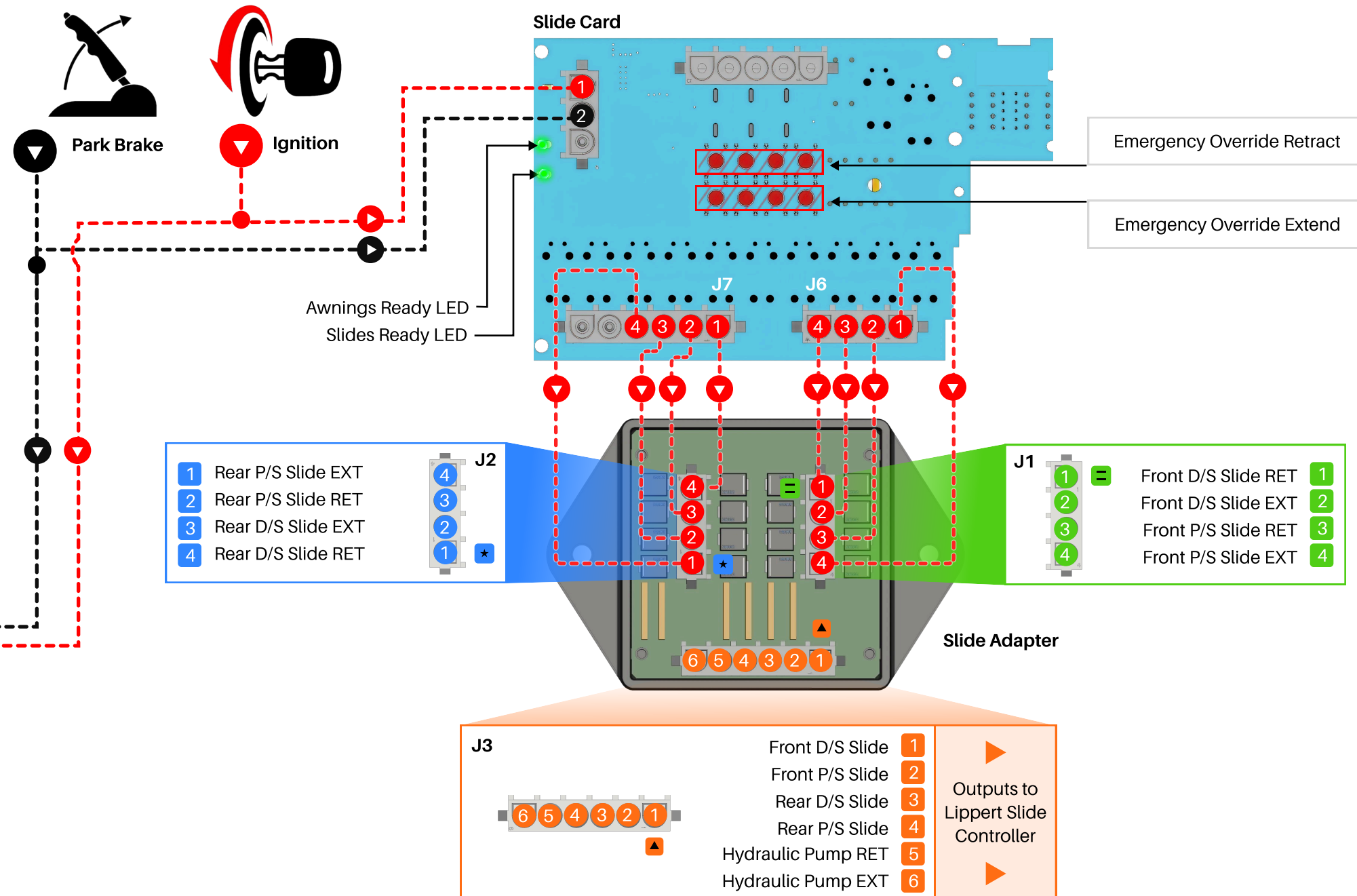
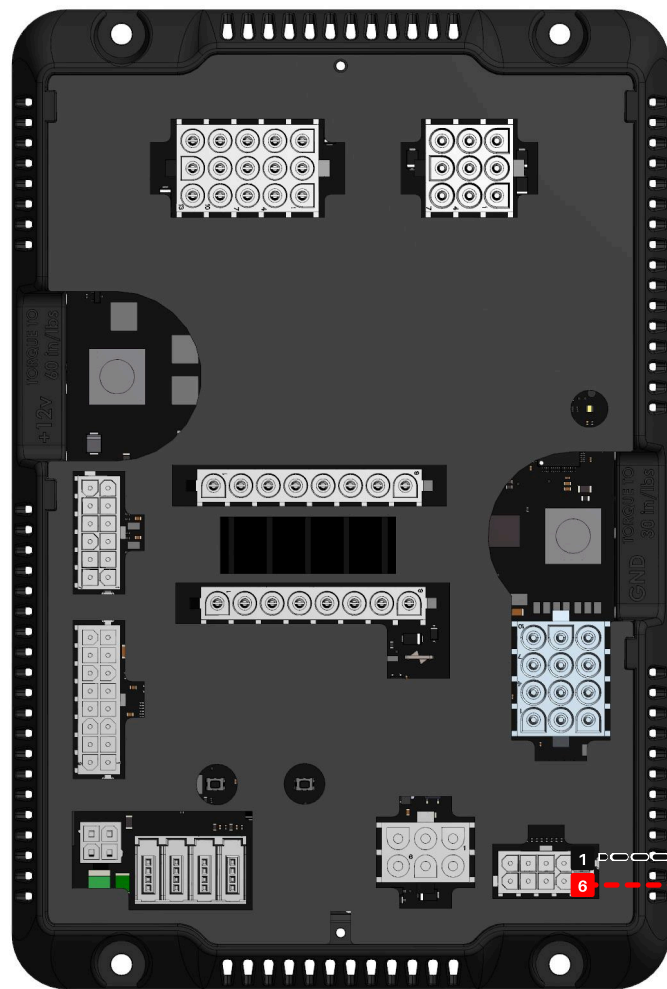

Slide Safety And Overrides

To ensure safe and predictable slide operation, several safety measures are built into the Spyder system. The core of these protections is the **park brake and ignition interlock**.

The Slide Card has dedicated park brake and ignition inputs. These act as a **physical lockout**: if 12V+ and GND are not present at the Slide Card (J1) before operating the slides, the **slides will not extend**. The G12 also receives secondary park brake and ignition inputs. These inputs send a message over the Spyder Network telling all devices that park brake and ignition are active.

Because the safety inputs are split between the G12 and the Slide Card, certain wiring issues can cause the LCD to show **"Slides Ready"** even though the slides will not operate. If you encounter slide issues, check the Slides Ready LED on the Slide Card in the front M1 panel.



- In the event of a system failure, **Emergency Overrides** are available on the **front M1 panel**. To use them, **press and hold one of the red buttons** with a non-metallic object in the direction you want the slide to move. The slide will run while the button is held and stop when you release it. **Emergency overrides** will only function if park brake and ignition signals are being received by the Slide Card.

MoRyde TV Lift

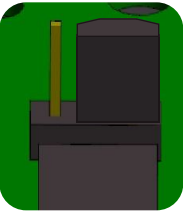
TV Lift	Location Settings
	The location setting for the HCR-15 can be changed via connector J5.

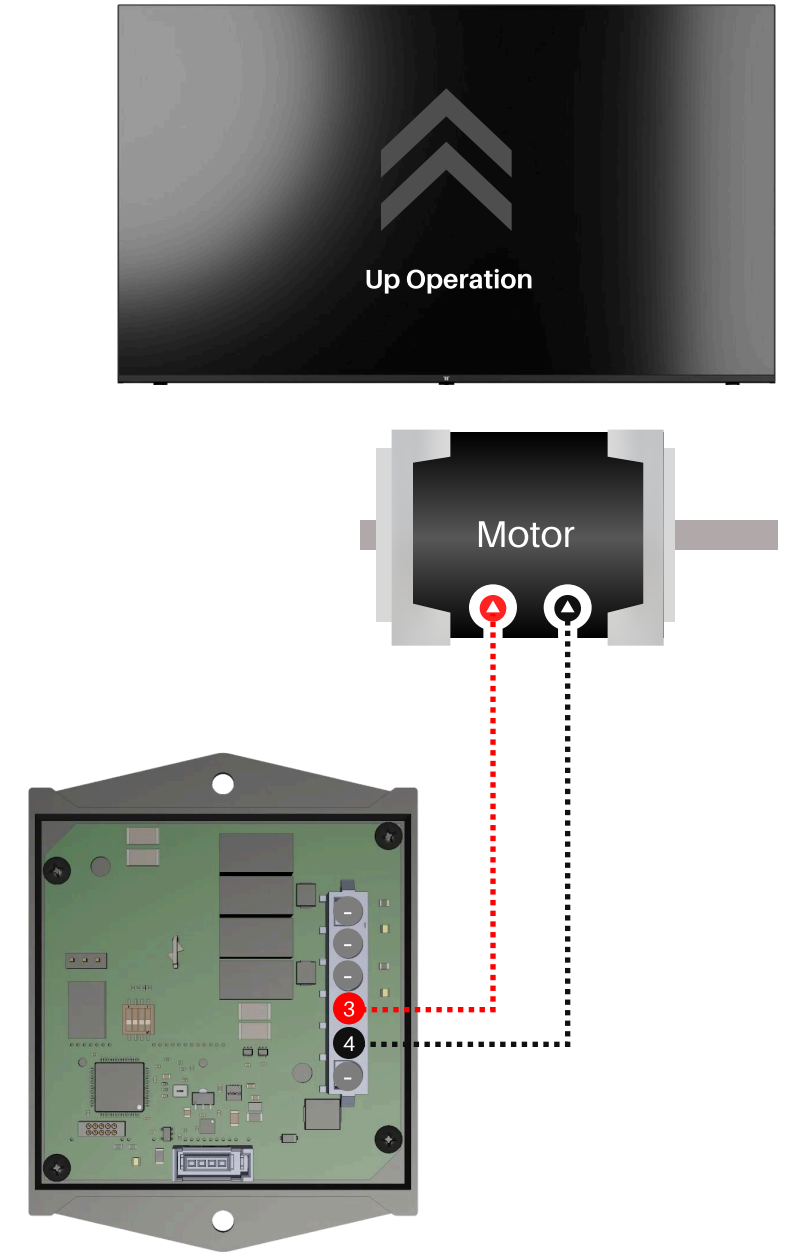
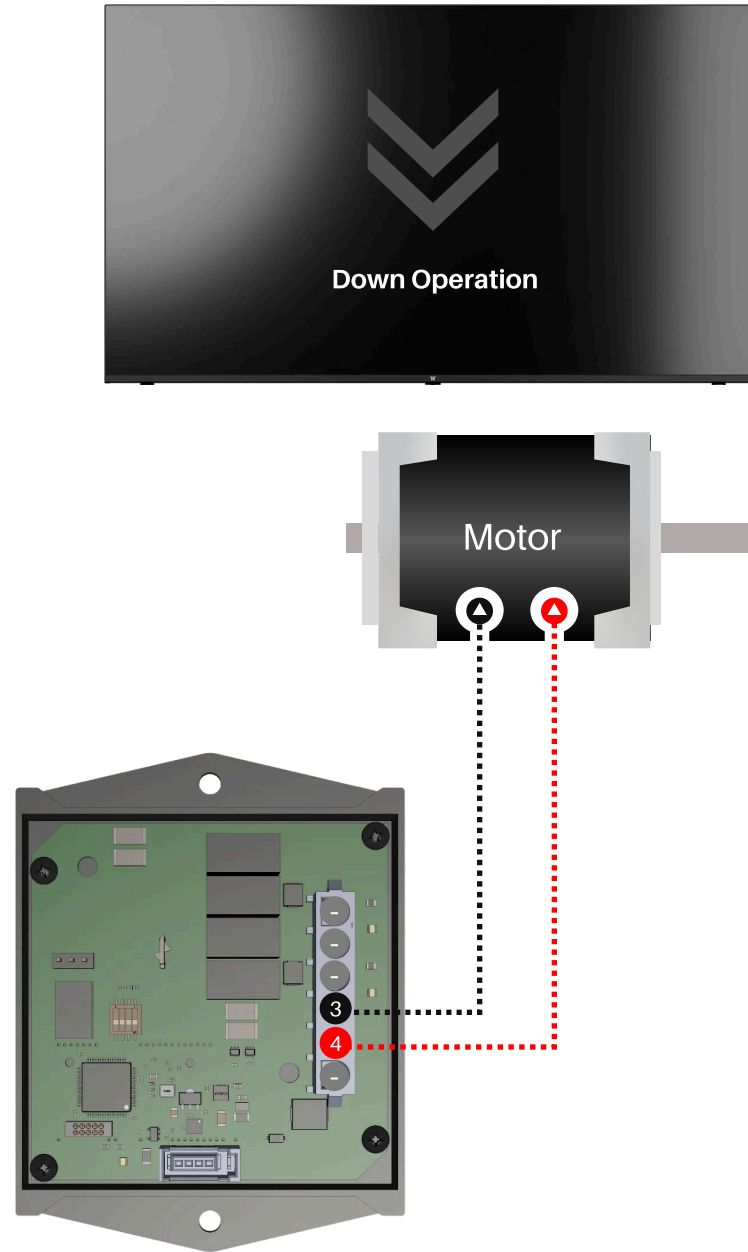
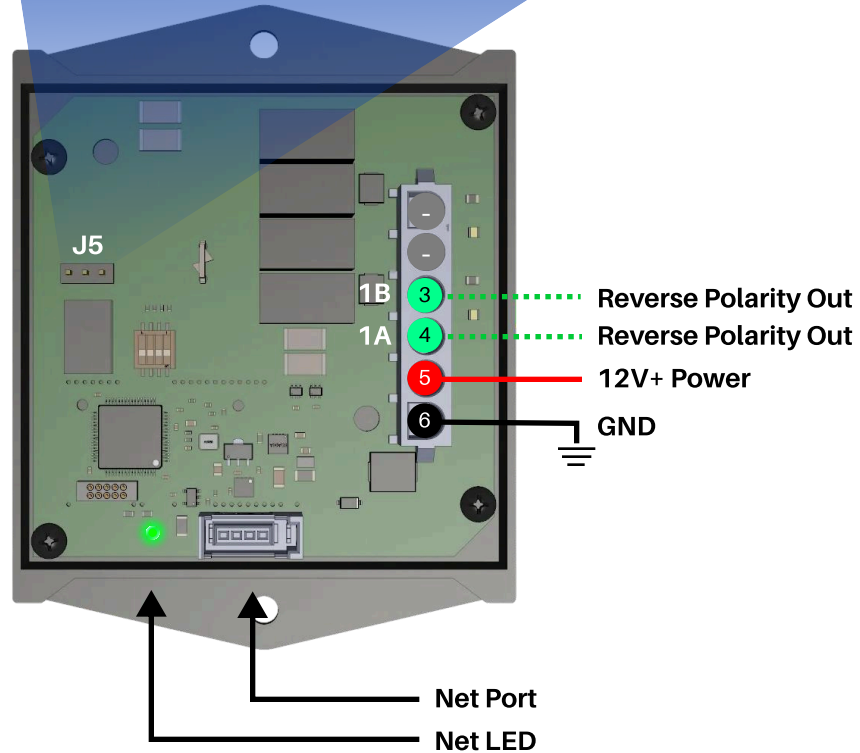

Trouble Shooting

This information applies **only to coaches with a MoRyde TV Lift**. The module shown above is an HCR-15, which provides the reverse-polarity output needed to drive the MoRyde TV Lift motor. If the TV lift will not raise or lower, first check that the **NET LED** on the **HCR-15** is solid green.

- If it is flashing or off, there is a network connectivity issue.
- If the module is online (solid green LED) but the TV lift still does not work, test the output with a multimeter.

Insert one probe into **1A** and the other into **1B**. Proper operation will show the module outputting **12V+** on one pin and ground on the other, depending on the direction. If this is not occurring, please call **Spyder Controls**.

Whisper Ride TV Lift

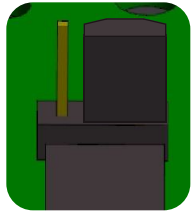
TV Lift	Location Settings
	The location setting for the HCR-15 can be changed via connector J5.

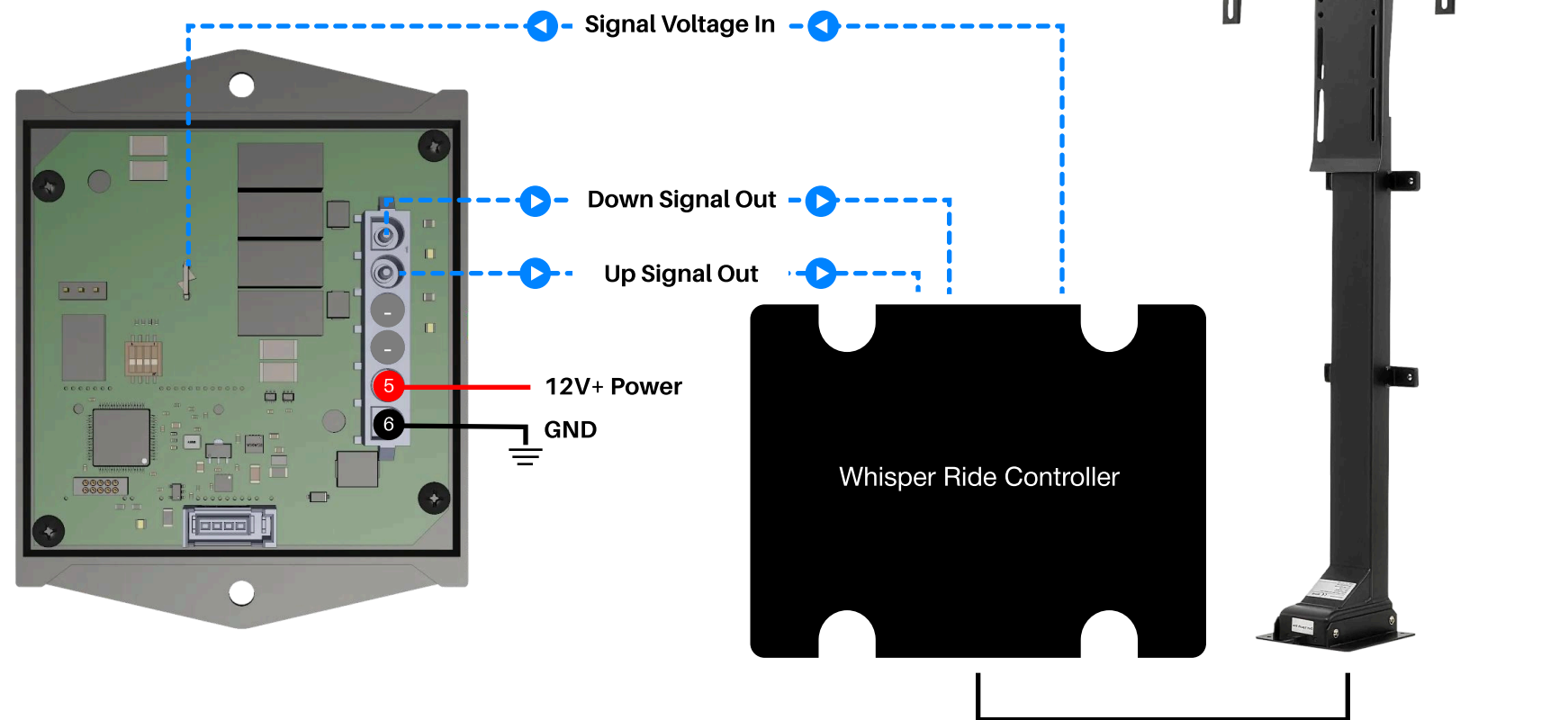
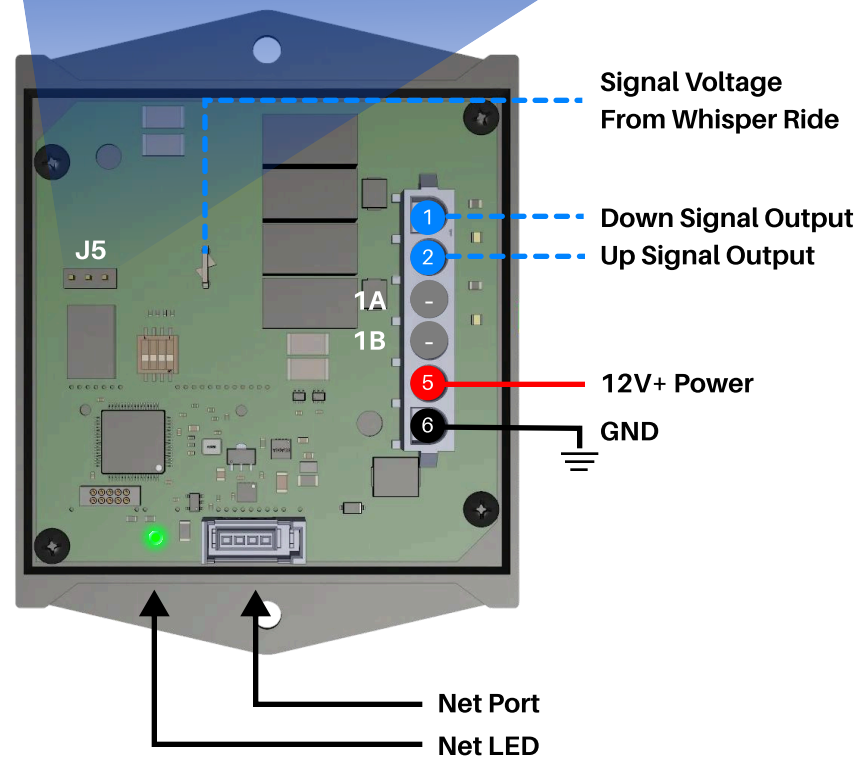

Trouble Shooting

The module shown below is an **HCR-15**, which provides the **12V** output for the TV lift motor. If the TV lift will not raise or lower, first check that the **NET LED** on the **HCR-15** is solid green.

- If it is flashing or off, there is a network connectivity issue.
- If the module is online (solid green LED) but the lift still does not operate, use a multimeter to probe the connector.

For further troubleshooting, please contact **Spyder Controls**.

Motors And Pump

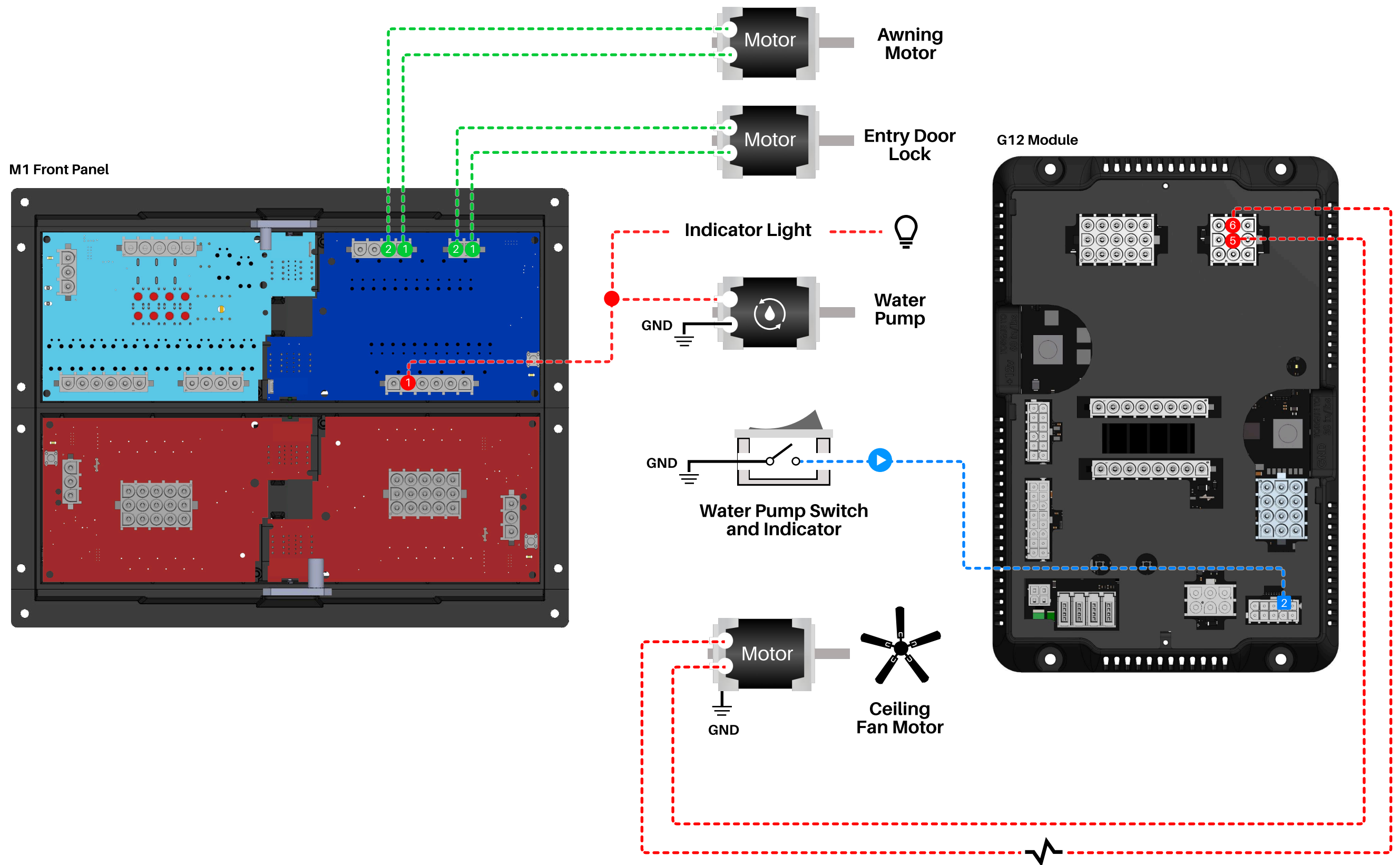

Fan Low Resistor - Tiffin P/N: 5040707

Tank Sensing

G12 Module



LPG Tank

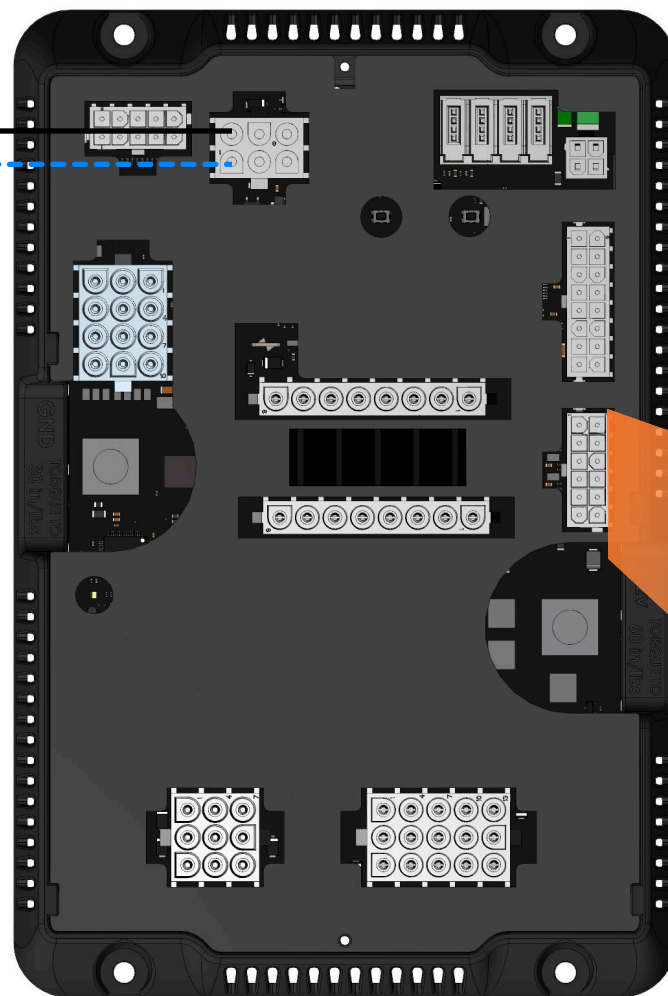

J11	Fresh Tank Sensor Input	1
▲	Grey Tank Sensor Input	2
	Black Tank Sensor Input	3
	Tank Sensor GND	9
	Tank Sensor GND	10
	Tank Sensor GND	11

Three Level Tank Sensor System

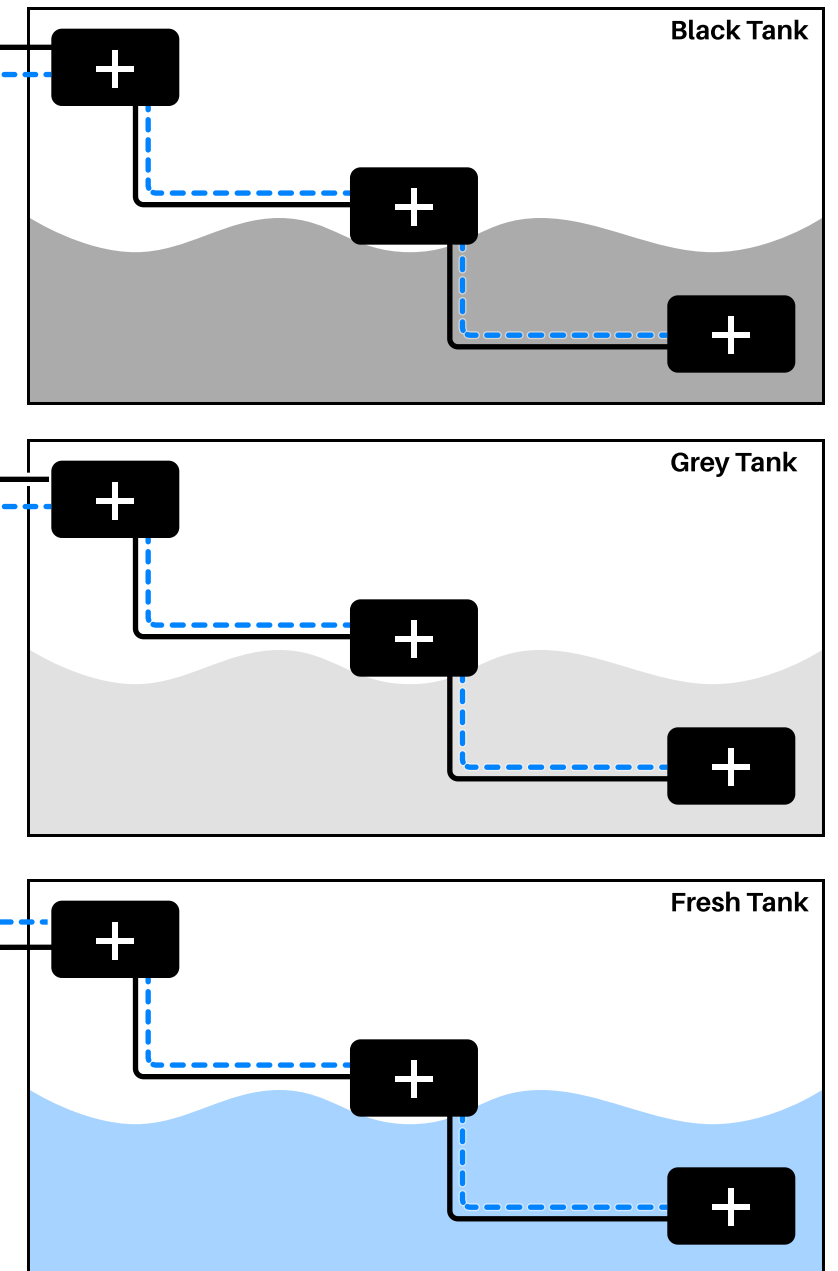

Tank Sensing

The **LPG Tank** sensor provides a **resistance value** to the G12 module. This resistance value ranges from **Full (90 Ohms)** to **Empty (0 Ohms)**. This level can be measured at the G12

Climate Systems

HVAC Aircons - RED

Front AC

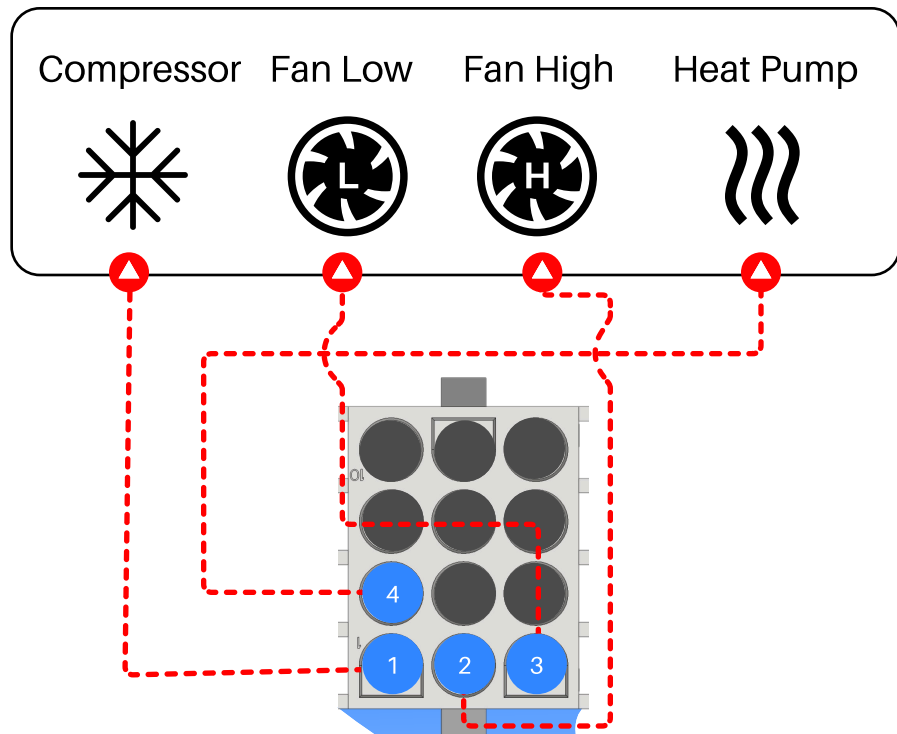

Mid AC

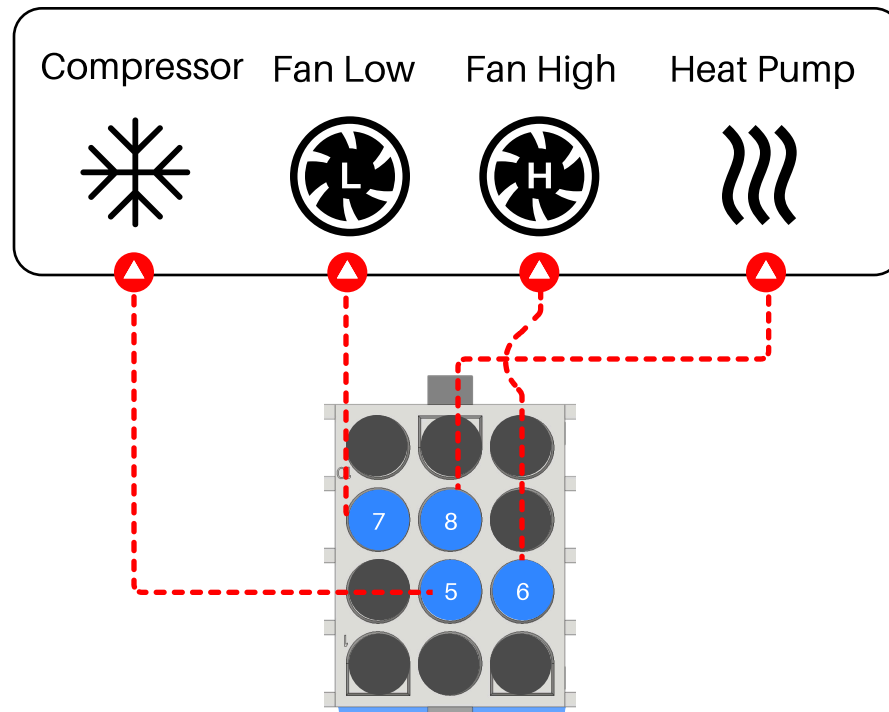

Rear AC

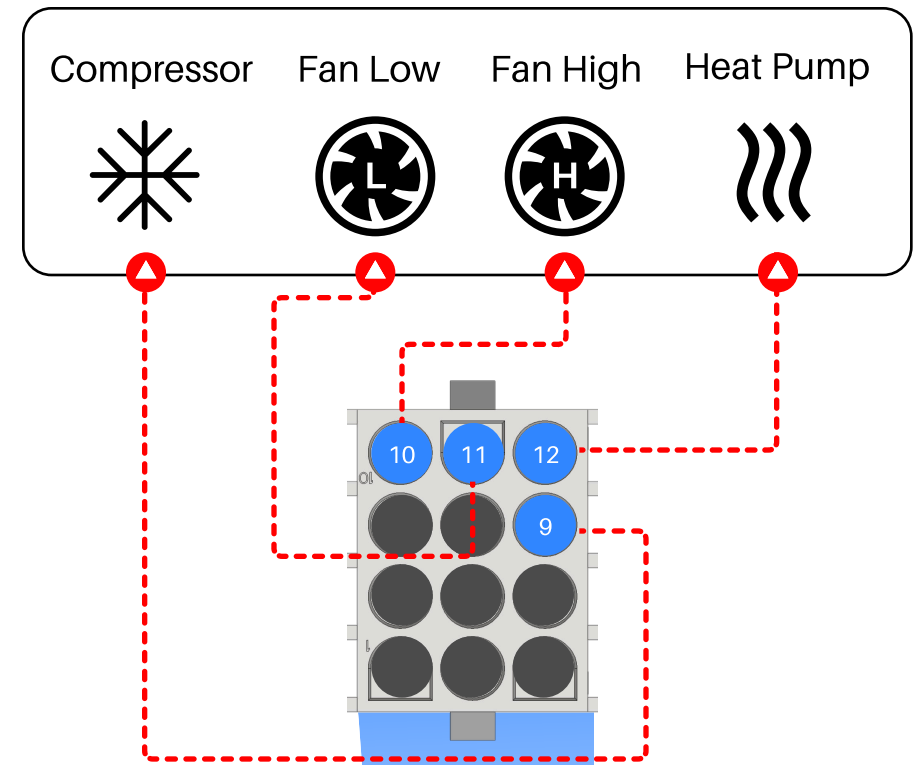

G12 Module

- FR A/C Compressor 1
- FR A/C Fan Hi 2
- FR A/C Fan Lo 3
- FR A/C Heat Pump 4
- Mid A/C Compressor 5
- Mid A/C Fan Hi 6
- Mid A/C Fan Lo 7
- Mid A/C Heat Pump 8
- RR A/C Compressor 9
- RR A/C Fan Hi 10
- RR A/C Fan Lo 11
- RR A/C Heat Pump 12

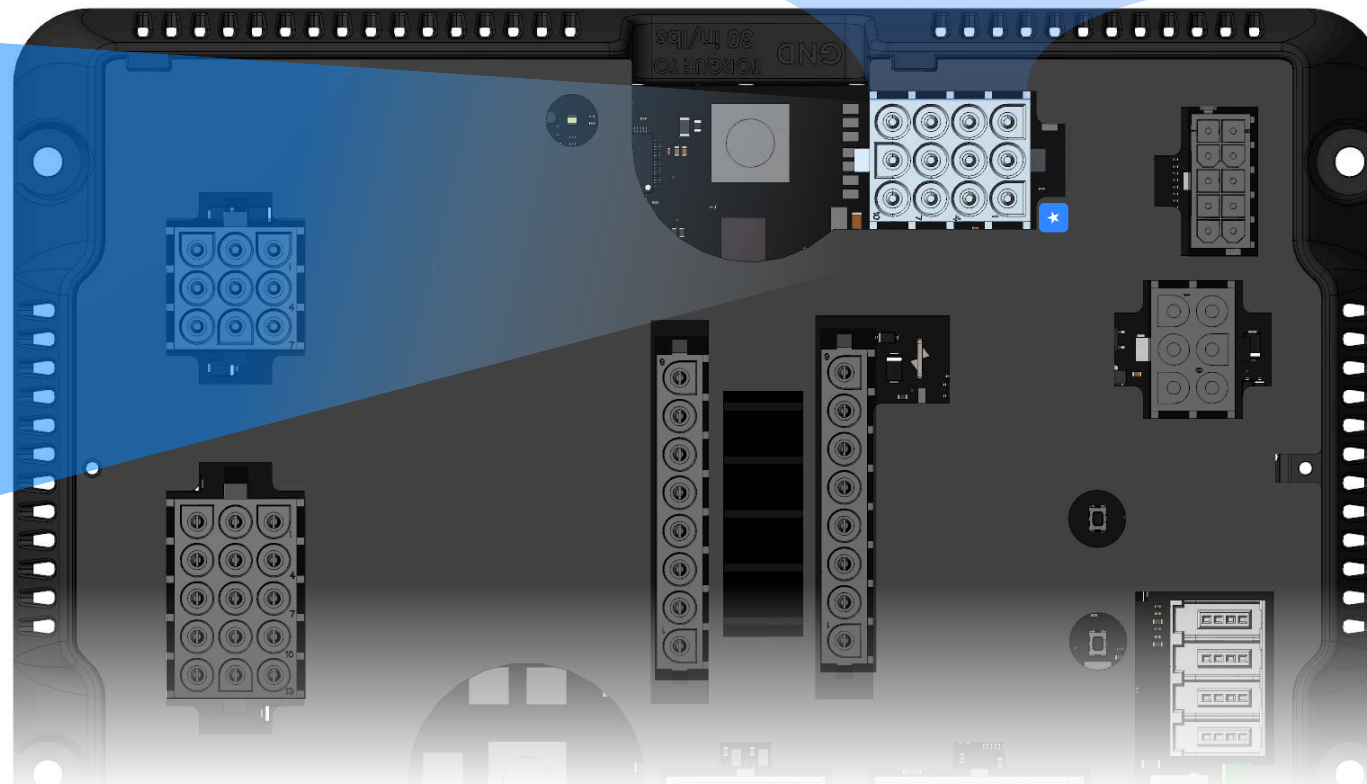

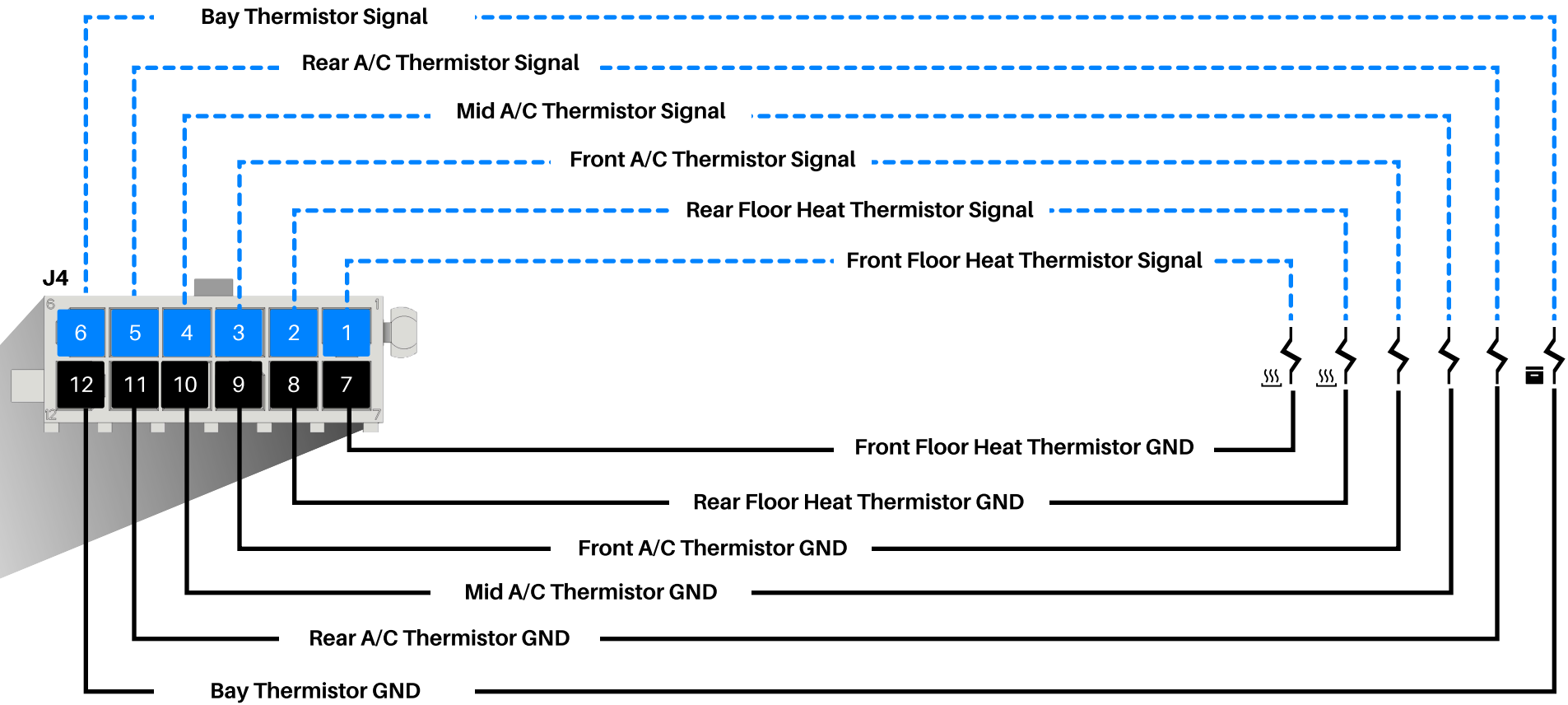
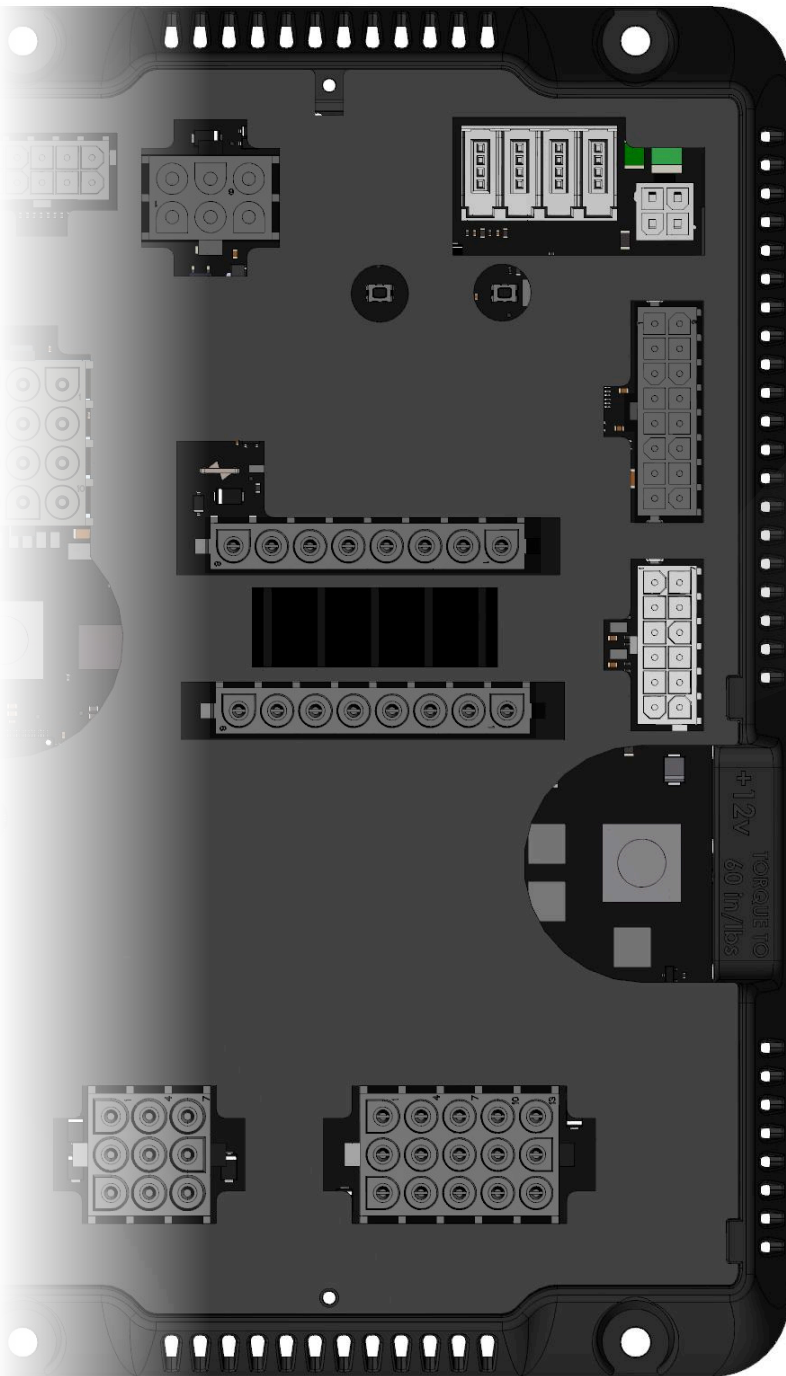

HVAC Thermistors - RED

G12 Module



 HVAC Thermistor
100K Ohms at 25C / 77F

 Floor Heat Thermistor
10K Ohms at 25C / 77F

 Bay Thermistor
100K Ohms at 25C / 77F

As the temperature increases
resistance **lowers**.

Floorheat

Floorheat Set Points

The floor heat system in your coach operates using **levels (1-5)**. Each level corresponds to a specific temperature range. The system heats the floor pad until the selected level is reached, then shuts off and monitors the floor temperature. It will turn back on **automatically** whenever additional heat is needed.

To power a heating pad, a channel in the floorheat HCR-15 turns on and **sends 12V+** to a **GFCI outlet** in the rear closet. This activates the **120V AC** outlet, which then supplies power to the heating pad.

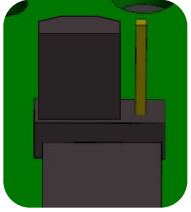
Floorheat	Location Settings
	The location setting for the HCR-15 can be changed via connector J5.

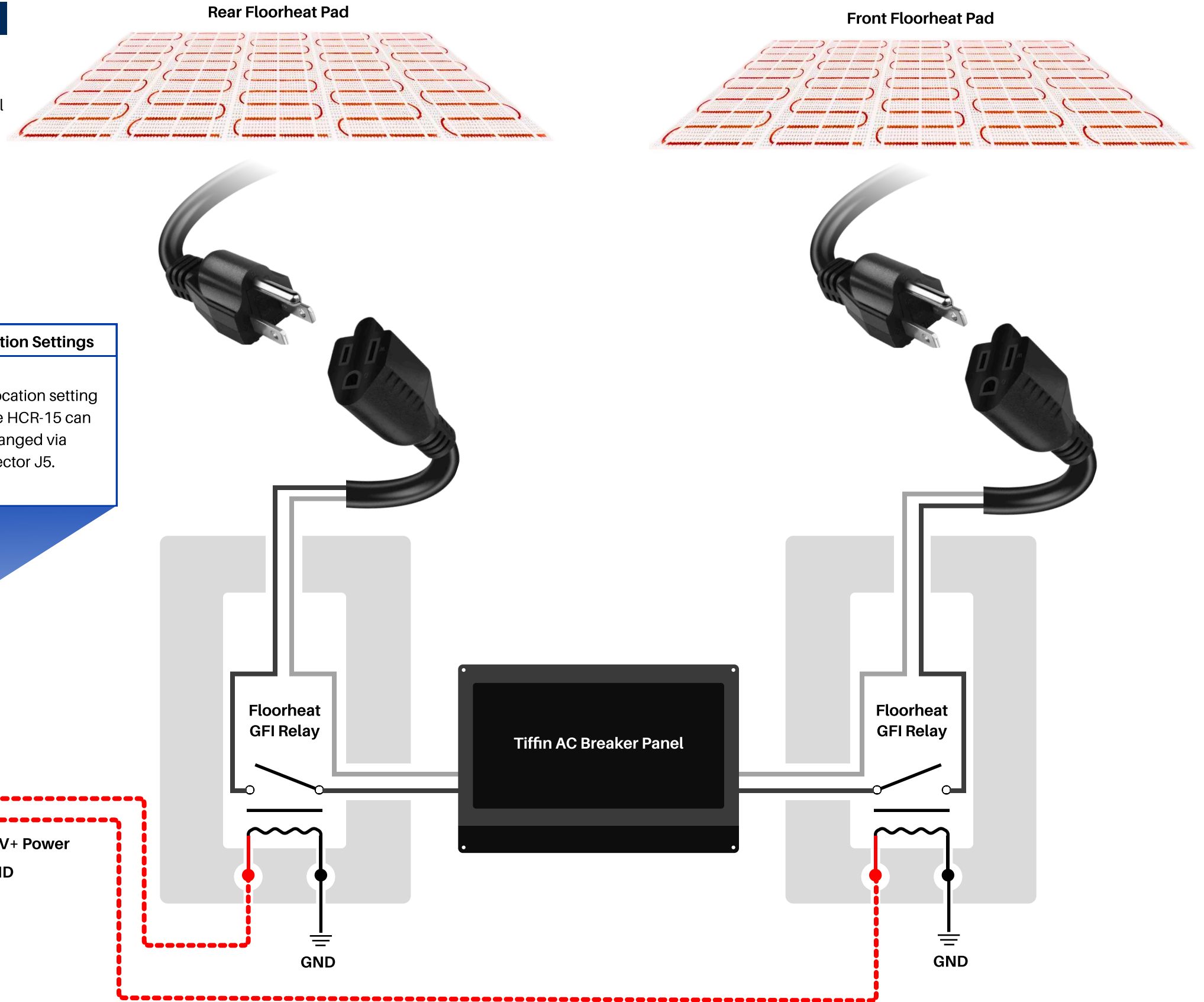
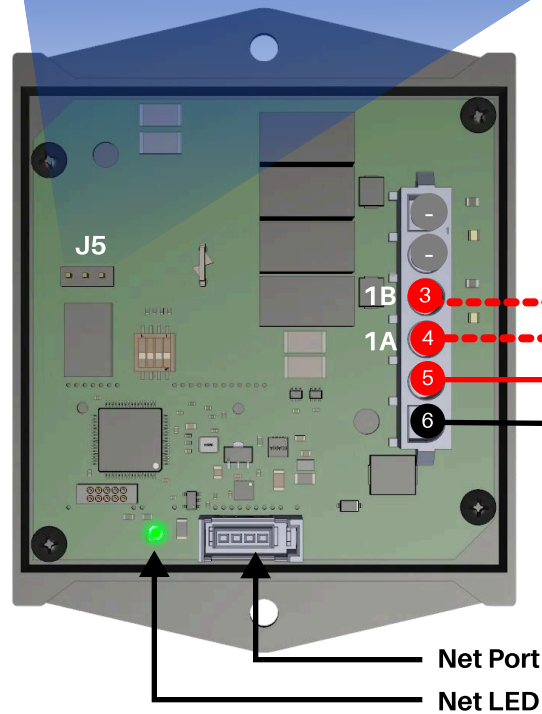

Vent Fans - Maxxfan

Vent Fan Modules - Located in Vent Fans - 1 Per Vent Fan

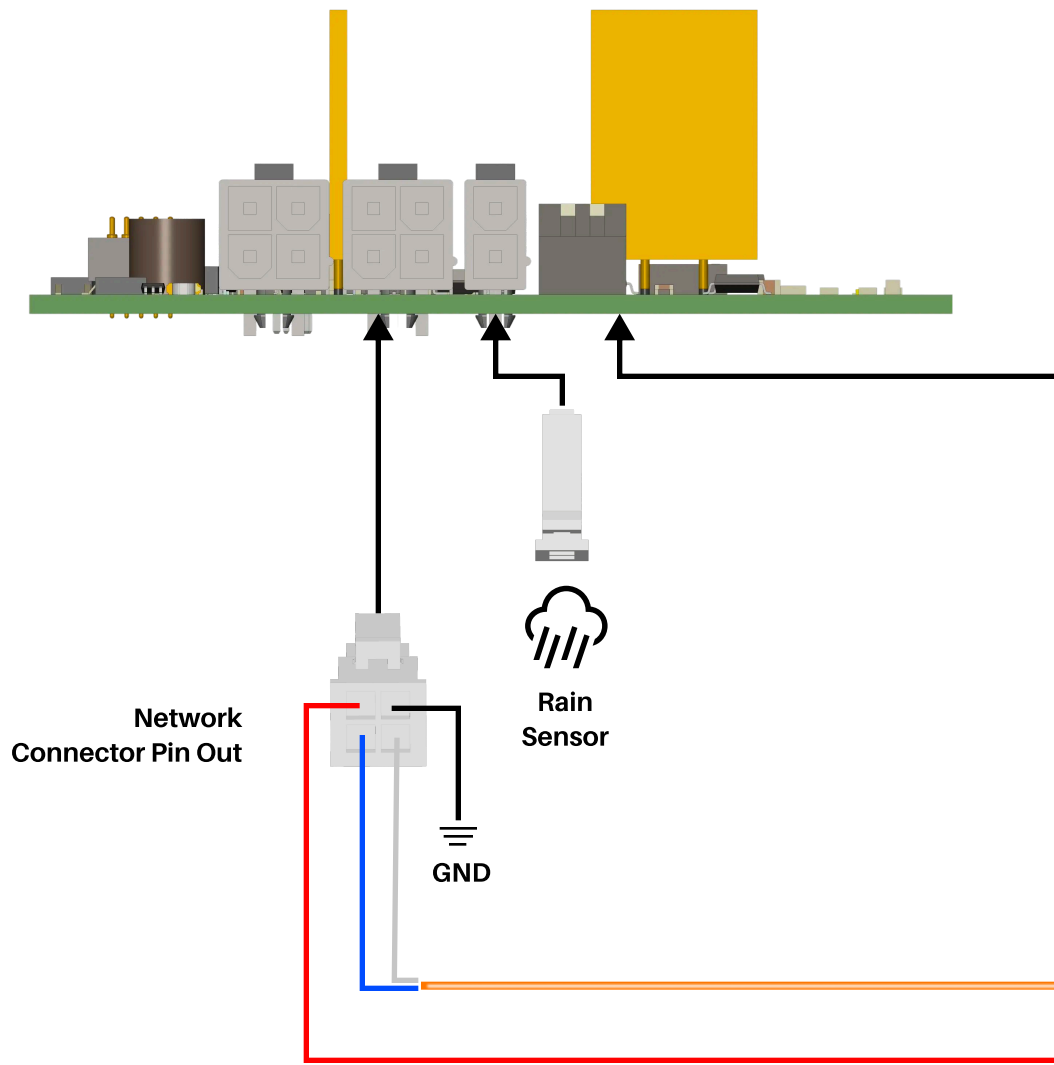

Dip Switch Settings	
Fan Location	Dip Switch Setting
Galley Fan	
Mid Bath Fan	
Rear Bath Fan	

G12 Module

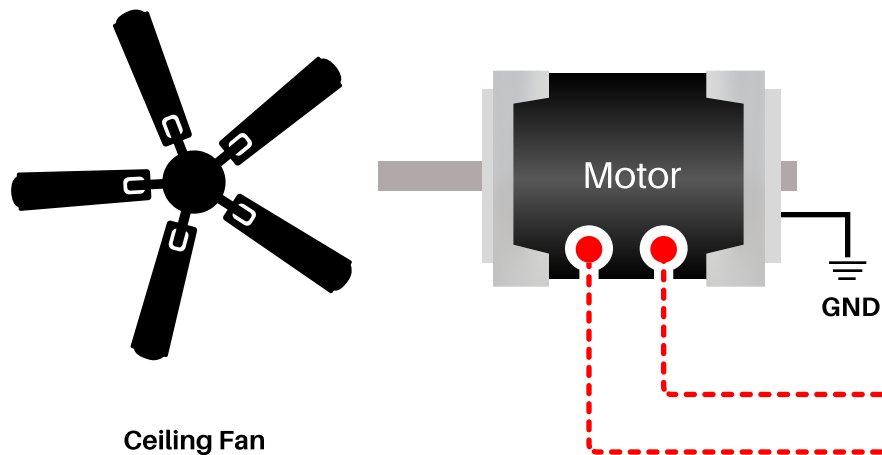
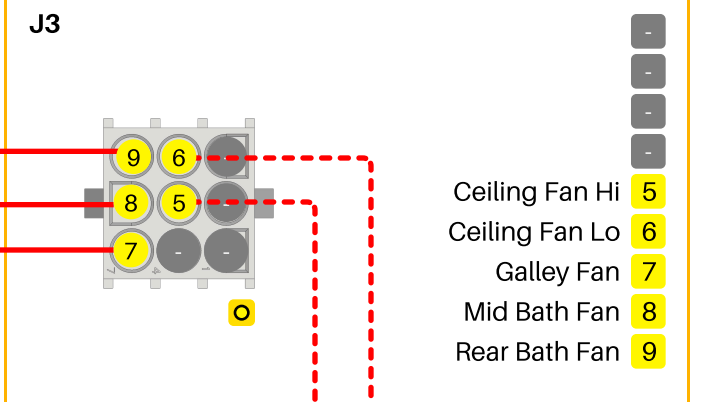
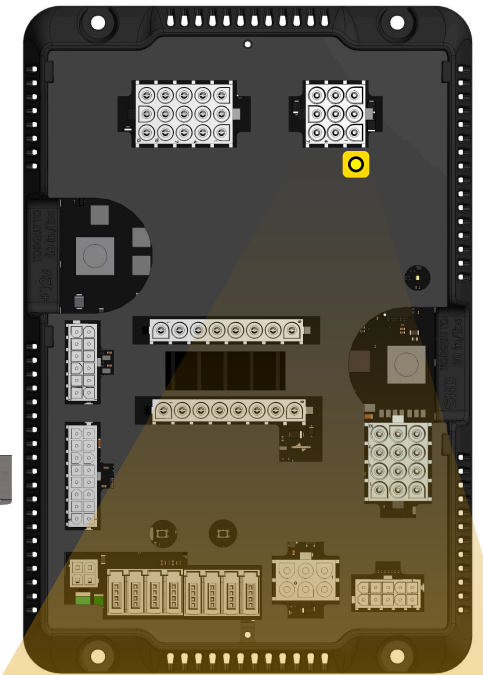

Fan Low Resistor - Tiffin P/N: 5040707

Vent Fans - Non-Maxxfan

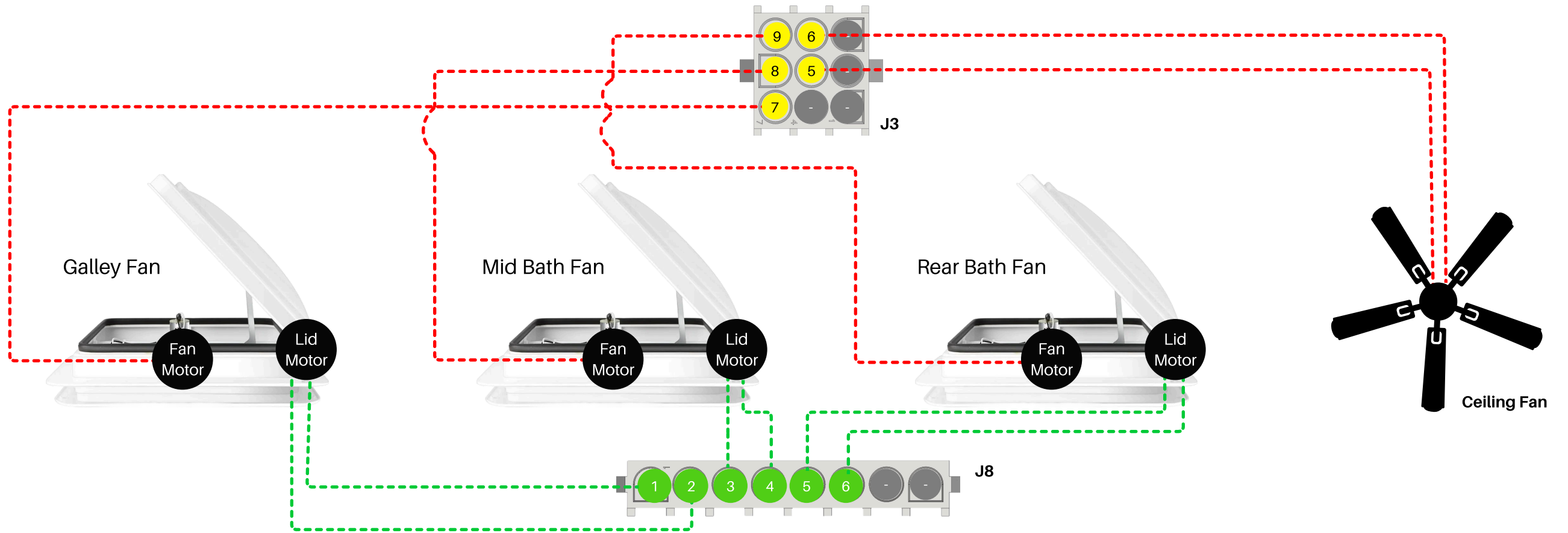

- 1 Galley Fan Lid Up
- 2 Galley Fan Lid Down
- 3 Mid Bath Fan Lid Up
- 4 Mid Bath Fan Lid Down
- 5 Rear Bath Fan Lid Up
- 6 Rear Bath Fan Lid Down
- 7 Front Furnace Trigger
- 8 Rear Furnace Trigger



- Ceiling Fan Hi 5
- Ceiling Fan Lo 6
- Galley Fan 7
- Mid Bath Fan 8
- Rear Bath Fan 9

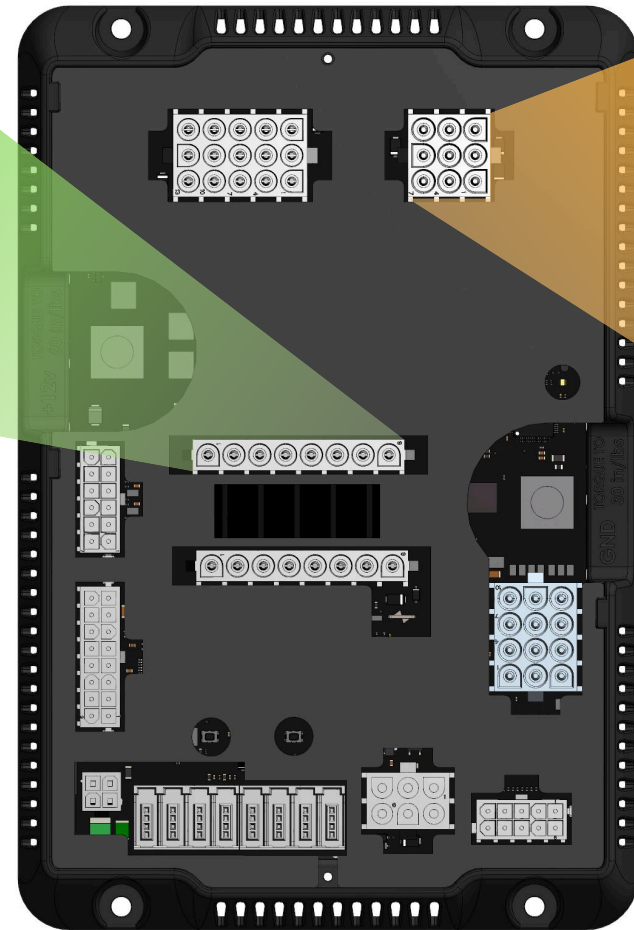
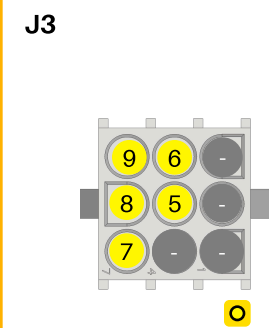

Power Systems

HCR-11 - Drop Tap

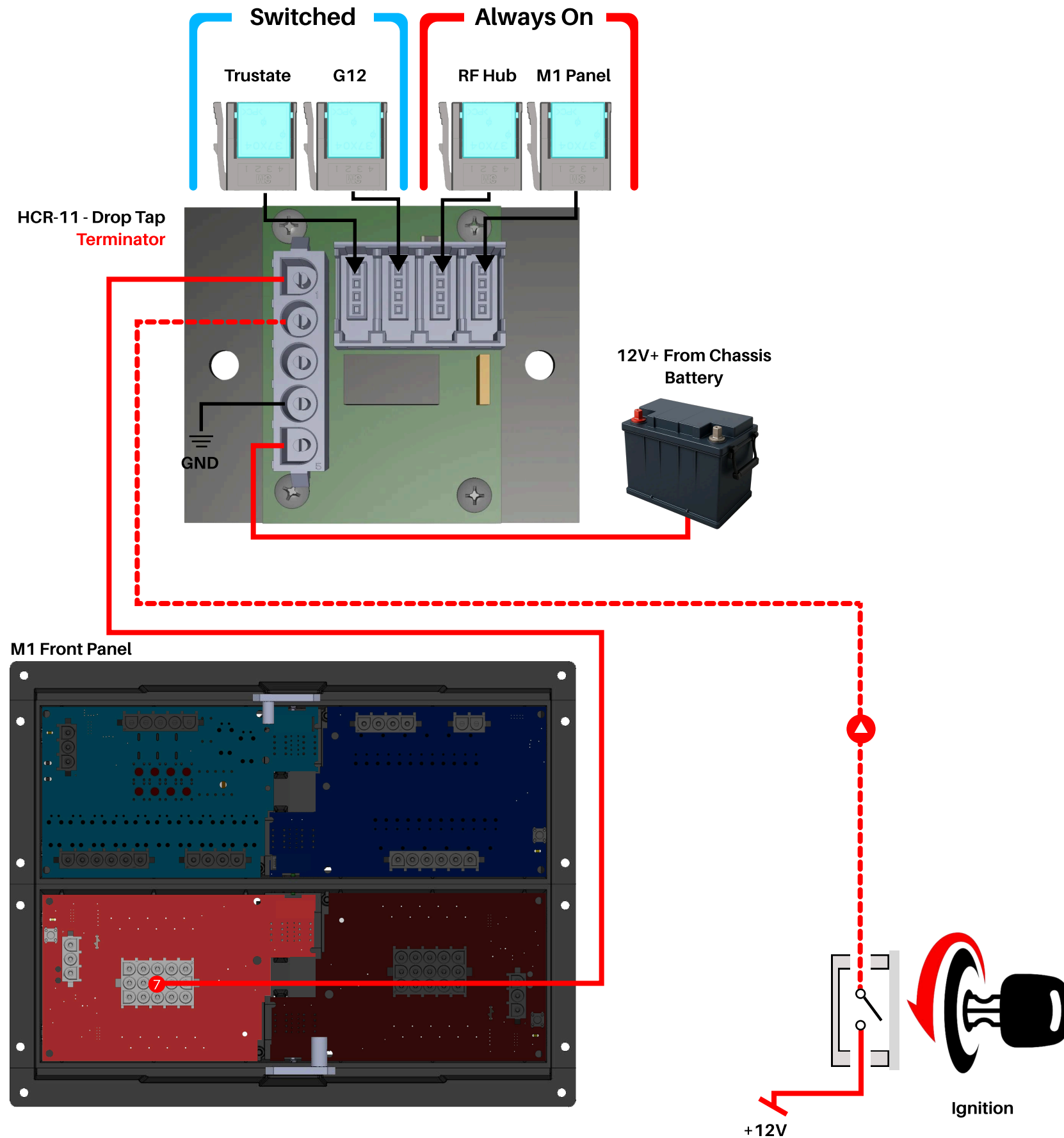

Battery Merge - RED

Coach Running Input

Depending on the chassis used in the coach, the coach running input will come from either the engine (switched GND input) or the ignition (switched 12V+ input).



Ignition



Engine Run

G12 Module

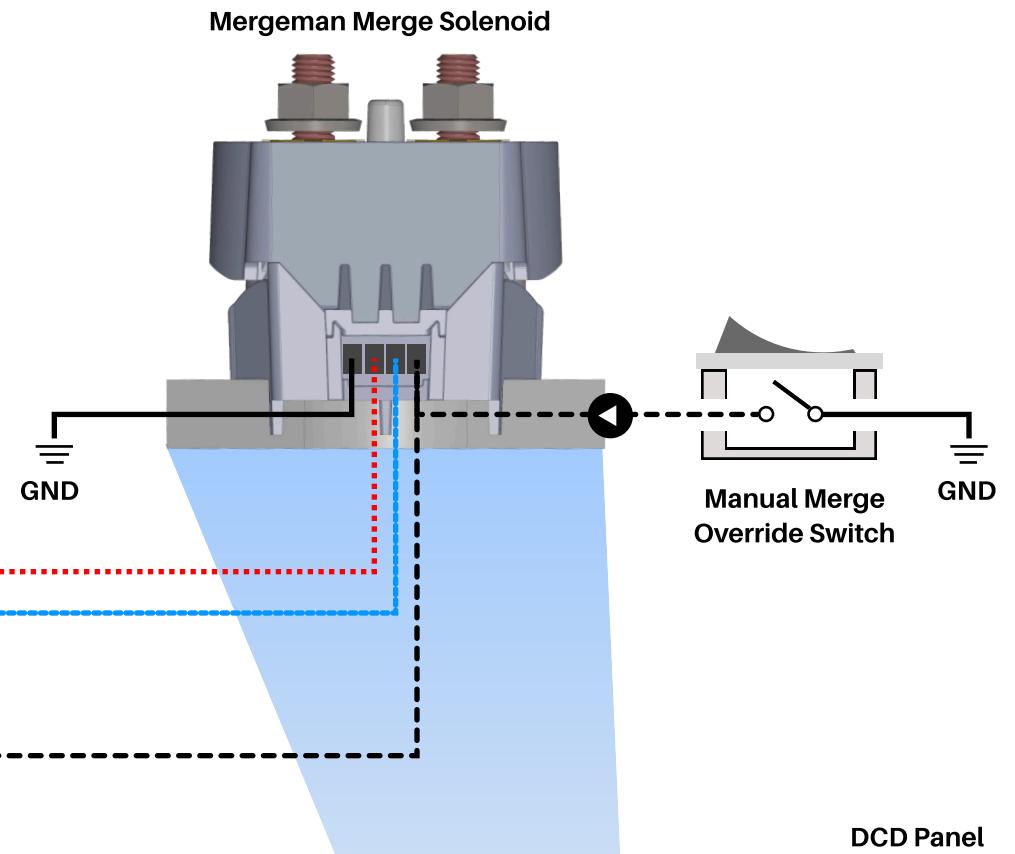
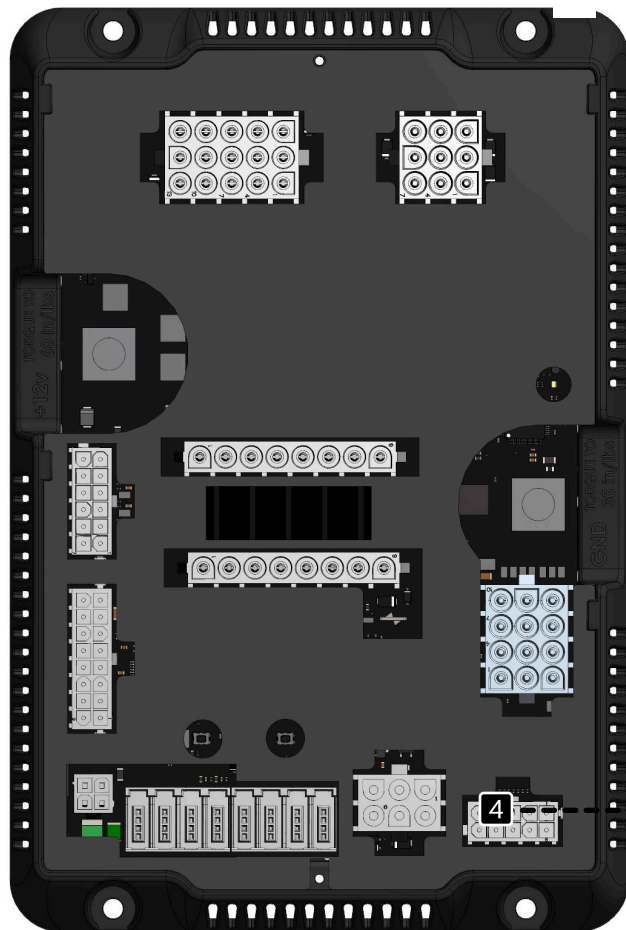

Mergeman Merge Solenoid

Manual Merge Override Switch

DCD Panel

Auto / Manual Merge Input (GND)

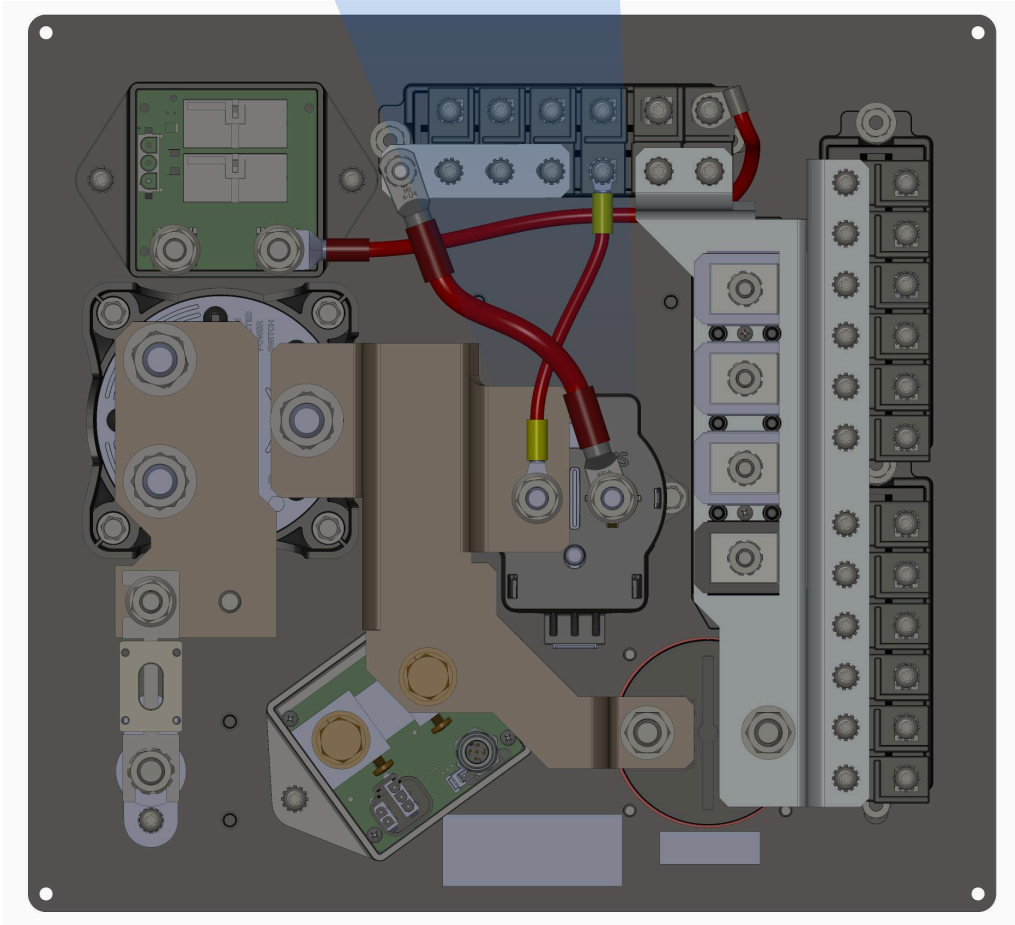

Merge Logic

What is Battery Merge?

Battery merge is a system that allows your house and chassis battery to share power ensuring both are sufficiently charged in all situations.

Chassis Charging House State

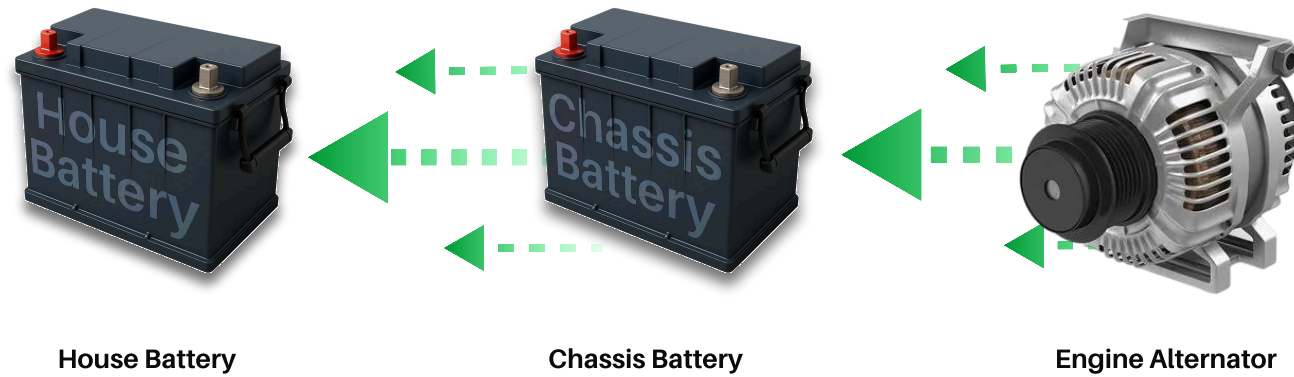

The merge solenoid will **engage** if the following conditions are present:

- Engine run or **ignition** signal is **present** and **chassis voltage** is **above 13.3 V** (Charging) for **30 seconds**

The merge solenoid will **disengage** under either of the following conditions:

- Engine run or **ignition signal** is **removed**
- **Chassis voltage** drops **below 12.6V** for more than **30 seconds** (unmerge until engine started again)

House Charging Chassis State

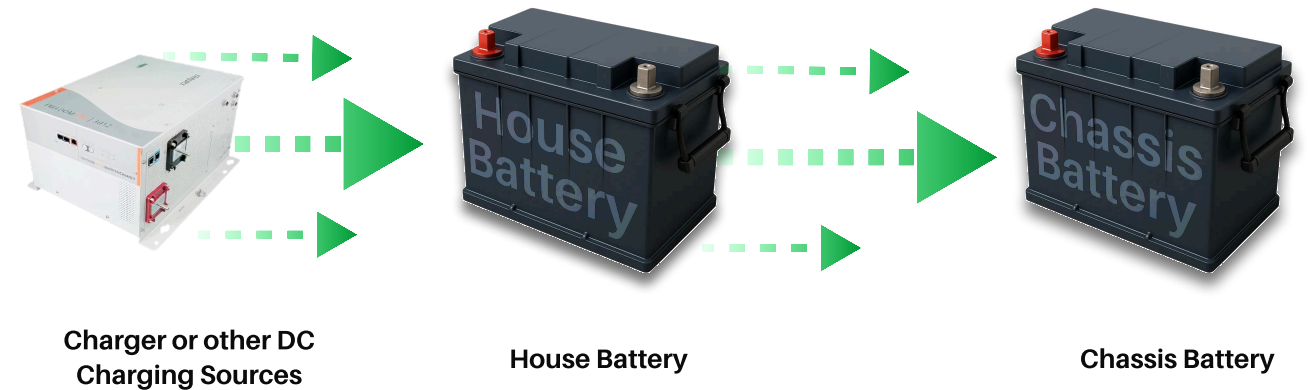

The merge solenoid will **engage** if the following conditions are present:

- The **House Voltage** is **above 12.5V** (Charging) and **Chassis Voltage** is **below 12.4V** (low Battery Voltage) for **30 seconds**.

The merge solenoid will **disengage** under either of the following conditions:

- **House Voltage** drops **below 12.2V** for more than **30 seconds**. **OR**
- The **60 minutes** timed battery **merge** period **expires**. **Re-merge** will occur again if the merge conditions are still present.



- The **voltages** listed in this spec are **measured directly** at the **merge solenoid** located in the DCD panel. These **readings** may **differ** from the **voltages shown** on the **LCD** screens, which are provided for general reference.

Generator

Generator

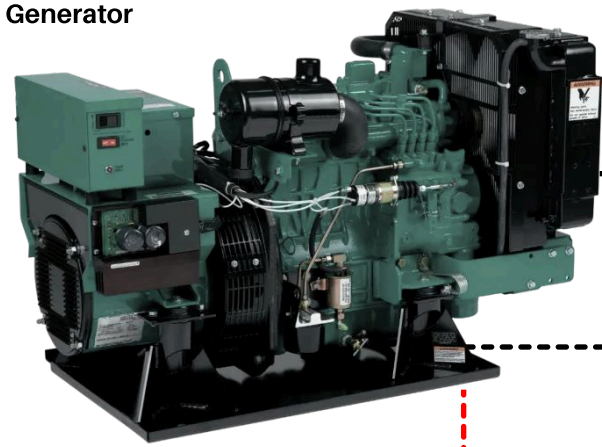

Gen Start (GND)

Gen Stop (GND)

Gen Run Signal (12V+)

G12 Module

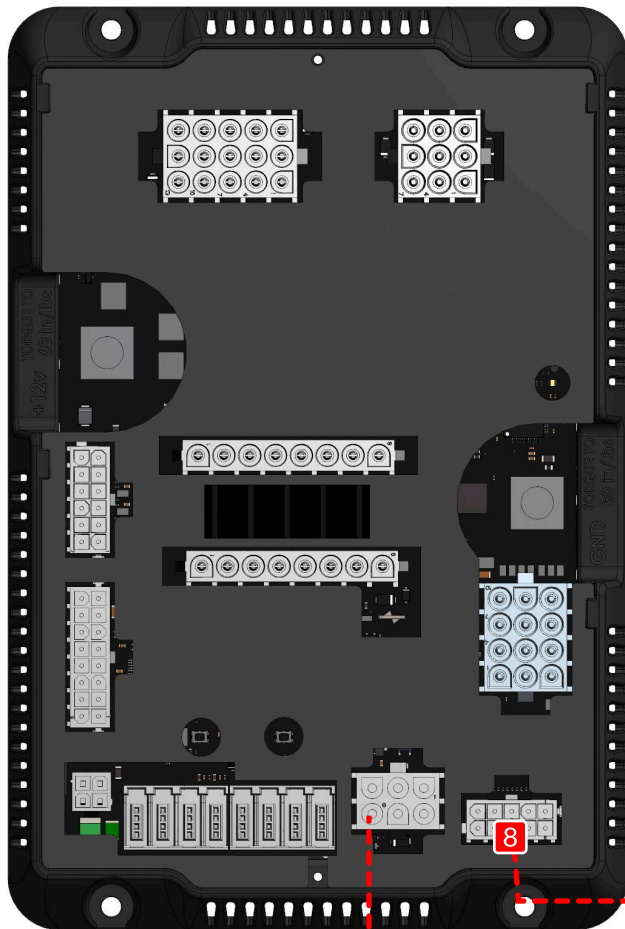

Shore Power Detection

M1 Panel

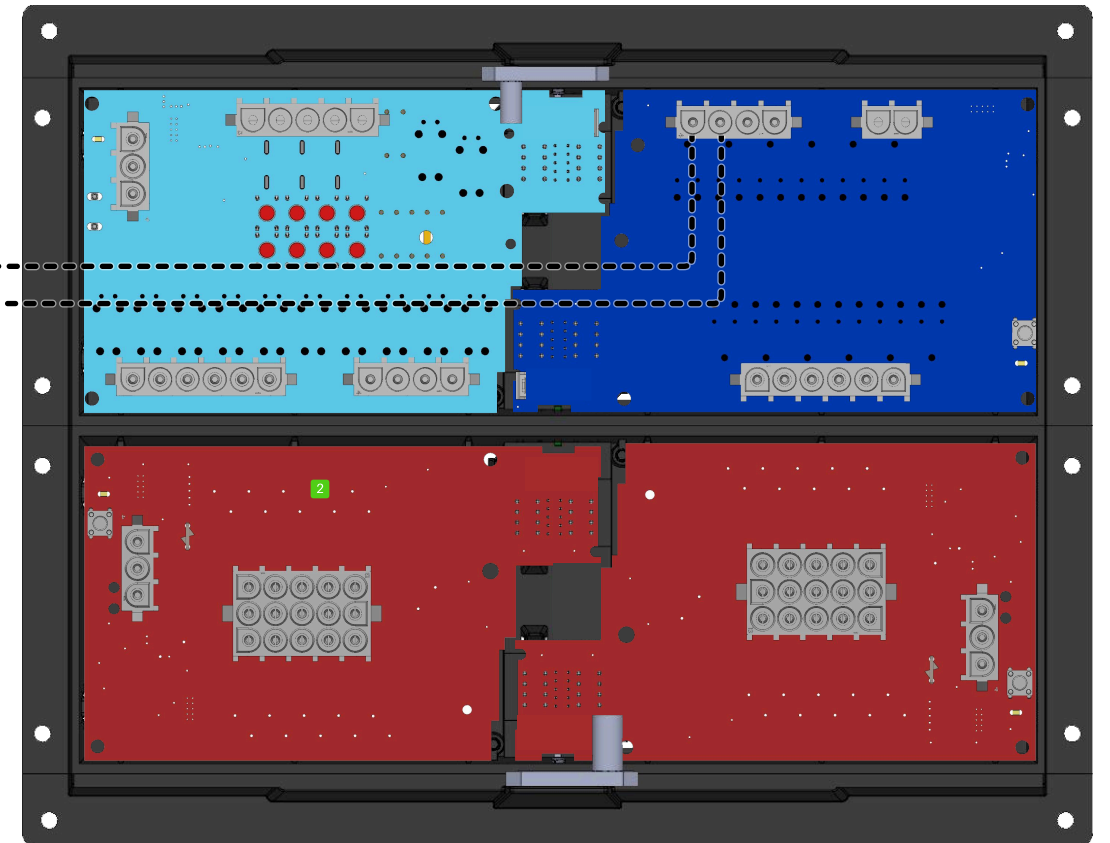

Operating the Generator

The generator can be started by using the generator start/stop switch on the dash or by activating it from any Spyder Screen.

The AGS (Auto Generator Start) can be set to automatically toggle the generator on or off based on user defined conditions.

Shore Power Detection

When the G12 receives +12V on connector J5, pin 8 (shore power detect), AGS will remain off until shore power is disconnected.



DCD Panel - RED

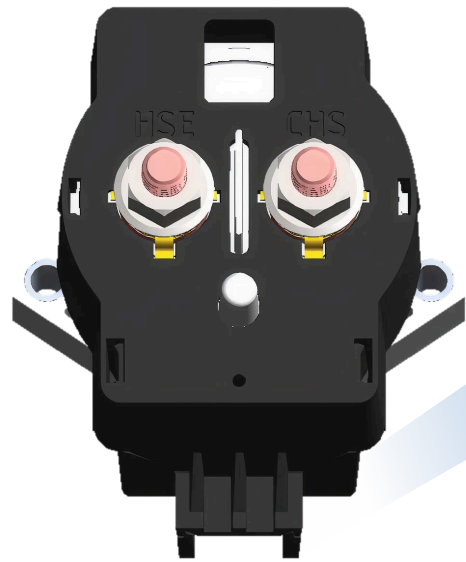

Mergeman

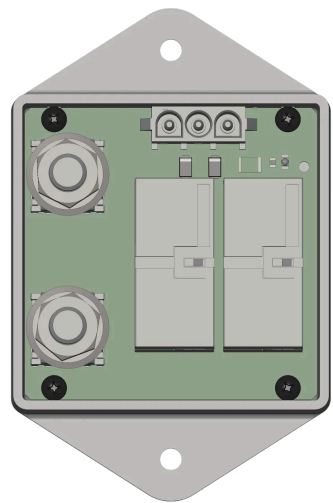
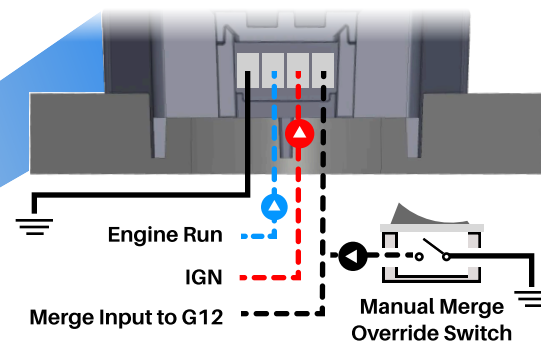

BDC3

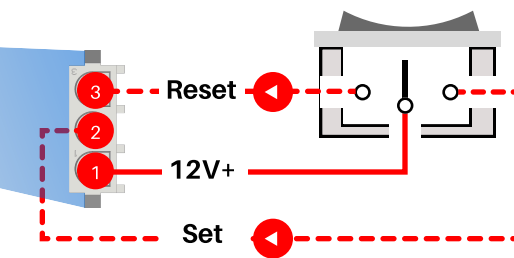

The **BDC3** module **shuts off house power** to the **G12 Module** when the battery switch is toggled at the entry way 5" panel.

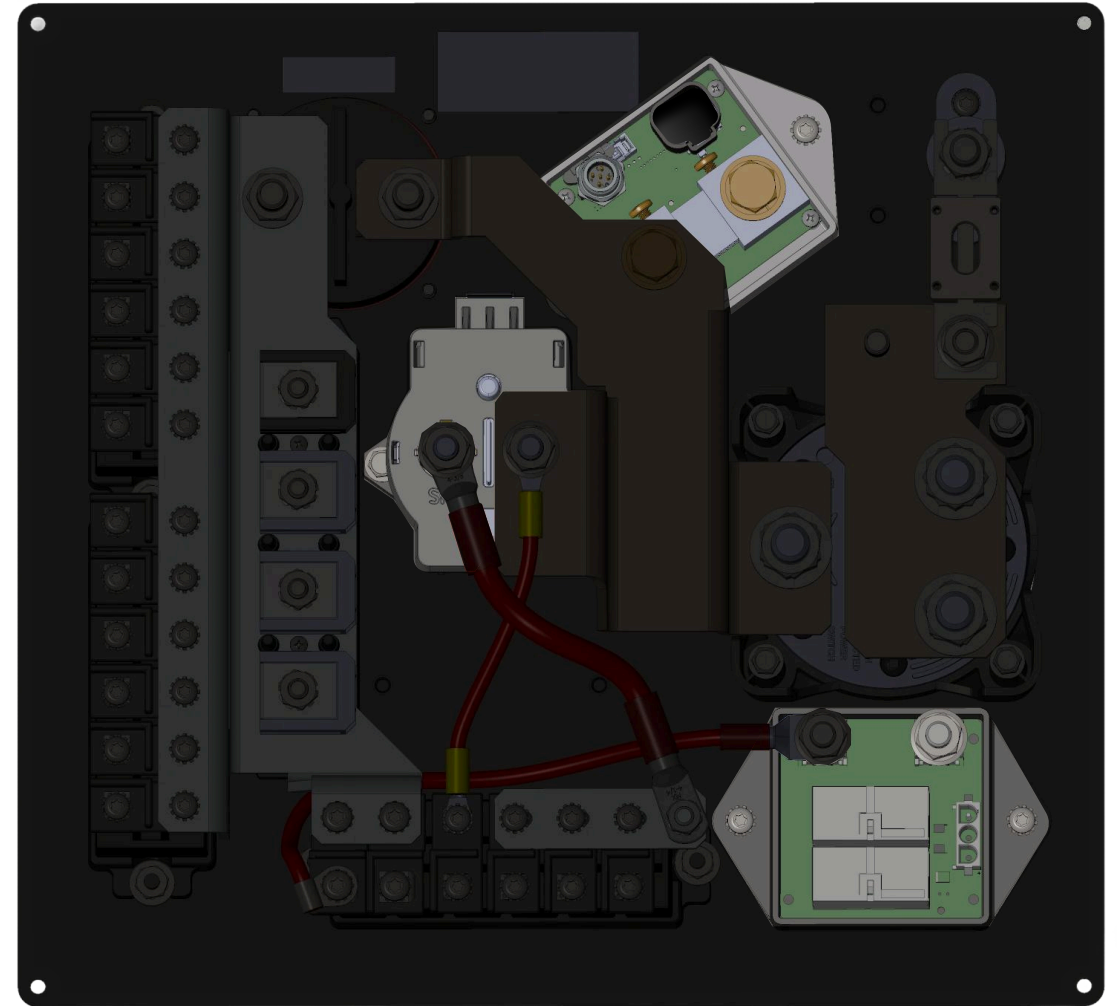

DCD Panel

The DCD panel serves as the central hub for high-current DC power distribution. It has several compact, intelligent modules mounted to it, as shown to the left.

Trustate Module

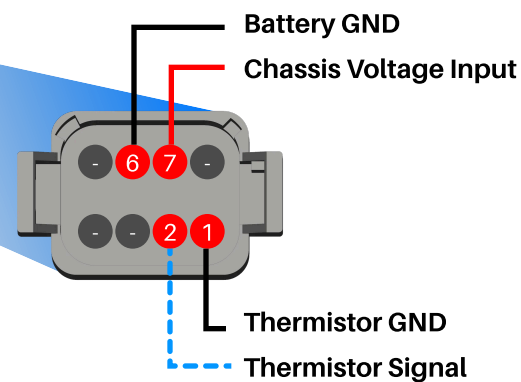

The Trustate provides the following information:

- Current in Amps (In/Out) of the House Batteries
- House battery voltage
- Chassis battery voltage
- House battery temperature

The Trustate only provides battery information. It does not determine when or if to charge the batteries.

Spyder Network

Network Modules - RED

G12 Module

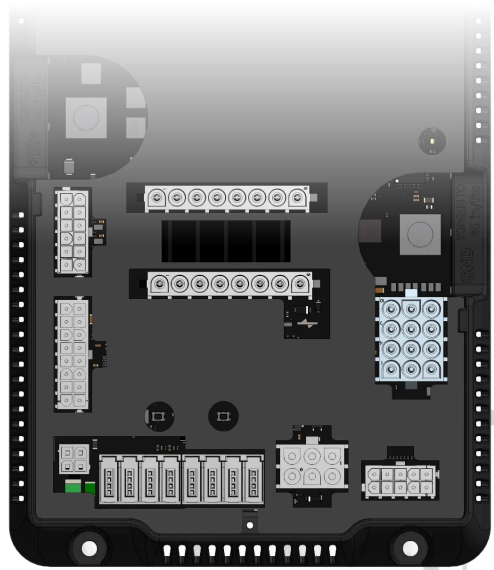

M1 Panel

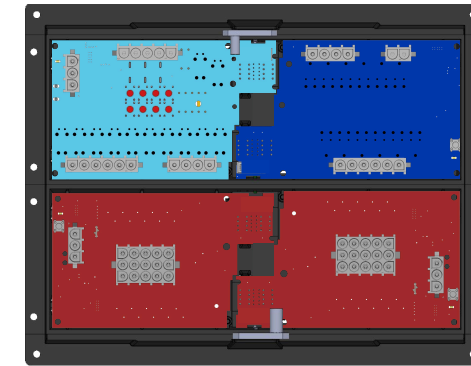

Trustate in DCD Panel



Terminator - HCR-11 Drop Tap

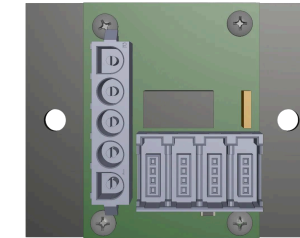

Network Tap

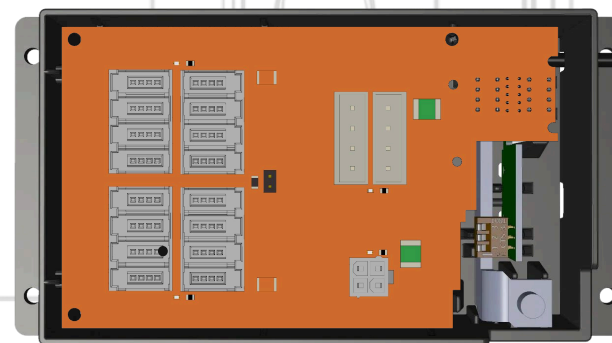

Mira Module



RF Hub

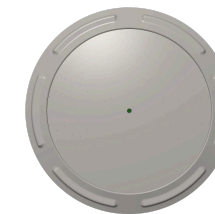

Truma Bridge Module (Optional)

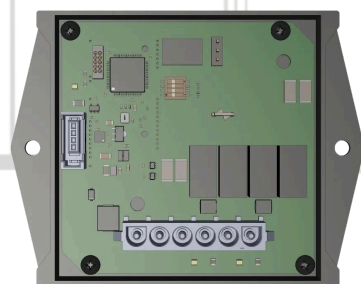

Aqua-Hot Module (Optional)



TV Lift HCR-15

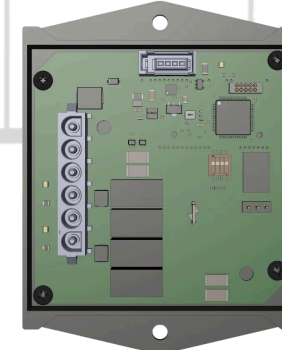

i Only one water heater will be equipped in the coach. Both the Truma Water Heater and Aqua-Hot Water Heater require a network connection to operate.

The Truma requires a Truma Bridge module in addition to a network cable connection.

Floorheat HCR-15

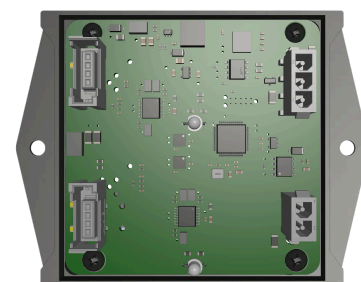

Network Modules - RED

G12 Module

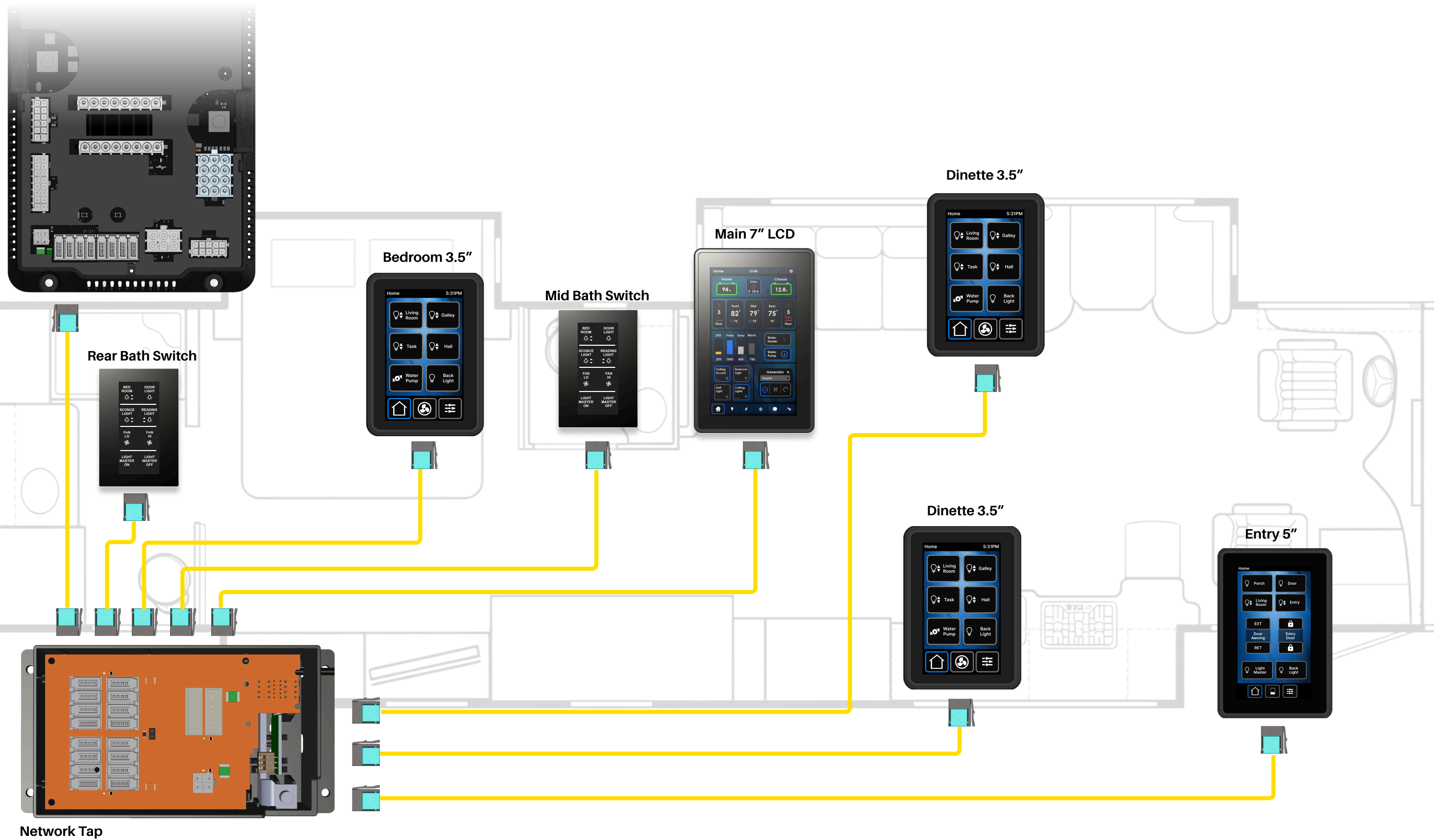

Always On Network - RED



- THE NETWORK CABLES INSERTED INTO THIS DROP TAP MUST BE IN ORDER. THE ITEMS ON THE RIGHT ARE ALWAYS ON. THE ITEMS ON THE LEFT TURN OFF WHEN THE BATTERY DISCONNECT IS TOGGLED. SWAPPING THE NETWORK CABLES AT THIS TAP WILL CAUSE ISSUES.

G12 Module

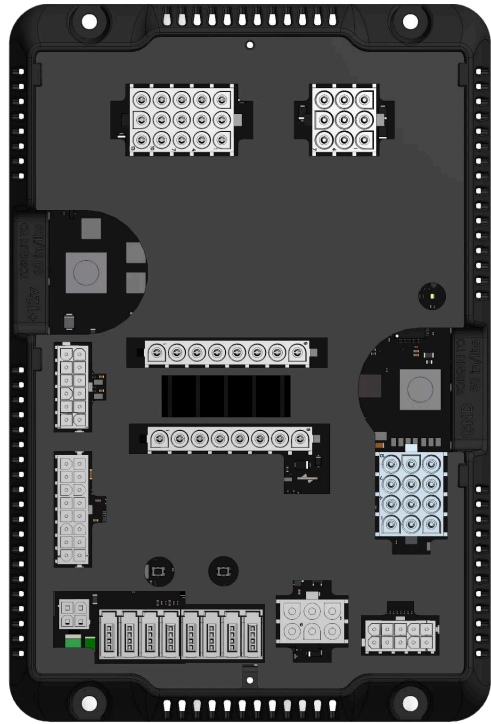

Terminator - HCR-11 Drop Tap

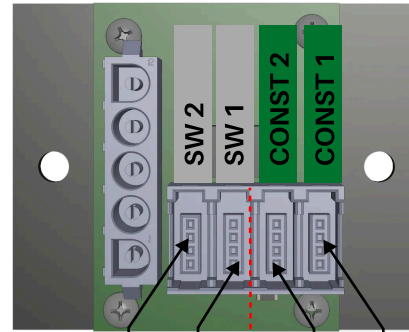

Switched

Always On

M1 Panel

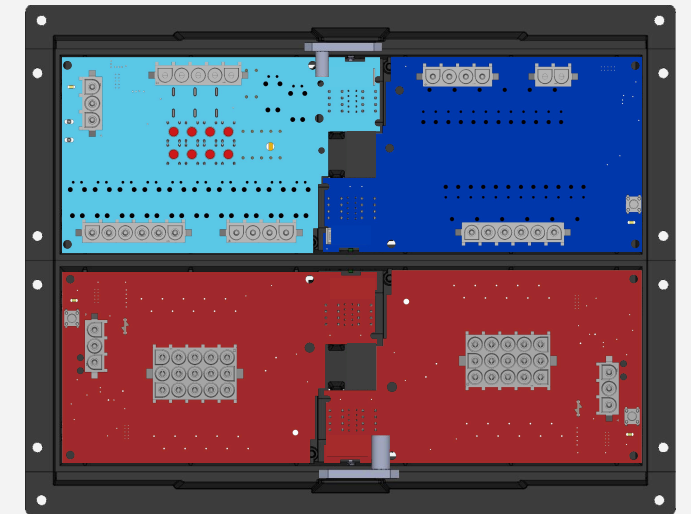

Trustate in DCD Panel

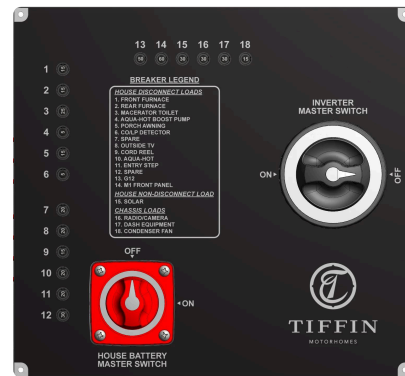
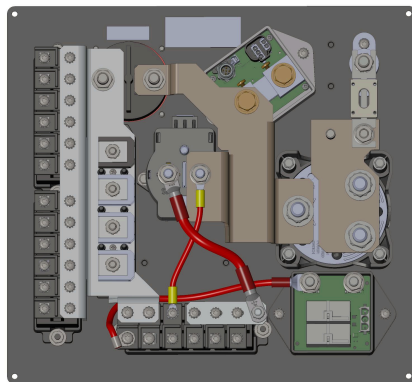

RF Hub

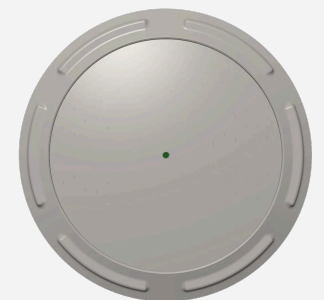

Additional Information

Connectors

Connectors		
 <p>Male Network End Spyder P/N: CON824204 Tiffin P/N: 5066157 Manufacture P/N: 37104-2165-000 FL 100</p>	 <p>12 Pos - Mini Fit Jr Connector Manufacture P/N: 770581-1 Matching Pin (16-20 AWG) Manufacture P/N: 171639-1</p>	 <p>3 Pos - Mate-N-Lok Connector Manufacture P/N: 350766-1 Matching Pin (14-20 AWG) Manufacture P/N: 350550-1</p>
 <p>Female Network End Spyder P/N: CON824204 Tiffin P/N: 5066157 Manufacture P/N: 37104-2165-000 FL 100</p>	 <p>16 Pos - Mini Fit Jr Connector Manufacture P/N: 770583-1 Matching Pin (16-20 AWG) Manufacture P/N: 171639-1</p>	 <p>4 Pos - Mate-N-Lok Connector Manufacture P/N: 350779-1 Matching Pin (14-20 AWG) Manufacture P/N: 350550-1</p>
 <p>4 Pos - Mini Fit Jr Connector Manufacture P/N: 0039013042 Matching Pin (18-24 AWG) Manufacture P/N: 0039000039</p>	 <p>18 Pos - Mini Fit Jr Connector Manufacture P/N: 770584-1 Matching Pin (16-20 AWG) Manufacture P/N: 171639-1</p>	 <p>5 Pos - Mate-N-Lok Connector Manufacture P/N: 643406-1 Matching Pin (14-20 AWG) Manufacture P/N: 350550-1</p>
 <p>8 Pos - Mini Fit Jr Connector Manufacture P/N: 770579-1 Matching Pin (16-20 AWG) Manufacture P/N: 171639-1</p>	 <p>2 Pos - Mate-N-Lok Connector Manufacture P/N: 350777-1 Matching Pin (14-20 AWG) Manufacture P/N: 350550-1</p>	 <p>6 Pos - Mate-N-Lok Connector Manufacture P/N: 640581-1 Matching Pin (14-20 AWG) Manufacture P/N: 350550-1</p>
 <p>10 Pos - Mini Fit Jr Connector Manufacture P/N: 770580-1 Matching Pin (16-20 AWG) Manufacture P/N: 171639-1</p>	 <p>2 Pos - Mate-N-Lok Connector Manufacture P/N: 350777-1 Matching Pin (14-20 AWG) Manufacture P/N: 350550-1</p>	 <p>8 Pos - Mate-N-Lok Connector Manufacture P/N: 640582-1 Matching Pin (14-20 AWG) Manufacture P/N: 350550-1</p>

Important Contact Information

• If this document has been printed the numbers, emails, and websites may be out of date.

Spyder Controls Corp: info@spydercontrols.com - www.spydercontrols.com - 866-919-9092

Firefly integrations (Mobile App): support@fireflyint.com - www.fireflyint.com - 574-825-4600

Tiffin Service: www.tiffinmotorhomes.com - 256-356-0261

Dometic (Solar Controllers): dometic.com - 1-800-544-4881

Aqua-Hot (Water Heater): www.aquahot.com - 574-247-9235











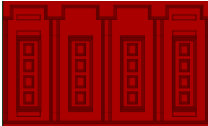

Garnet Industries (SeeLevel Tank Sensors): www.garnetinstruments.com - 1-800-617-7384

Xantrex (Inverter/Charger): www.xantrex.com - 1-800-670-0707

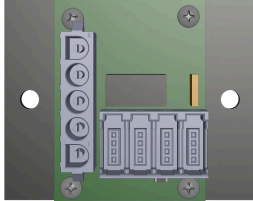
Valid Manufacturing (Glass Dash): validmfg.com - 1-888-632-6477 - **24HR Service** 250-804-1247

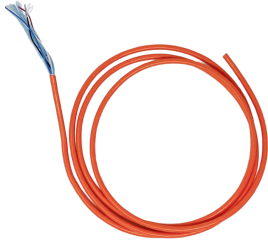
Airxcel (Ventfan / AC Units): Airxcel.com - 574-247-9235

Connectors & Tools

Connectors		
 <p>6 Pos - Mate-N-Lok Connector Manufacture P/N: 1-480704-0</p> <p>Matching Pin (14-20 AWG) Manufacture P/N: 350550-1</p>	 <p>Mini Mate-N-Lok Pin Extractor Manufacture P/N: 189727-1</p>	 <p>G4 Common Drop Tap Spyder P/N: BBCKZK200 Tiffin P/N: 5016592</p>
 <p>9 Pos - Mate-N-Lok Connector Manufacture P/N: 0050841090</p> <p>Matching Pin (14-20 AWG) Manufacture P/N: 350550-1</p>	 <p>Wago Connector Tiffin P/N: 5015508 Manufacture P/N: 231-304/037-000</p>	 <p>G4 Terminator Drop Tap Spyder P/N: BBCKZK400 Tiffin P/N: 5051936</p>
 <p>12 Pos - Mate-N-Lok Connector Manufacture P/N: 1-480708-0</p> <p>Matching Pin (14-20 AWG) Manufacture P/N: 350550-1</p>	 <p>Wago Hook Tool Manufacture P/N: 231-131</p>	 <p>Terminator - HCR-11 Drop Tap Spyder P/N: BMODZGAN6-1 Tiffin P/N: 5131310</p>
 <p>15 Pos - Mate-N-Lok Connector Manufacture P/N: 350736-1</p> <p>Matching Pin (14-20 AWG) Manufacture P/N: 350550-1</p>	 <p>RV-C Cable (By FT) Tiffin P/N: 5064775</p>	 <p>How To Properly Crimp RV-C Network Ends Video</p> <p>Scan with phone camera</p>
 <p>Mat-N-Lok Pin Extractor Manufacture P/N: 305183</p>	 <p>RV-C Cable (20ft W/ MALE ENDS) Spyder P/N: BSPLZL200-20</p>	

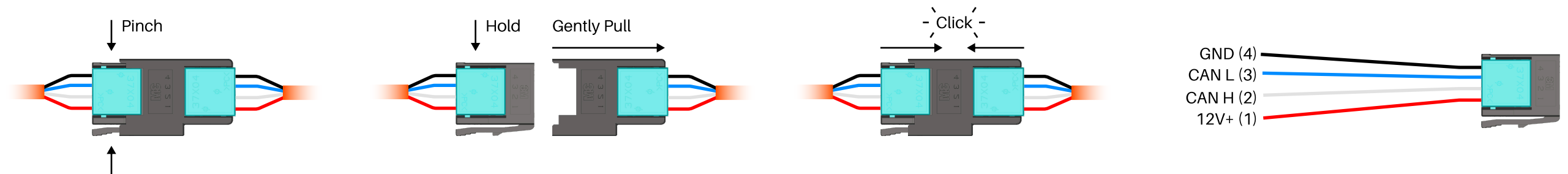

SPYDER
CONTROLS CORP