









Table of Contents

- 1** Module Locations
- 2** G12 Pinout
- 3** G12 Pinout Continued
- 4** Interior Lighting
- 5** Maxxfans
- 6** Screens & Switches
- 7** Slides

- 8** Tank Sensing
- 9** LP Tank Sensing
- 10** Mechanical
- 11** Connectors

Schematic Connections Legend

-  Constant Ground
-  Constant 12V+
-  Switched Ground
-  Switched 12V+
-  Reverse Polarity
-  Signal
-  120V AC Line
-  Network

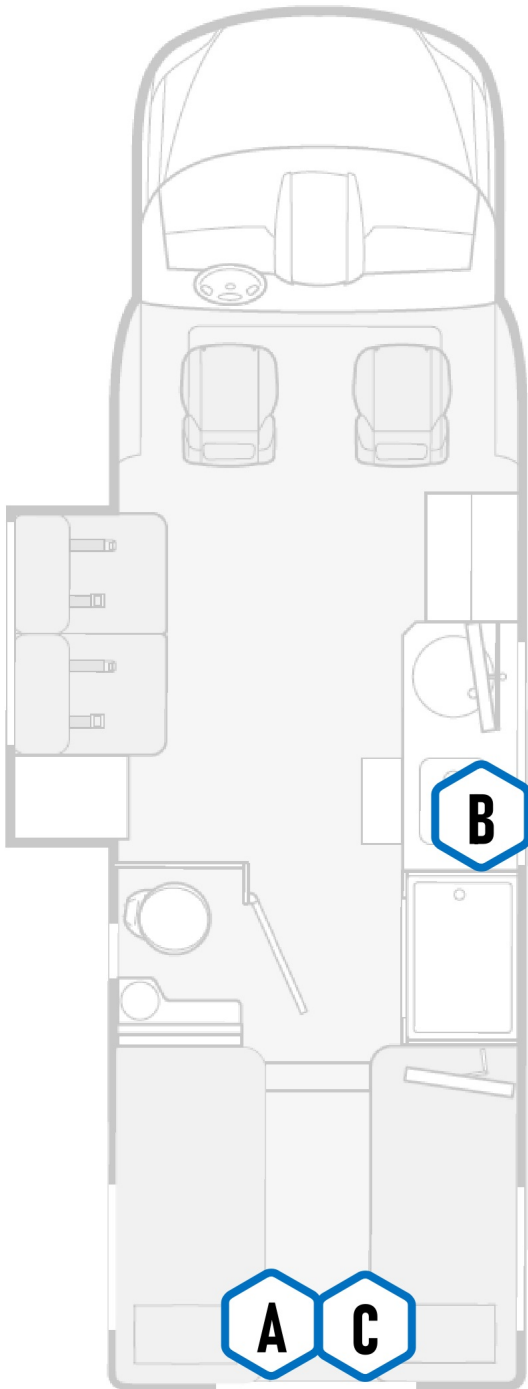

A

G12 Module

Spyder Part Number
BMODZU2VG

Foot Of The Bed

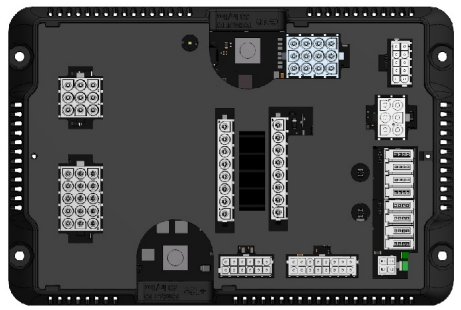

B

7" Lite LCD

Spyder Part Number
BSSPZZQDZ

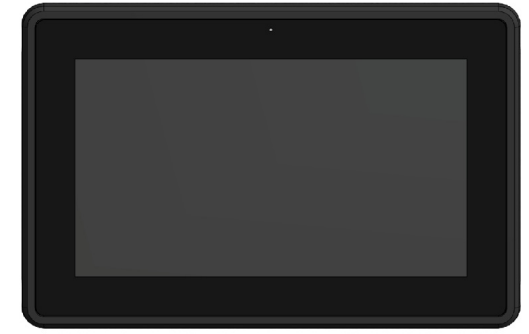

C

Mira Module

Spyder Part Number
BMODZ56VF



J4

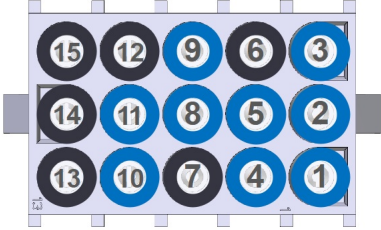

- | | |
|-------------------------|-------------------------|
| ① Hall Lights (CH30) | ⑨ Sofa Slide RET (CH38) |
| ② Entry Light (CH31) | ⑩ Bed Slide EXT (CH39) |
| ③ Porch Light (CH32) | ⑪ Bed Slide RET (CH40) |
| ④ Awning Light (CH33) | ⑫ Spare |
| ⑤ Cargo Light (CH34) | ⑬ Spare |
| ⑥ Spare | ⑭ Spare |
| ⑦ Spare | ⑮ Spare |
| ⑧ Sofa Slide EXT (CH37) | |

J3

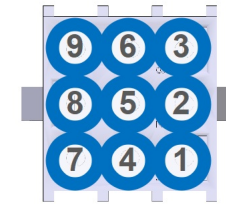

- | | |
|---------------------------|----------------|
| ① Main O/H/Living Room Lt | ⑥ Bathroom Lt |
| ② Sofa Reading Lt | ⑦ Shower Lt |
| ③ Bedroom Lt | ⑧ Front Accent |
| ④ Bed Reading Lt | ⑨ Task Lt |
| ⑤ Bed Slide/ Cabinet Acnt | |

J11

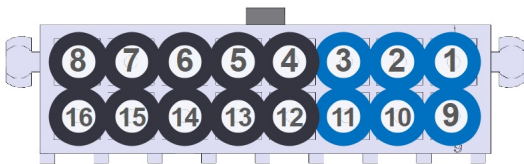

- | | |
|---------------------------|-------------------|
| ① Fresh Tank Sensor Input | ⑨ Tank Sensor GND |
| ② Grey Tank Sensor Input | ⑩ Tank Sensor GND |
| ③ Black Tank Sensor Input | ⑪ Tank Sensor GND |
| ④ Spare | ⑫ Spare |
| ⑤ Spare | ⑬ Spare |
| ⑥ Spare | ⑭ Spare |
| ⑦ Spare | ⑮ Spare |
| ⑧ Spare | ⑯ Spare |

J5

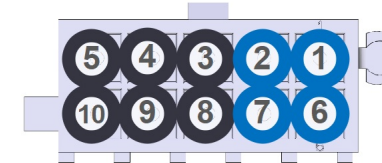

- | | |
|--------------------|------------------------------|
| ① Water Pump (GND) | ⑥ Water Heater Status (+12V) |
| ② Park Brake (GND) | ⑦ Ignition (+12V) |
| ③ Spare (GND) | ⑧ Spare (+12V) |
| ④ Spare (GND) | ⑨ Spare (+12V) |
| ⑤ Spare (GND) | ⑩ Spare (+12V) |

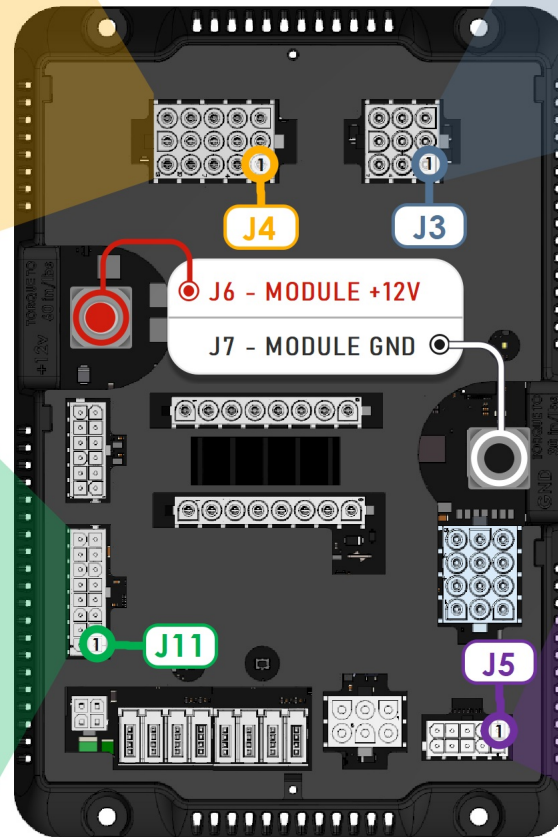

G12 Module
@ Under Bed

J8



1 Water Pump (CH1)	5 Spare
2 Tank Heat 1&2 (CH2)	6 Spare
3 Bed Lift Up (CH3)	7 Spare
4 Bed Lift Down (CH4)	8 Spare

G12 Module @ Under Bed

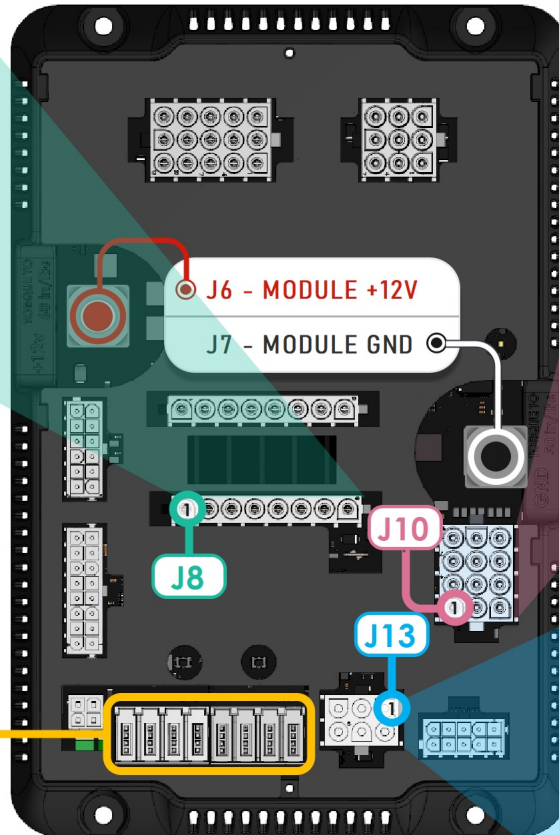

Net Ports

J10

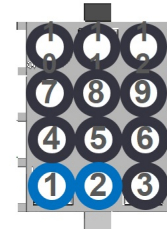

1 Electric Water Heat	7 Spare
2 Gas Water Heat	8 Spare
3 Spare	9 Spare
4 Spare	10 Spare
5 Spare	11 Spare
6 Spare	12 Spare

J13

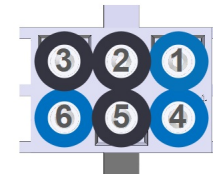

1 LPG Sensor Input	4 LPG Sensor GND
2 Spare	5 Spare
3 Spare	6 Gen Run Input Status

J4

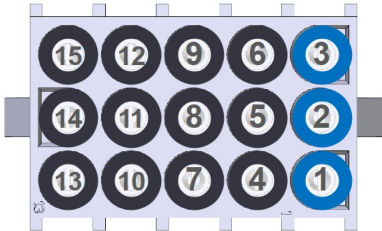

1 Hall Lights (CH30)	9 N/A
2 Entry Light (CH31)	10 N/A
3 Porch Light (CH32)	11 N/A
4 N/A	12 N/A
5 N/A	13 N/A
6 N/A	14 N/A
7 N/A	15 N/A
8 N/A	

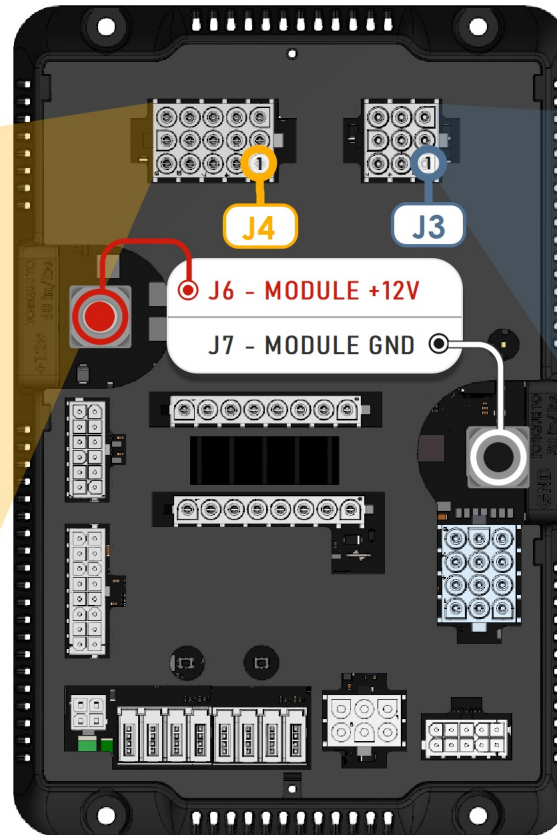

G12 Module

J3

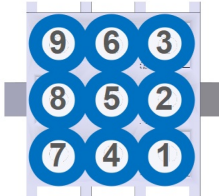

1 Main O/H/Living Room Lt	6 Bathroom Lt
2 Sofa Reading Lt	7 Shower Lt
3 Bedroom Lt	8 Front Accent
4 Bed Reading Lt	9 Task Lt
5 Bed Slide/ Cabinet Acnt	

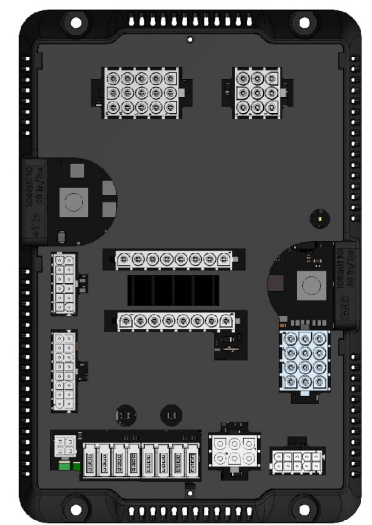
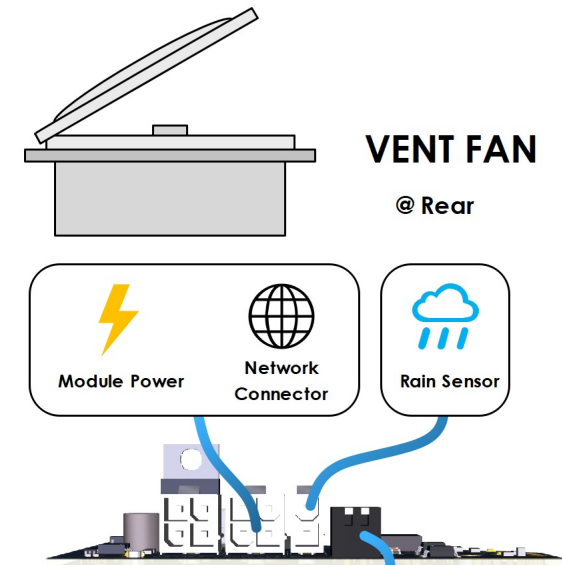
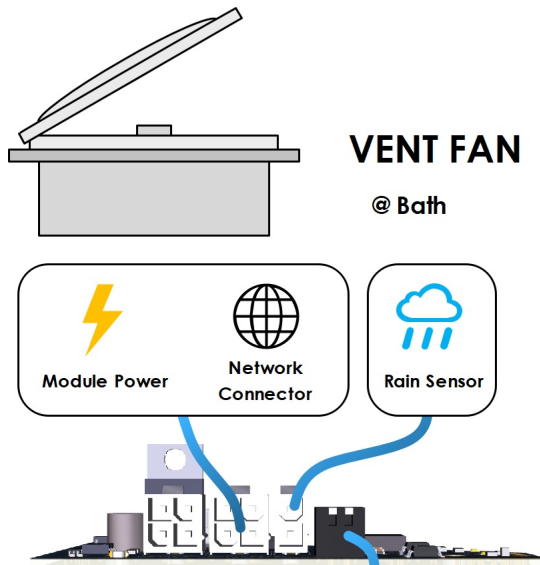
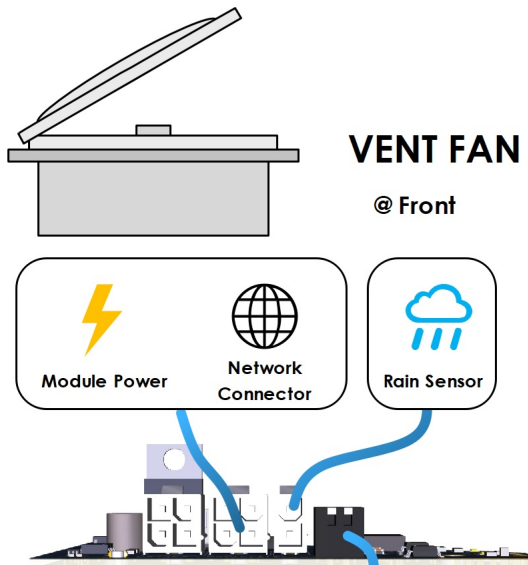

G12 Module

If a switch has the  symbol nearby, it means the switch or module communicates via RF.

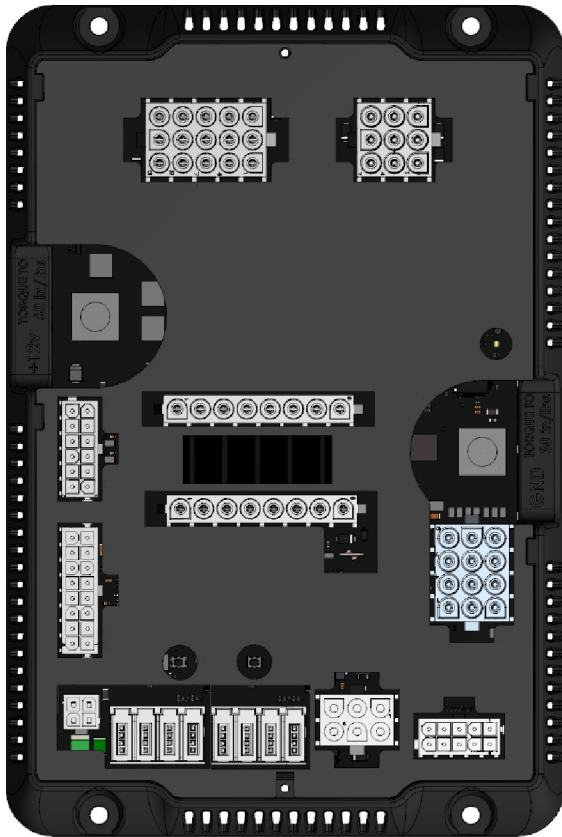

G12 Module
© Under Bed



5" Color LCD
Tiffin P/N: 5127269

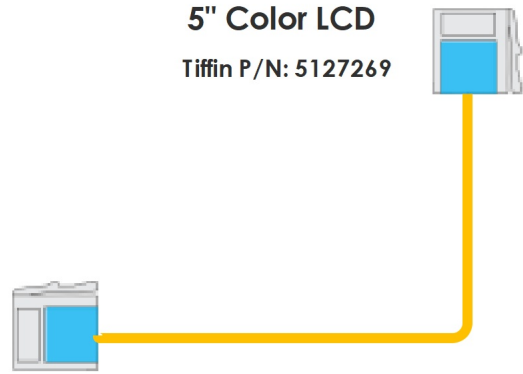

Bedroom Switch Panel



Entry Switch Panel



Bath Switch Panel

i Emergency Override

Park brake and ignition must be on for slides to operate. In case of a system failure, use manual overrides on the G12 to operate slides. Engage overrides using a pen or other pointed object.

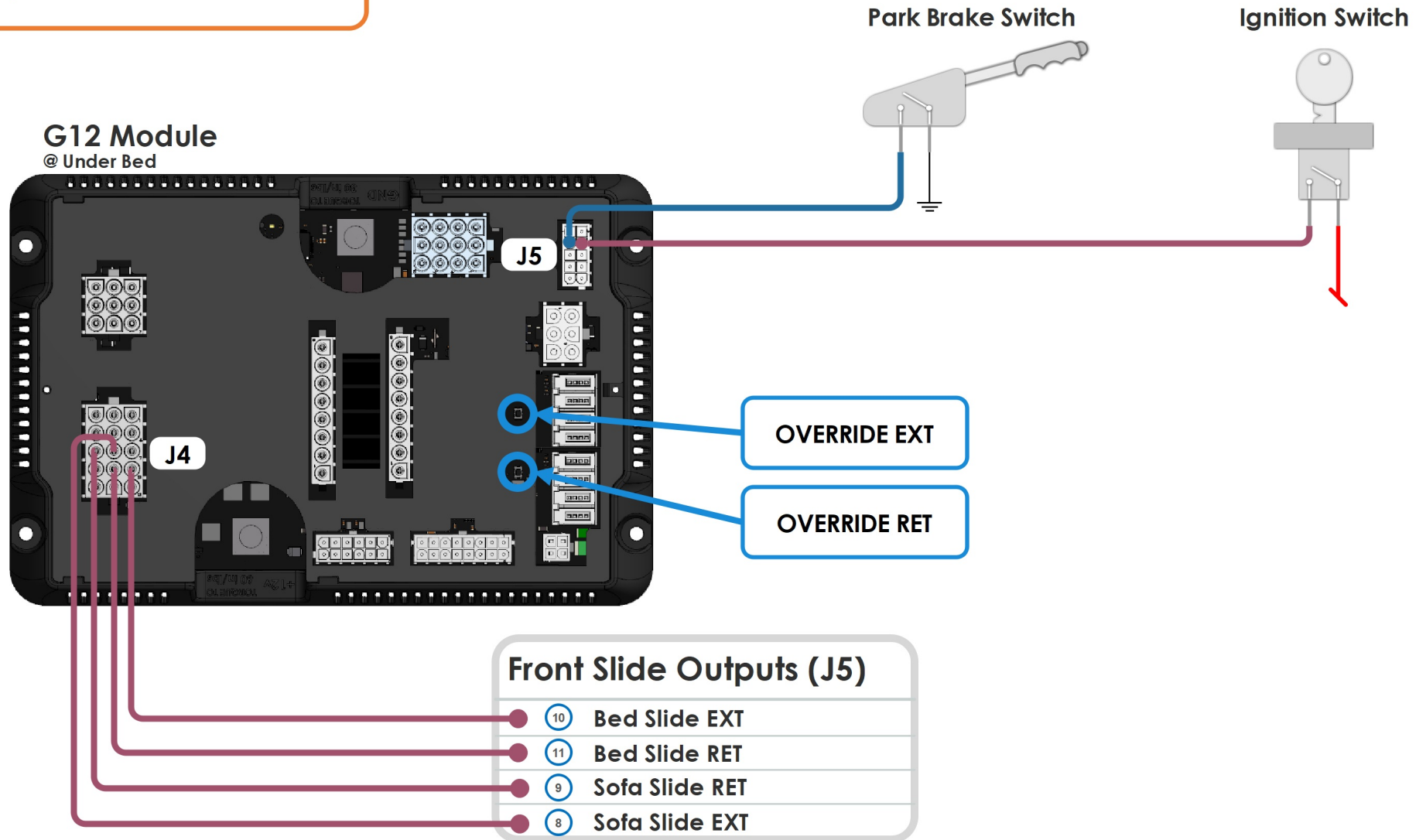

G12 Module

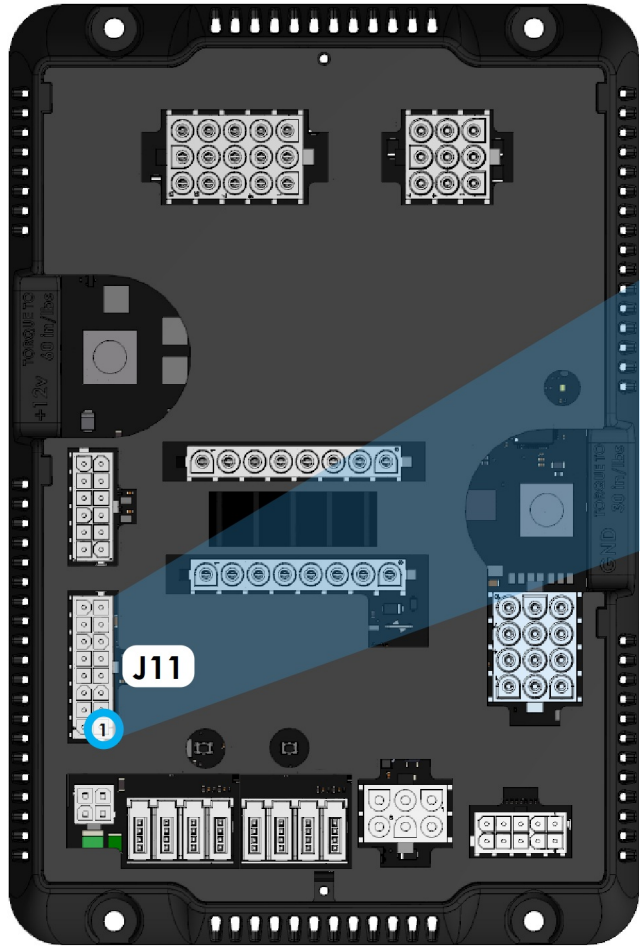

3 Level Tank Sensor System

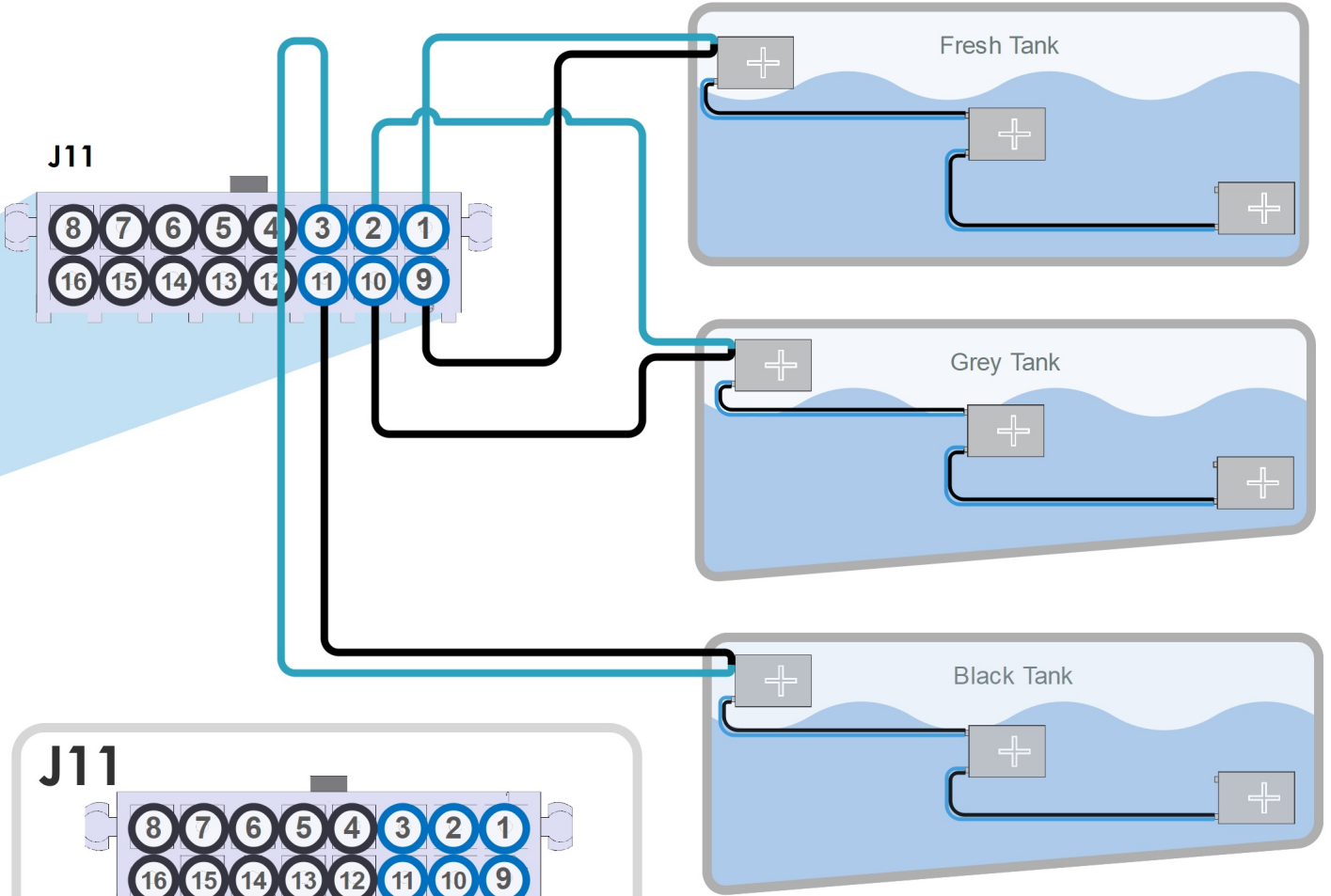

① Fresh Tank Sensor Input	⑨ Tank Sensor GND
② Grey Tank Sensor Input	⑩ Tank Sensor GND
③ Black Tank Sensor Input	⑪ Tank Sensor GND

G12 Module @ Under Bed

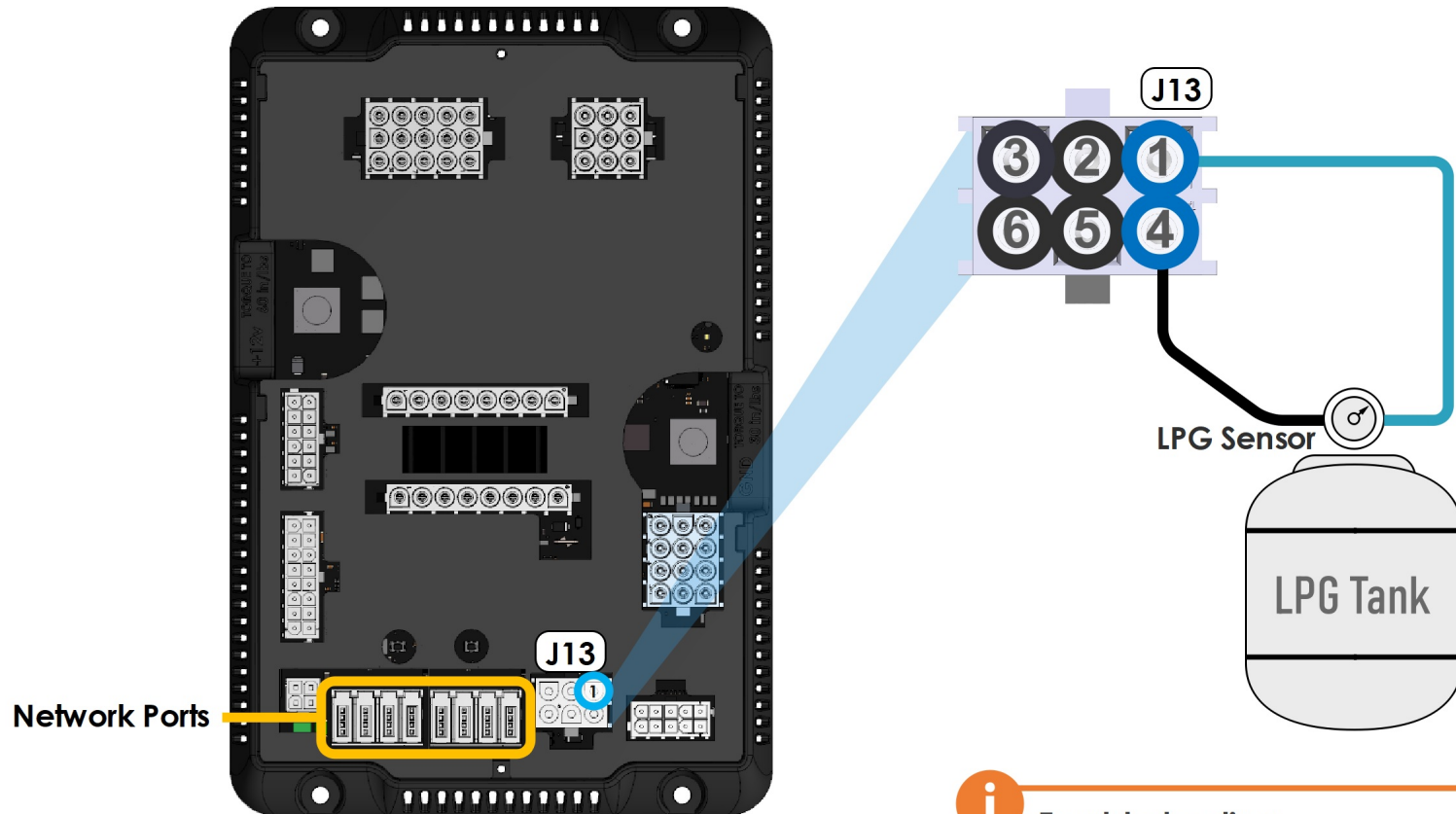

i Troubleshooting

The LP sensor will read full at 90 Ohms and empty at 0 Ohms. If the readings are outside of this range a fault will display on the screen inside the coach.

G12 Module

@ Under Bed

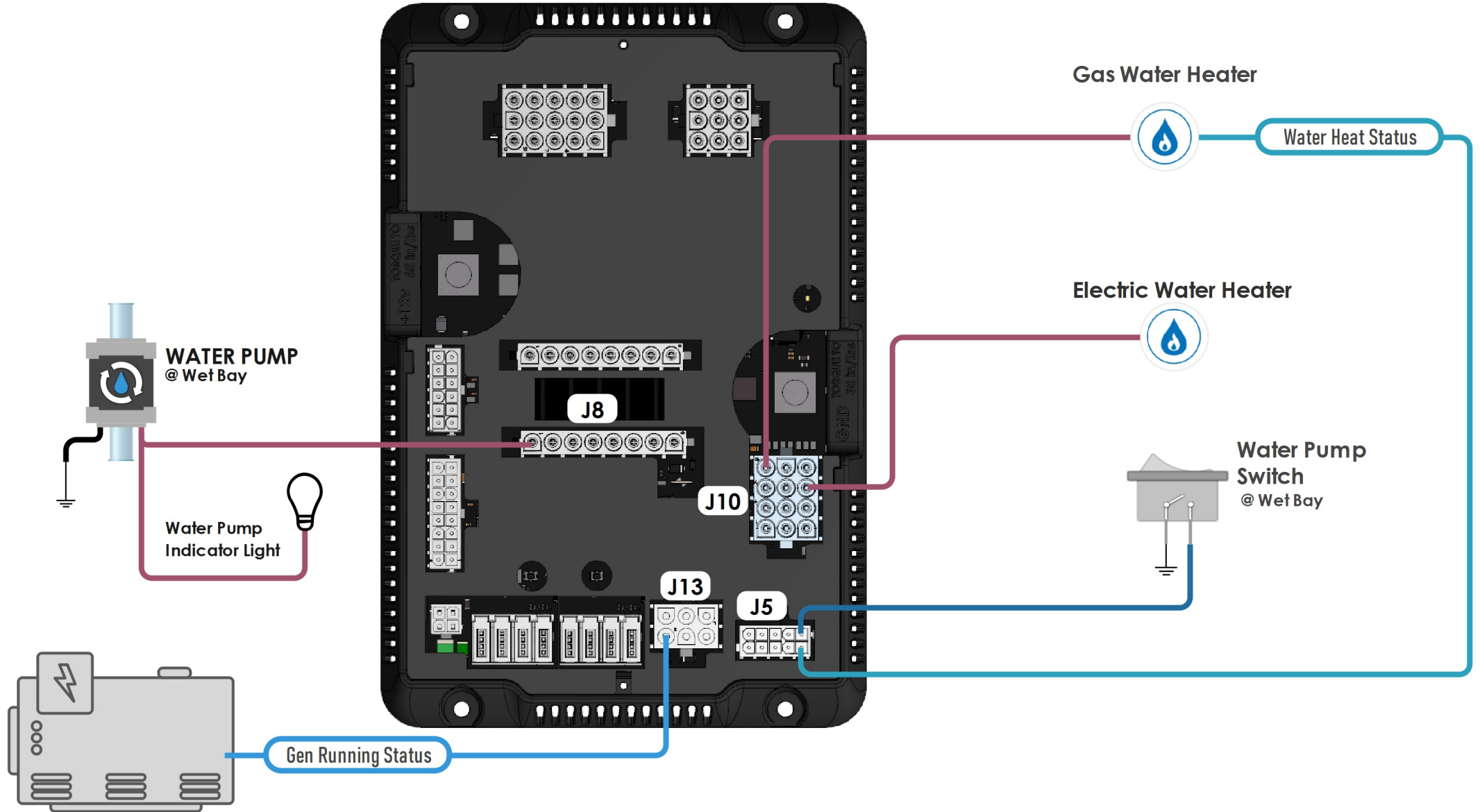

G3 Terminator Tap
Tiffin P/N: 5051935

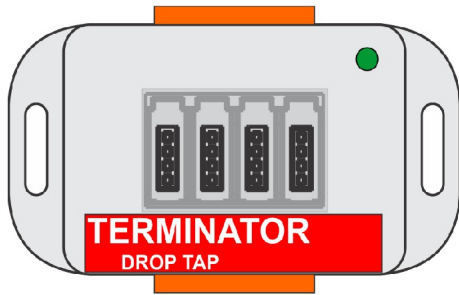

G3 Common Tap
Tiffin P/N: 5027834

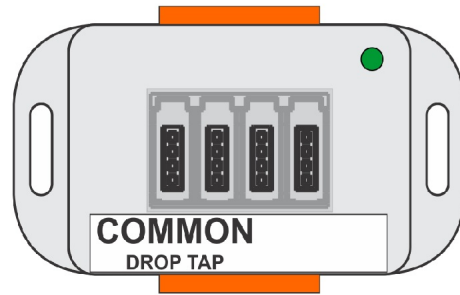

G4 Common Drop Tap
Tiffin P/N: 5016592

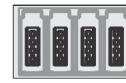

Mini-Clamp Plug
Tiffin P/N: 5066157



G4 Terminator Drop Tap
Tiffin P/N: 5051936



Mini-Clamp Socket
Tiffin P/N: 5066158

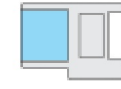

4 Pos Wago Connector
Tiffin P/N: 5015508

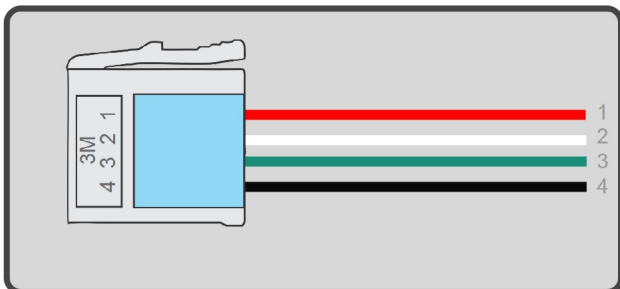
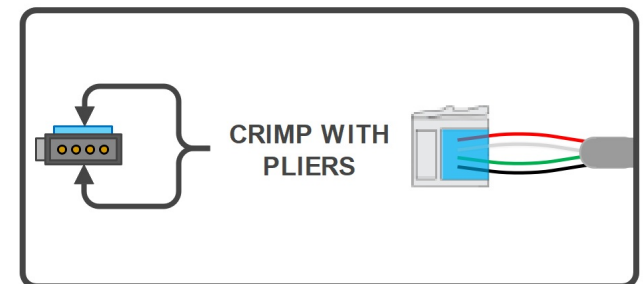
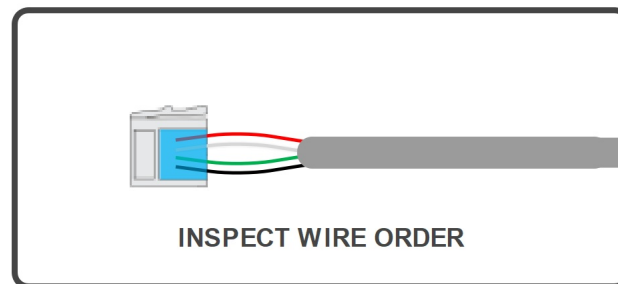
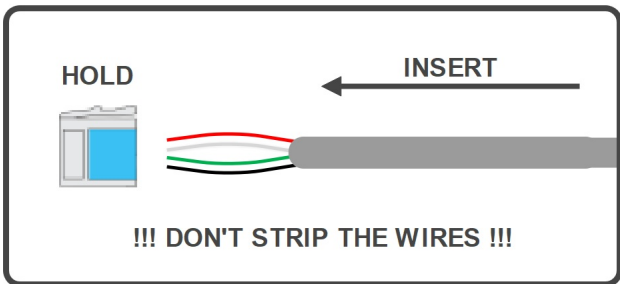
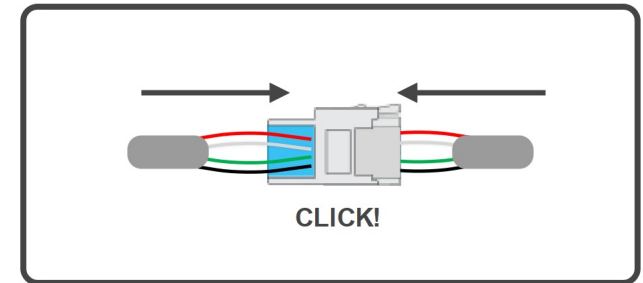
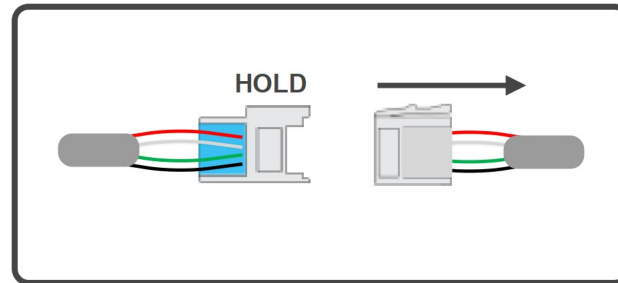
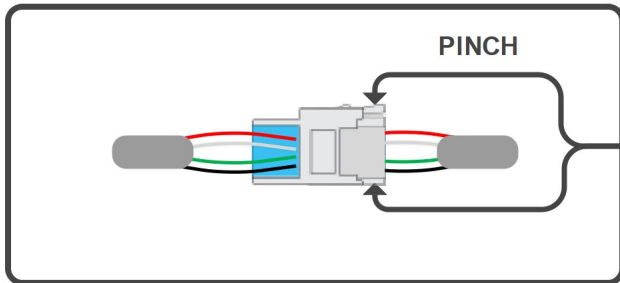
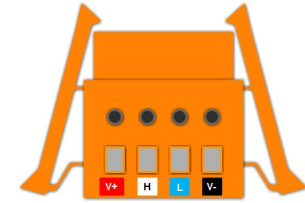

Mate-N-Lok Pin Extractors



Mate-N-Lok Pin Extractor
TE P/N: 305183



Mini Mate-N-Lok Pin Extractor
TE P/N: 189727-1