

# 2024 7" LCD User Guide

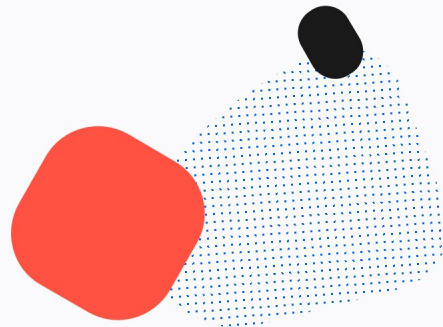

<b>1</b>	Basics	<b>11</b>	Updates
<b>2</b>	Navigation	<b>12</b>	Network
<b>3</b>	Pages	<b>13</b>	Faults
<b>4</b>	Home	<b>14</b>	AGS
<b>5</b>	Power	<b>15</b>	Support
<b>6</b>	Climate		
<b>7</b>	Lights		
<b>8</b>	Slides		
<b>9</b>	Mech		
<b>10</b>	Settings		





## Turning the Screen On

The screen should be on when the house batteries are on.

The screen does go to sleep, tap to wake it up.

If it will not turn on, please contact Spyder - 866-919-9092.

## Interacting With the LCD

The screen in your coach uses capacitive touch technology to interpret your touch.

A firm touch is not necessary for the LCD to interpret your command.

Excessive hard pressing and holding may damage the LCD.

We recommend using a light and gentle touch when running slides and turning lights on and off.

## Status

When a button is pushed on the screen a command is sent over our network.

When the light or load turns on a status is sent back to the screen to indicate that the light or load is on.

Buttons will have a blue ring when they are on and a grey ring when they are off.

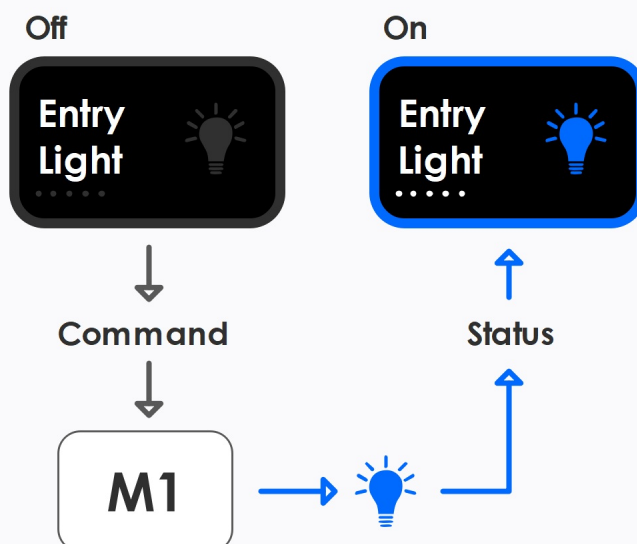



## Settings

To navigate to the screen settings page, press the  icon

## Climate Jumps

A specific climate zone can be accessed by tapping on the zone status on the home page.

For instance, tapping on the Front zone will bring up the climate page already set to the front zone.

This applies to floorheat as well.

Climate can also be accessed by using the bottom navigation bar.

## Drilling In

Any button that has a  icon in the corner can be drilled into.

Drilling in will open additional options or settings for that button.

## Navigating with the bottom bar

The bottom bar allows quick navigation between the various systems of the coach. This bar can be changed from icons to text in the screen settings.



Home

Lights

Power

Climate

Slides

Mech



## Home

The home page is the hub of coach control. Power, climate, tanks, and generator status can be seen on this page.

## Power

The power page shows power flow in the coach from AC to DC and AGS functions can be accessed here as well as solar diagnostics.

## Climate

The climate page displays all three zones of HVAC as well as floor heat settings. Navigate here to adjust the AC units in the coach.

## Lights

All lights controlled by the Spyder System can be found here. Each lighting zone is grouped by location (Main, Bed, Bathroom, ETC)

## Slides

The rear slides can be controlled from this page. The front slides can also be controlled here in an emergency.

## Mech

The mech page is a hub for all mechanical loads. Fans, TV lifts, bed lift, and locks can all be controlled here.

## Settings

The setting popup allows control of screen brightness, theme, time adjustment and more.

## Top Bar

The top bar displays time, current page, and the settings page gear.



## House & Chassis Battery

The house and chassis battery levels are displayed here. If the levels drop to low the image will change color indicating a low battery level.

## Climate Jumps

Climate information is shown for each zone here. Tap on the desired zone to change set temp and HVAC mode.

## Tanks

Tank levels (including LPG) can be viewed here.

## Generator

The generator can be started and stopped from this button.

Tap the  icon to start.

Tap the  icon to stop.

Tap the  icon for more options

## Lights

Quick access to commonly used lights can be found here.

## Solar (Optional)

If the coach is equipped with a GoPower solar controller, it can be controlled from here.

Press the  icon for additional options

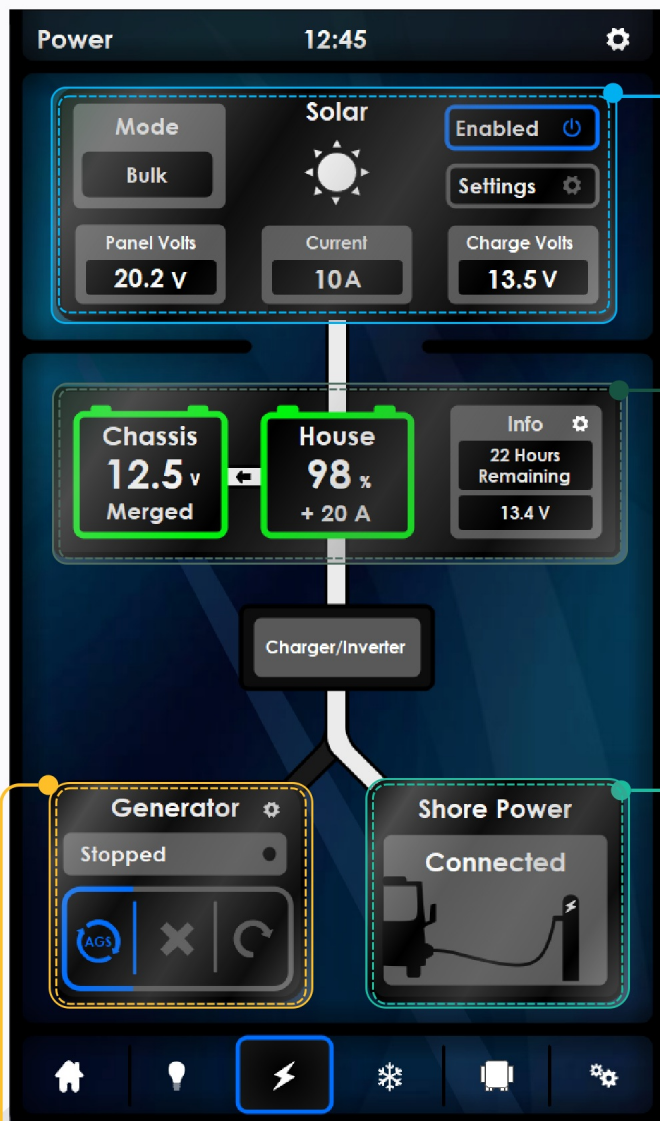

## House & Chassis Battery

The house and chassis battery levels are displayed here. If the levels drop to low the image will change color indicating a low battery level.

Total current entering the battery is displayed.

This is not a direct combination of charger and solar power.

Press the  icon for additional options

## Shore Source

When plugged into shore power the coach image will change indicating you are connected.

This does not display the size of breaker you are connected to.

## Generator

The generator can be started and stopped from this button.

Tap the  icon to start.

Tap the  icon to stop.

Tap the  icon for more options



## Quick Climate

All climate zones are shown in this bar including floor heat zones.

The set temp and ambient temp for each zone is also displayed as well as it's status (cooling, heating, etc).

Press on a desired zone to jump to it.

### Climate Sync - New for 2024

Press this to sync the set temp and operating mode of all zones to the set temp and operating mode of the current zone.

## Climate Dial

To adjust the set temp, slide the white circle around the arc or use the up down arrows.

The set temp is displayed in the middle of the circle.

The current zone is displayed above the set temp.

The HVAC status and fan status are displayed below the set temp.

## HVAC Control Panel

To toggle the A/C, heat pump or furnace press the corresponding button.

The fan A/C fan can be set to high or low. By default, it is set to auto.

## Aqua-Hot

The Aqua-Hot can be toggled to diesel or electric using their respective button on the control panel.

The settings button will bring up additional settings for the Aqua-Hot unit.

## HVAC Safety

The HVAC system has built in safety to ensure the longevity of the A/C units.

The A/C unit will not allow a heat source (furnace, heat pump) to be active while the A/C is cooling.

The A/C units are equipped with freeze sensors. If a freeze sensor is activated the A/C unit will turn off.



## Lighting Sections

The lighting page is separated into three sections.

Each section represents an area in the coach.

## Light Masters

Each lighting section has an individual master.

Pressing this toggle will turn on all the lights in that particular area.

## Dimming Lights

Many lights inside the coach can dim.

A dimming light can be identified by the presence of 5 white dots below the light name.

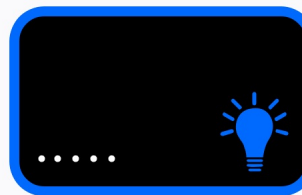

The white dots indicate to what level the light is dimmed.

To dim a light press and hold the light button. A pop up will appear (fig.1).

Use the slider to adjust the brightness of the light.

Use the four quick setting buttons to adjust the lights to a specific level.

Press the icon or icon to confirm the brightness and exit the pop-up.

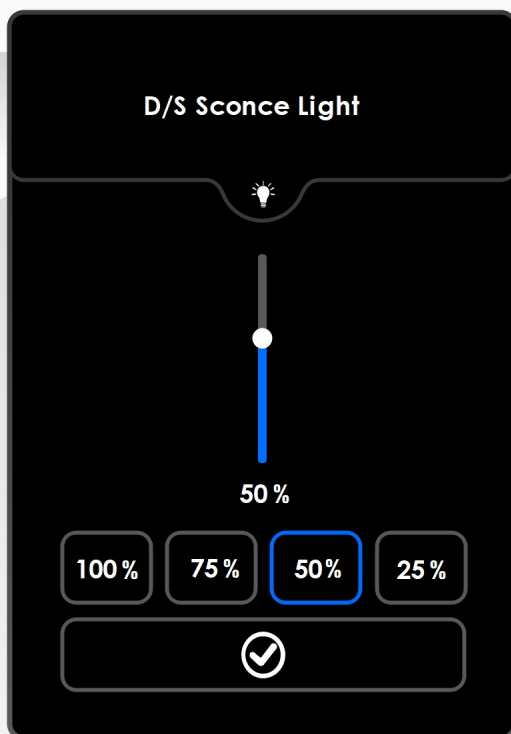

(fig.1)

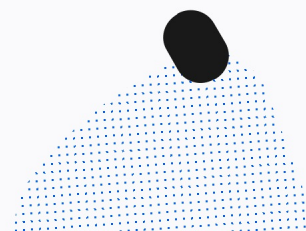

## Slide Operation

To operate the rear slides the ignition must be on and the park brake must be set.

When the ignition and park brake are green a "Slides Ready" checkmark will appear. When this checkmark is present the rear slide can operate.



## Info Center

If there are issues preventing the slide from running a warning will appear in the info center.

## Front Slides

The front slides can be controlled from the slides page in an emergency.

This should only be used if you cannot control the front slides from the rocker switches on the seats.

## Slide Extend/Retract

To extend or retract the slides press the respective buttons.

The buttons do not need to be pressed with any force. A light touch is sufficient to operate the slides.

## Emergency Overrides

Emergency overrides can be found on the M1 Front panel.

These are to be used only when the Spyder System has encountered a network error and the slides cannot be extended or retracted with the controls inside the coach.

Be sure the area is clear, the ignition is on, and the park brake is set before pressing the override.

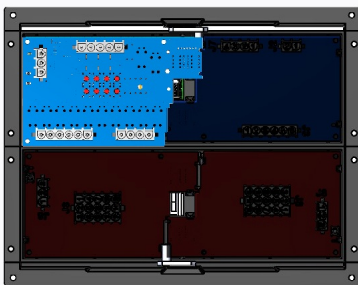

M1 Front Panel

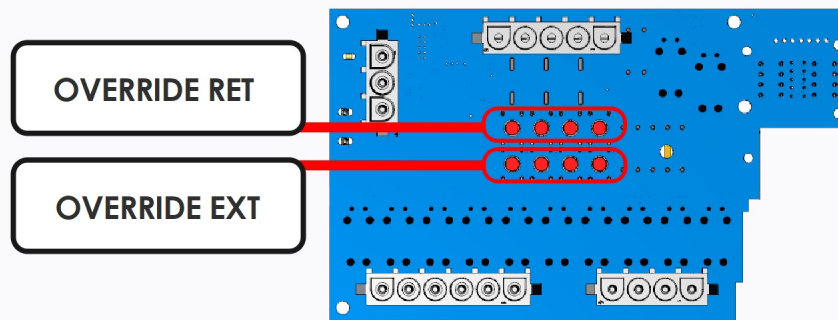

M1 Slide (Card 1)

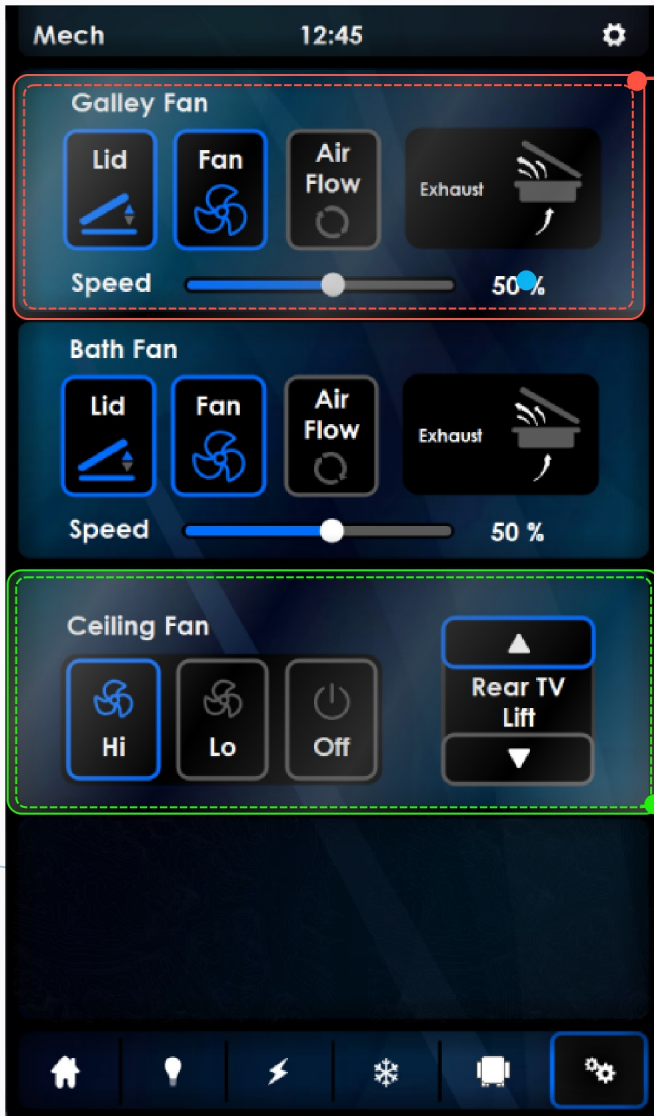

## Vent Fans

Any vent fans installed in the coach can be controlled from here.

Tap the lid button to open or close the fan lid. If you would like a more exact lid position hold the fan lid button and release at the desired height.

If a Maxxfan is installed the airflow direction and speed can be adjusted by using the airflow button and speed slider respectively.

If the vent fans installed are not Maxxfan the only control will be the fan motor and lid open/close.

## Lifts and Ceiling Fan

If any TV lifts are installed in the coach, they will be displayed here.

The bedroom ceiling fan can be controlled from here if it is installed in the coach.

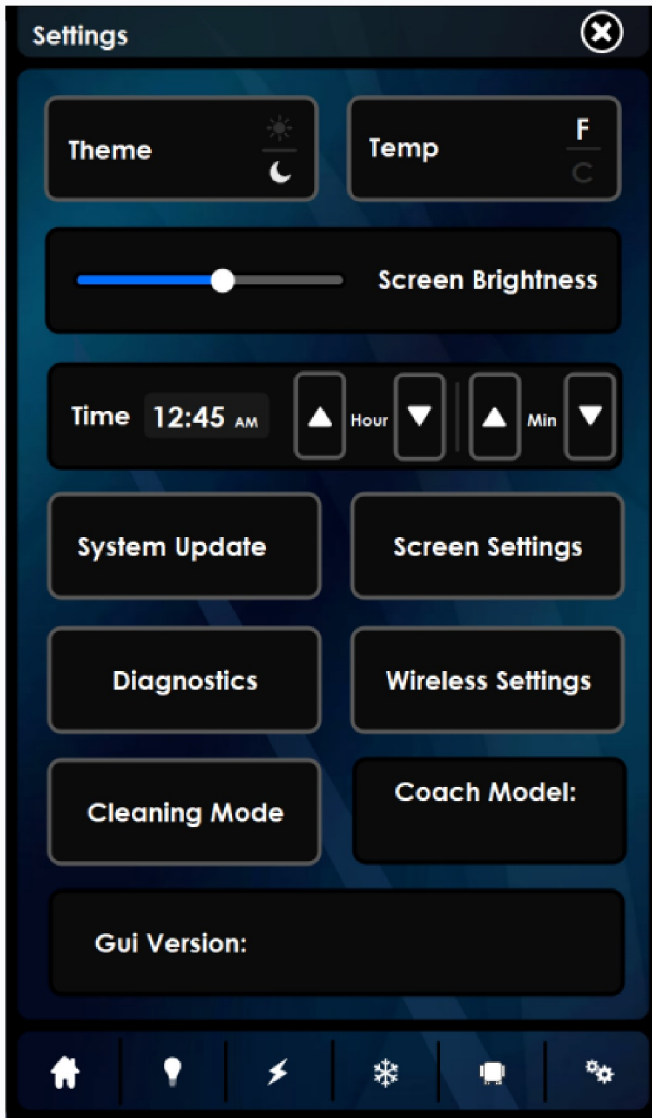

## Cleaning Mode

Press this to clean the LCD without accidentally turning on loads. Be sure to read the cleaning instructions on the screen.

## Temp Units

To adjust the temperature units, tap the button, it will change between C and F.

## Time Adjustment

Use the minute and hour arrows to adjust the system time. This must be set to properly run AGS quiet time.

## Manufacturer Setup

This should only be accessed with assistance from a Spyder Technician. Changing settings in this menu without assistance can cause issues inside the unit.

## Mobile App

To pair the Mira module to your phone tap here and follow the on screen instructions.

This will allow you to control the coach from your mobile device.

## System Update

Pressing this button will open the system update page. This page will check to see if it is up to date.

## Diagnostics

When an issue occurs in your coach Spyder controls may ask you to use the diagnostics system.

This system allows Spyder to see module revisions, load status, and the network updates.

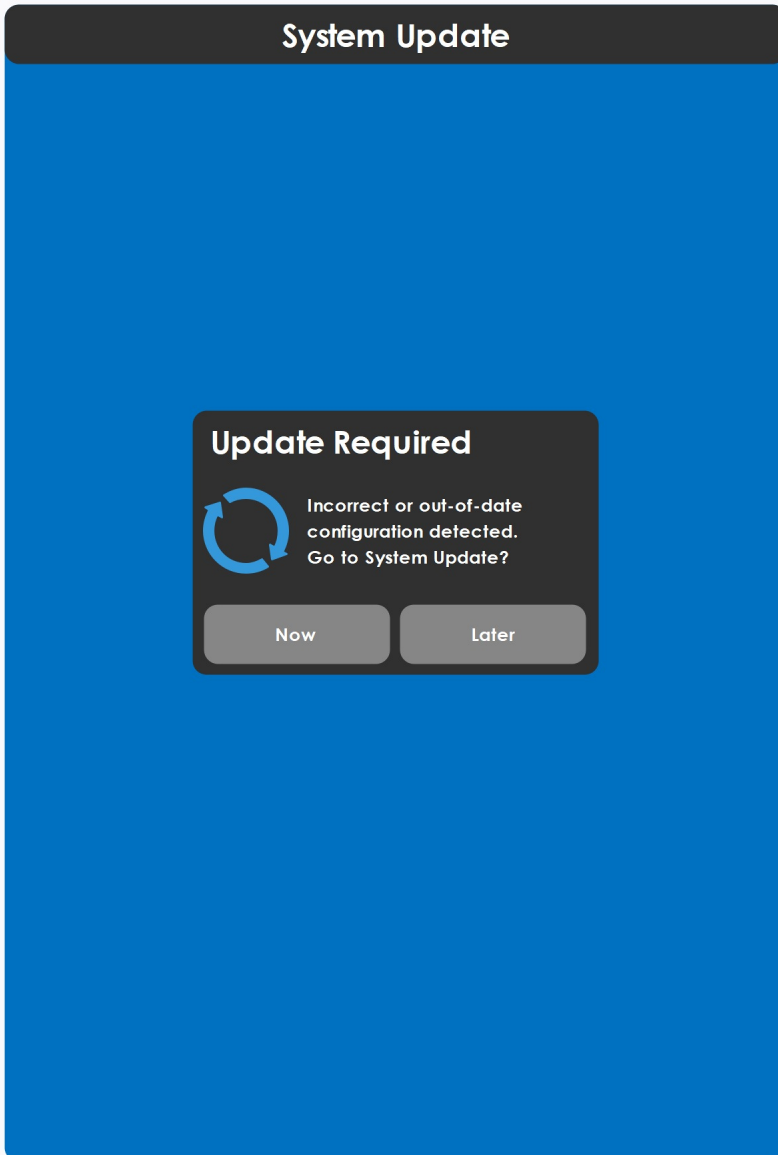

## When Do I Need to Update?

If an update is required a screen (fig.1) will appear. Press "Now" and follow the on-screen prompts to update the system.

Updates are not typically required after a coach is produced.

## What if I Need an Update?

If you have noticed a bug and have contacted Spyder Controls to verify an update is required.

Spyder Controls will send you an email and instructions on how to update your system.

## Module Offline

If a module is offline it is very unlikely the issue is caused by or will be fixed by an update. These issues are primarily related physical network issue.

## Questions

If you suspect you have a bug in the Spyder System and need an update contact 866-919-9092.

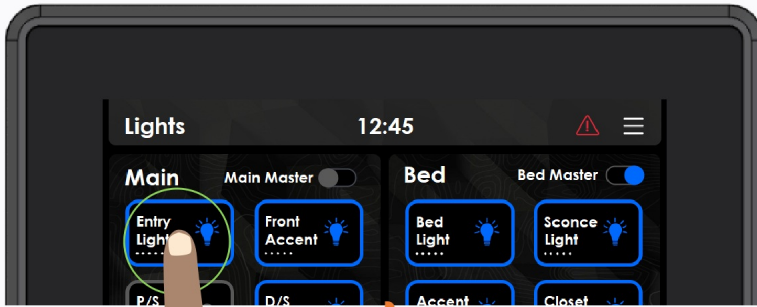

## When a button is pressed

When a button is pressed on the Spyder System the button turns from grey to blue and the load turns on.

## Circular Communication

This diagram shows how this works.

The Spyder network functions like a party line phone system. Every device on the network sees every message that is sent over the network.

When a device sees a message that is addressed to it, the device will act on the message.

This could be turning on a light, running a shade up, or retracting a slide.

Once the device turns on the load it will send a status message back to tell everything on the network that the load is on.

This is what turns the button to blue on the screen.

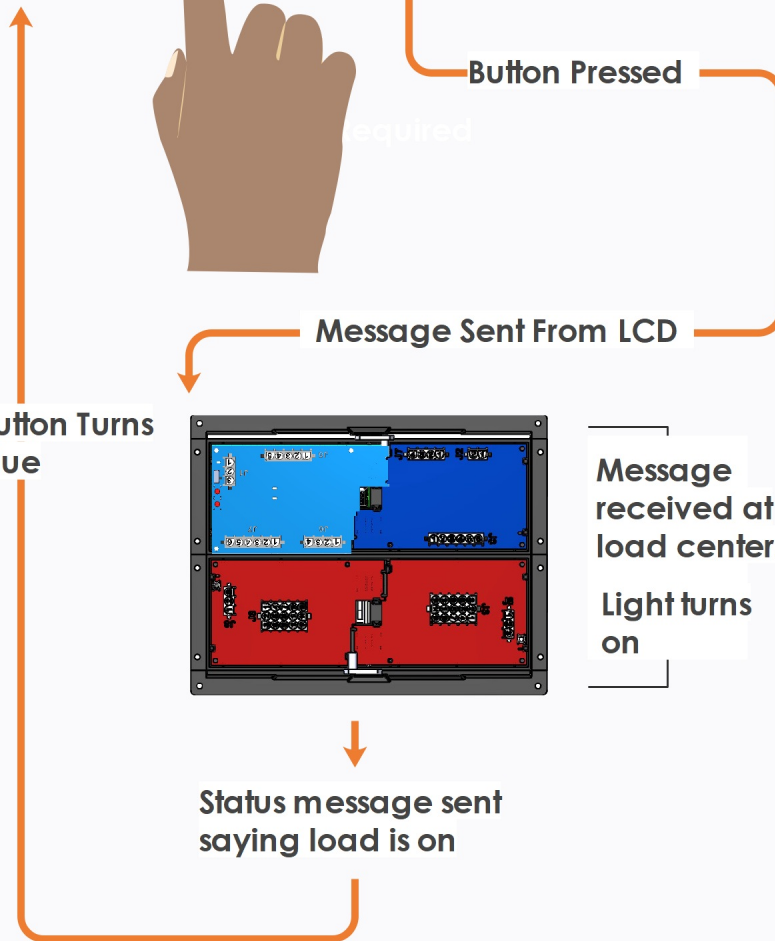

## The Network Cable

The Spyder system sends messages on a network.

Connecting every Spyder screen and control module is a single network cable.

All communication and power for the Spyder system runs over these cables.

## The Red Flashing Triangle



If you see a red flashing triangle press it.

This will direct you to the faults page below.

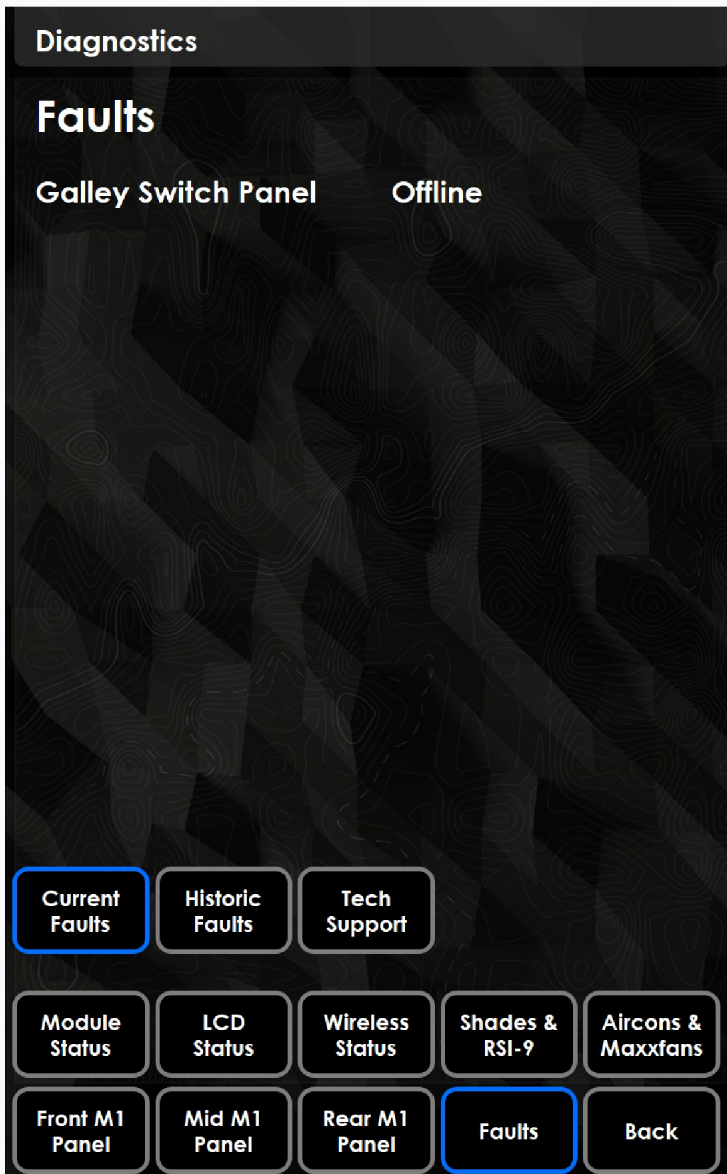

## What is a Fault?

A fault generally means that a module or LCD is no longer communicating on the network.

The module or LCD that is offline will be displayed in plain text.

A fault can also be caused by low voltage or a module light over currenting or shorting.

## What should I do?

For support with the Spyder System call: 866-919-9092 or email: [info@spydercontrols.com](mailto:info@spydercontrols.com)

## Historic Faults

The Spyder System will log faults as network issues can be intermittent.

Historic faults should be reset when you take possession of the coach as many of the faults displayed occurred during manufacturer of the coach.

## Tech Support

If you require tech support or documentation for your coach press tech support and scan the QR code with your camera.

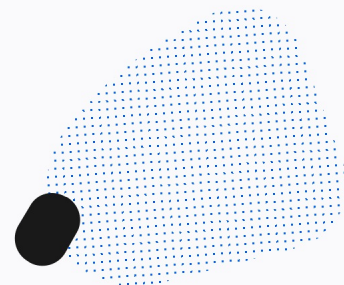

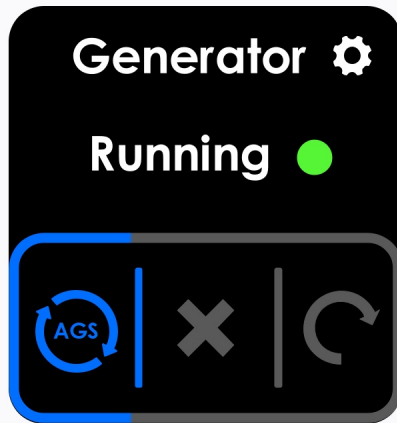

(fig.1)

## How do I Know if AGS is On?

AGS is active and will start the generator if the AGS button is blue as shown in Fig.1

## What Happens After The Maximum Run Time Expires?

Once the maximum run time expires the generator will shut off. AGS will remain active and will assess if the generator needs to be turned on again.

If any start triggers (Low Battery, HVAC Loads, Insufficient Shore Power) are still requesting power the AGS will turn the generator on again.

## Whats is AGS?

The AGS system or Automatic Generator Start will start the generator when certain conditions are met.

## How do I Change AGS Settings?

To adjust when and why your generator starts by itself, locate a generator control button on the main LCD (Fig.1)

Tap the  icon to access more options.

On the next page select "Easy Setup". Follow the on-screen guide to setup AGS.

To quickly adjust AGS parameters press "Manual Setup".

## How do I turn AGS on?

To turn on AGS press the AGS button on either the home page or power page generator section. (Fig.1)

A pop-up should appear, read this and follow the on-screen prompts to enable AGS.

## How do I turn AGS off?

To turn off AGS press the AGS button and ensure it turns grey, this indicates AGS disabled.

AGS can also be disabled by manually stopping or starting the generator from the dash rocker switch.

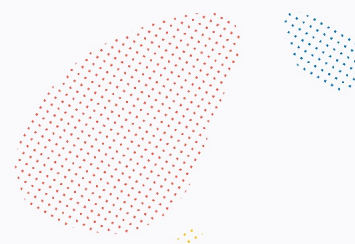

## How do I know if I need support?

If a red flashing triangle appears at the top of the LCD, please call us.

## What number should I call?

Call: 866-919-9092 we almost always have a tech available and it's very rare you will be on hold with us.

You can also email us at [info@spydercontrols.com](mailto:info@spydercontrols.com)

## What time is phone support available?

Phone support is available Monday-Thursday 8:00AM-5:00PM MTN and Friday 8:00AM-12:00PM MTN.

An emergency line is available for weekends and holidays.

## Where can I find additional documentation?

Visit [Spydercontrols.com](http://Spydercontrols.com) and login using the following credentials.

Username: Tiffin  
Password: Motorhomes