











Multiplex Integration Schematic

2021 RED 340

Schematic Connections Legend	
 Constant Ground	 Reverse Polarity
 Constant 12V+	 Signal
 Switched Ground	 120 VAC Line
 Switched 12V+	 Network Cable

2021 Tiffin Allegro RED 340 General Component Locations Diagram

(Components not to scale)

Galley
Tiffin P/N:
5103634



5" Color Screen
Tiffin PN: 5104414



G6 CHASSIS PANEL @ Front
Electrical Compartment
Tiffin PN: 5083668

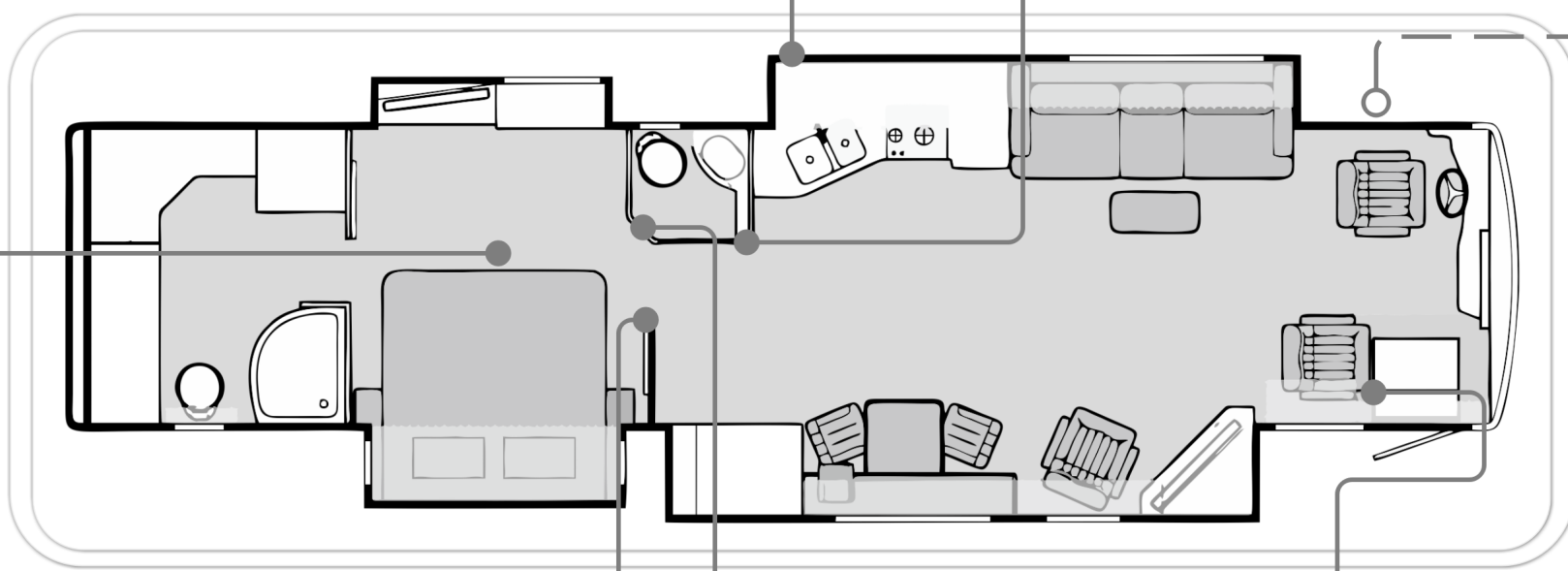
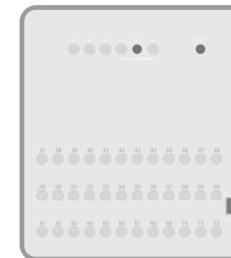

Bedroom
Tiffin P/N:
5093649

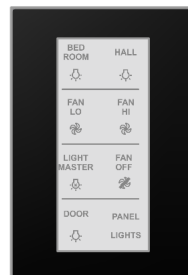

Mid Bath
Tiffin P/N:
5093651

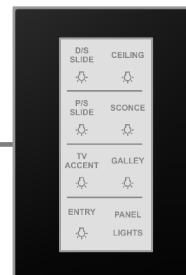

Entry
Tiffin P/N:
5093650

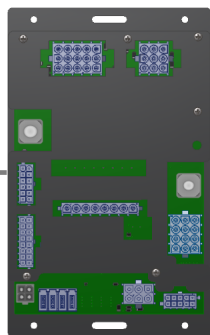

G12 Panel
@ Foot of Bed
Tiffin P/N: 5104413

Module located on exterior or under coach bay

Module located inside the coach

2021 Tiffin Allegro RED 340

G12 Pinout

(Components not to scale)

J4

- 1 CH 30 - Main Ceiling Lts
- 2 CH 31 - Galley Lts
- 3 CH 32 - Bed Ceiling Lts
- 4 CH 33 - Galley Accent Lts
- 5 CH 34 - Door Lt
- 6 CH 35 - Entry Lt
- 7 CH 36 - Porch Lt
- 8 CH 37 - Bath Lts
- 9 CH 38 - Task Lts
- 10 CH 39 - D/S Slide Lt
- 11 CH 40 - Elect. WTR HTR (Opt.)
- 12 CH 41 - Truma WTR HT Const.
- 13 CH 42 - Spare
- 14 CH 43 - Diesel/Gas WTR HTR (Opt.)
- 15 CH 45 - P/S Slide LT

J11

- 1 Tank 1 Sig. Fresh
- 2 Tank 2 Sig. Grey
- 3 Tank 3 Sig. Black
- 4 Spare
- 5 Spare
- 6 Spare
- 7 Spare
- 8 Spare
- 9 Tank 1 Sig. Fresh
- 10 Tank 2 Sig. Grey
- 11 Tank 3 Sig. Black
- 12 Spare
- 13 Spare
- 14 Spare
- 15 Spare
- 16 Spare

J5

- 1 Park Brake - GND
- 2 WTR Pump SW - GND
- 3 Spare
- 4 Spare
- 5 Spare
- 6 FR P/S Slide EXT (12V+)
- 7 FR P/S Slide RET (12V+)
- 8 FR D/S Slide EXT (12V+)
- 9 FR D/S Slide RET (12V+)
- 10 Ignition (12V+)

J13

- 1 LPG 1 Sig.
- 2 LPG 1 GND
- 3 Spare
- 4 Spare
- 5 CHS +12V Input
- 6 WTR HTR Status +12V Opt.

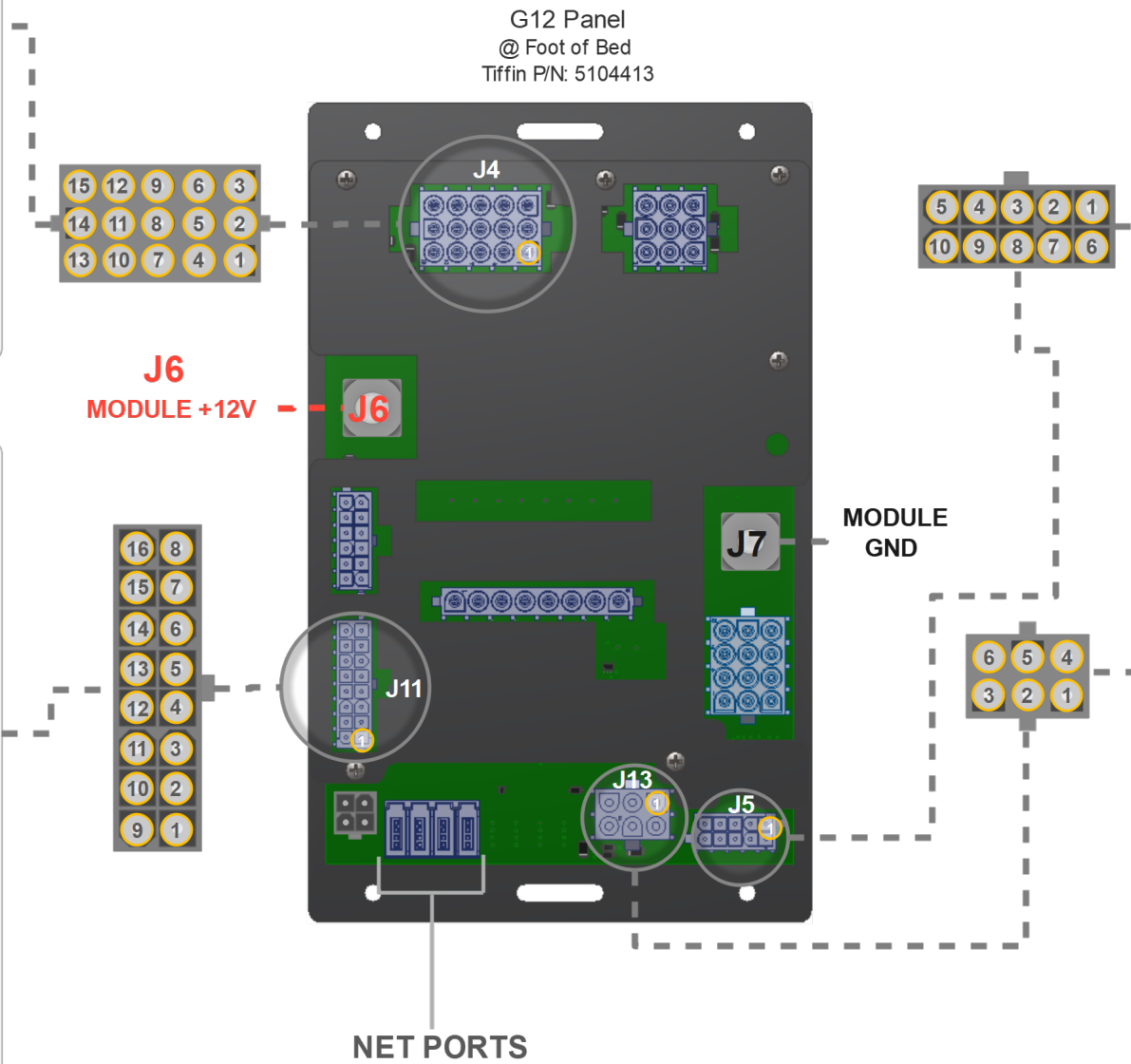

G12 Panel
@ Foot of Bed
Tiffin P/N: 5104413

J6
MODULE +12V

MODULE GND

NET PORTS

2021 Tiffin Allegro RED 340 Slide System

(Components not to scale)

P/S and D/S slide module power wires may be swapped.

Park Brake Switch

Ignition Switch

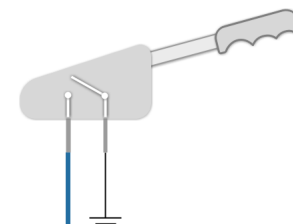

- Power Input
- D/S Front Slide Retract
- D/S Front Slide Extend
- P/S Front Slide Retract
- P/S Front Slide Extend

If one of the front slides is electric, the corresponding Hydraulic Pump wire should not be connected.

- P/S Rear Slide Controller
- Extend Input
 - Retract Input
 - Power Input

- D/S Rear Slide Controller
- Extend Input
 - Retract Input
 - Power Input

Park brake and ignition must be on for slides to operate.
In case of a system failure, use manual overrides on front of G6 Chassis panel to operate slides. Engage overrides using a pen or other pointed object.

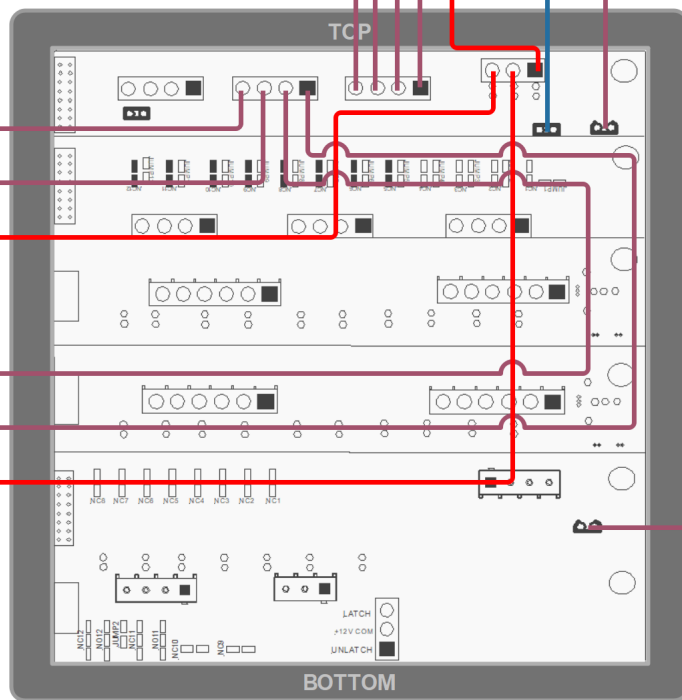

G6 Chassis Panel
@ Rear Closet
Tiffin P/N: 5083668

G12 Panel
@ Foot of Bed
Tiffin P/N: 5104413

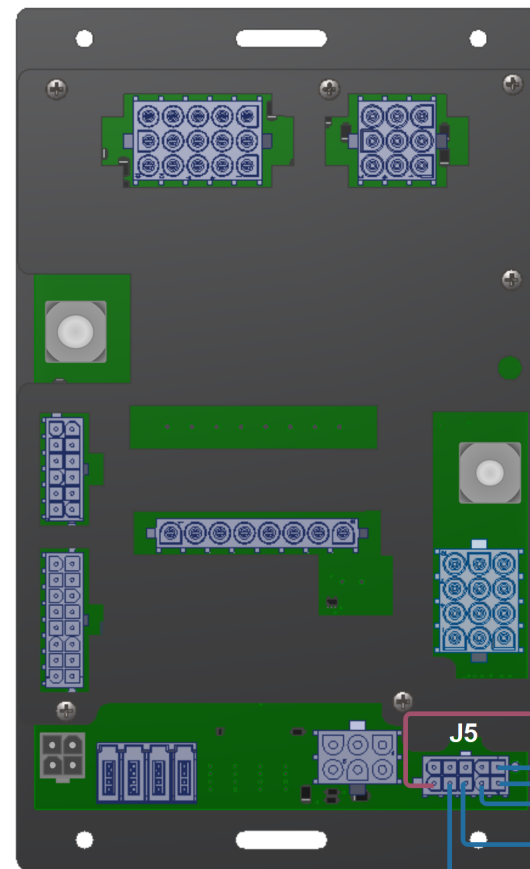

P/S Front Slide Switch

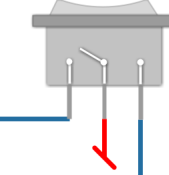

D/S Front Slide Switch

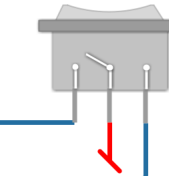

2021 Tiffin Allegro RED 340 Lighting System

(Components not to scale)

All lights listed do NOT dim

- J4**
- ① CH 30 - Main Ceiling Lts
 - ② CH 31 - Galley Lts
 - ③ CH 32 - Bed Ceiling Lts
 - ④ CH 33 - Galley Accent Lts
 - ⑤ CH 34 - Door Lt
 - ⑥ CH 35 - Entry Lt
 - ⑦ CH 36 - Porch Lt
 - ⑧ CH 37 - Bath Lts
 - ⑨ CH 38 - Task Lts
 - ⑩ CH 31 - D/S Slide Lights
 - ⑮ CH 31 - P/S Slide Lights

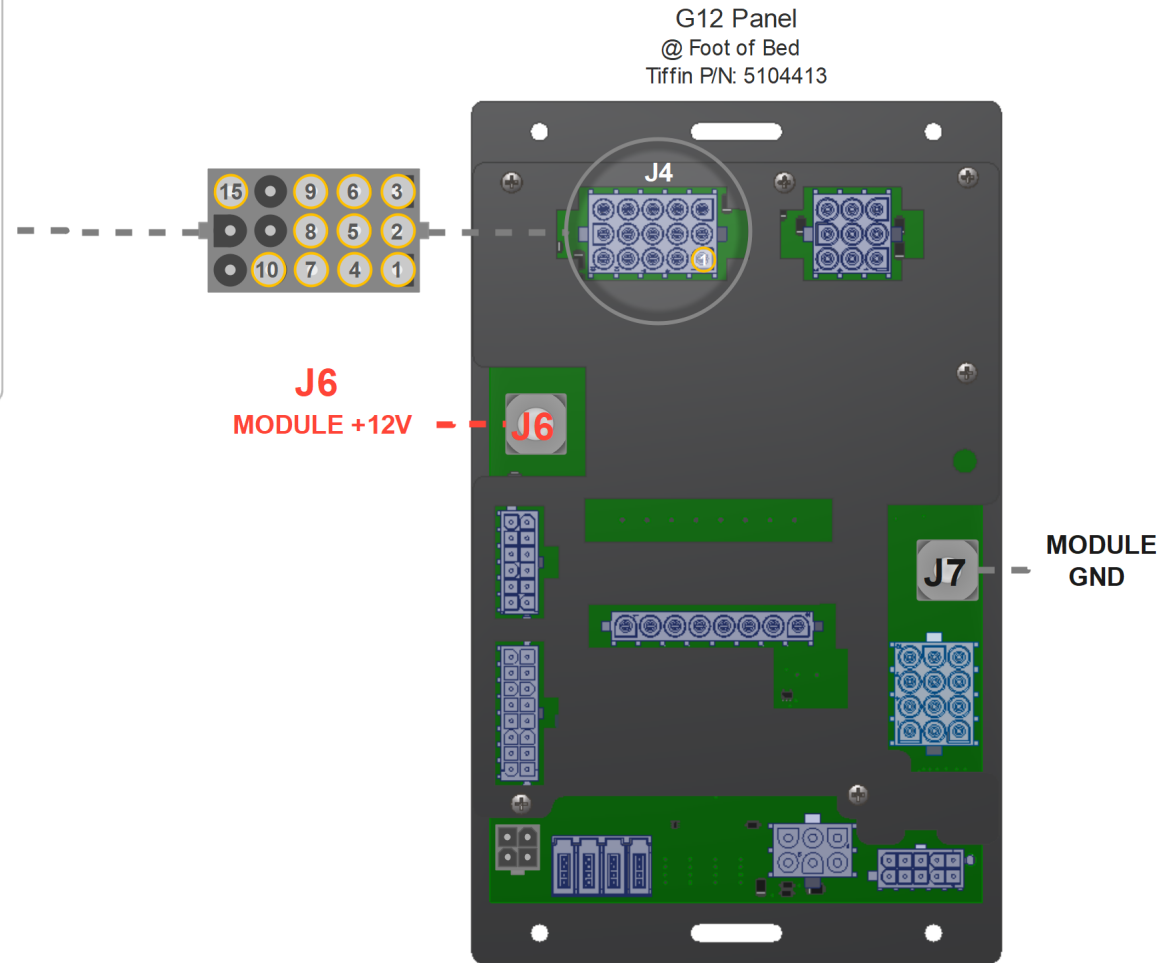

2021 Tiffin Allegro RED 340 Vent Fan & Ceiling Fan System (Components not to scale)

Vent Fan
@ Rear Bath
***Only on RED 38LL
Floorplan***

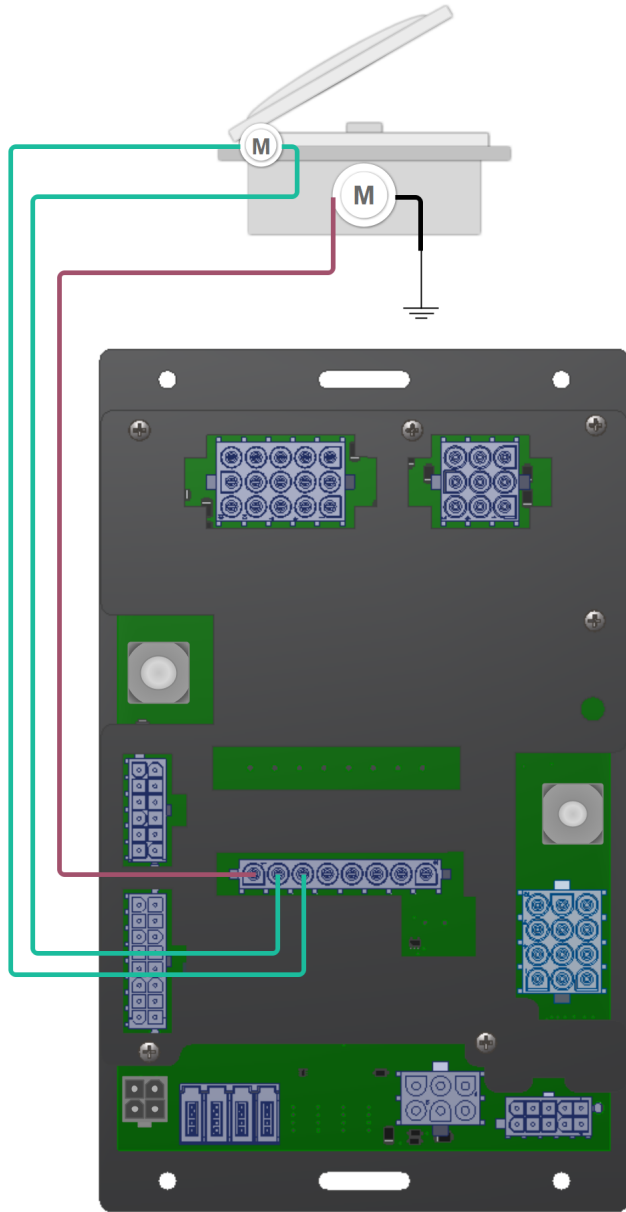

G12 Panel
@ Foot of Bed
Tiffin P/N: 5104413

Vent Fan
@ Bath

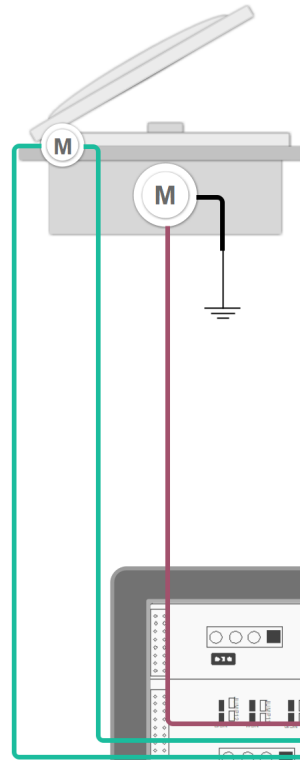

Vent Fan
@ Galley

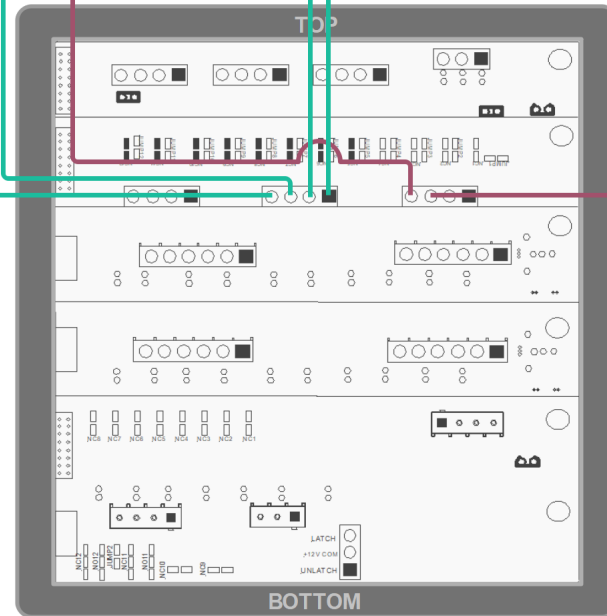
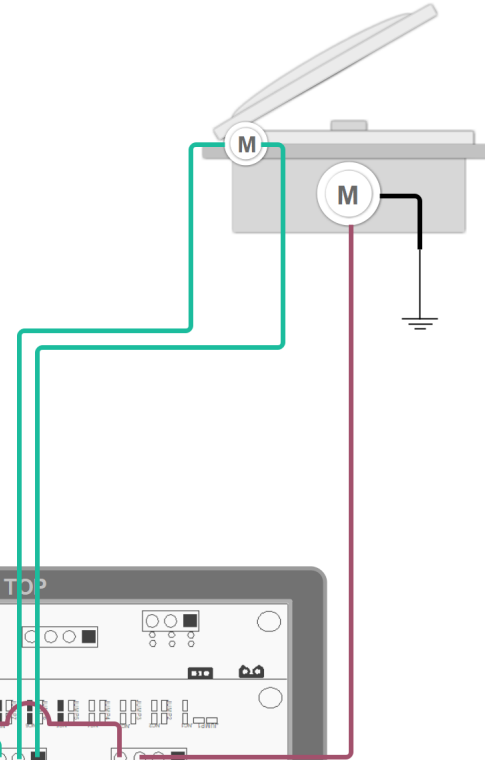

G6 Chassis Panel
@ Rear Closet
Tiffin P/N: 5083668

2021 Tiffin Allegro RED 340 Tank Level System (Components not to scale)

G12 Panel
@ Foot of Bed
Tiffin P/N: 5104413

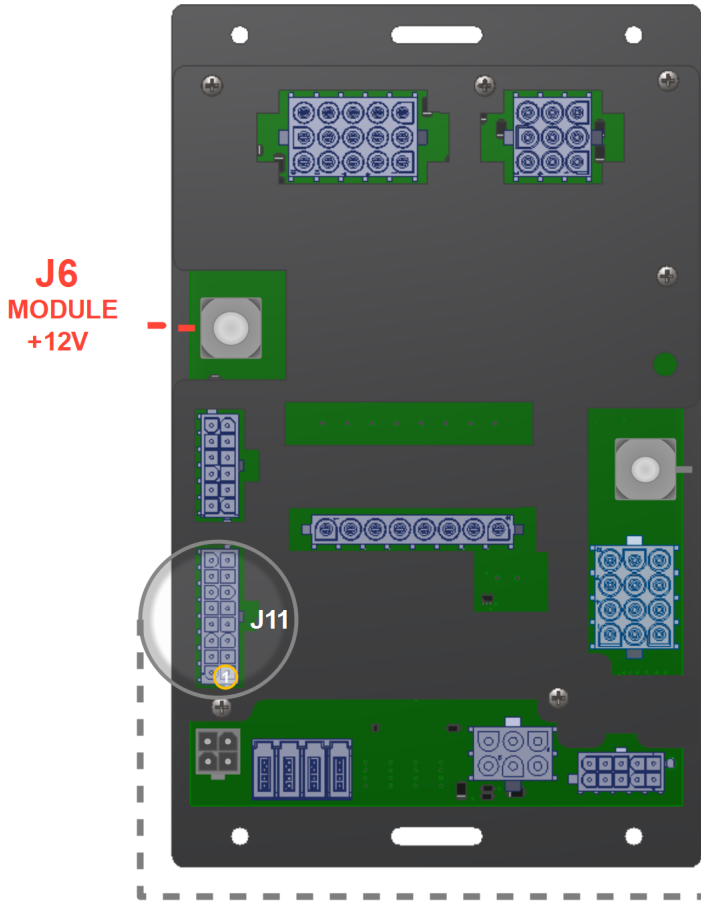

Probe Tank Sensor System

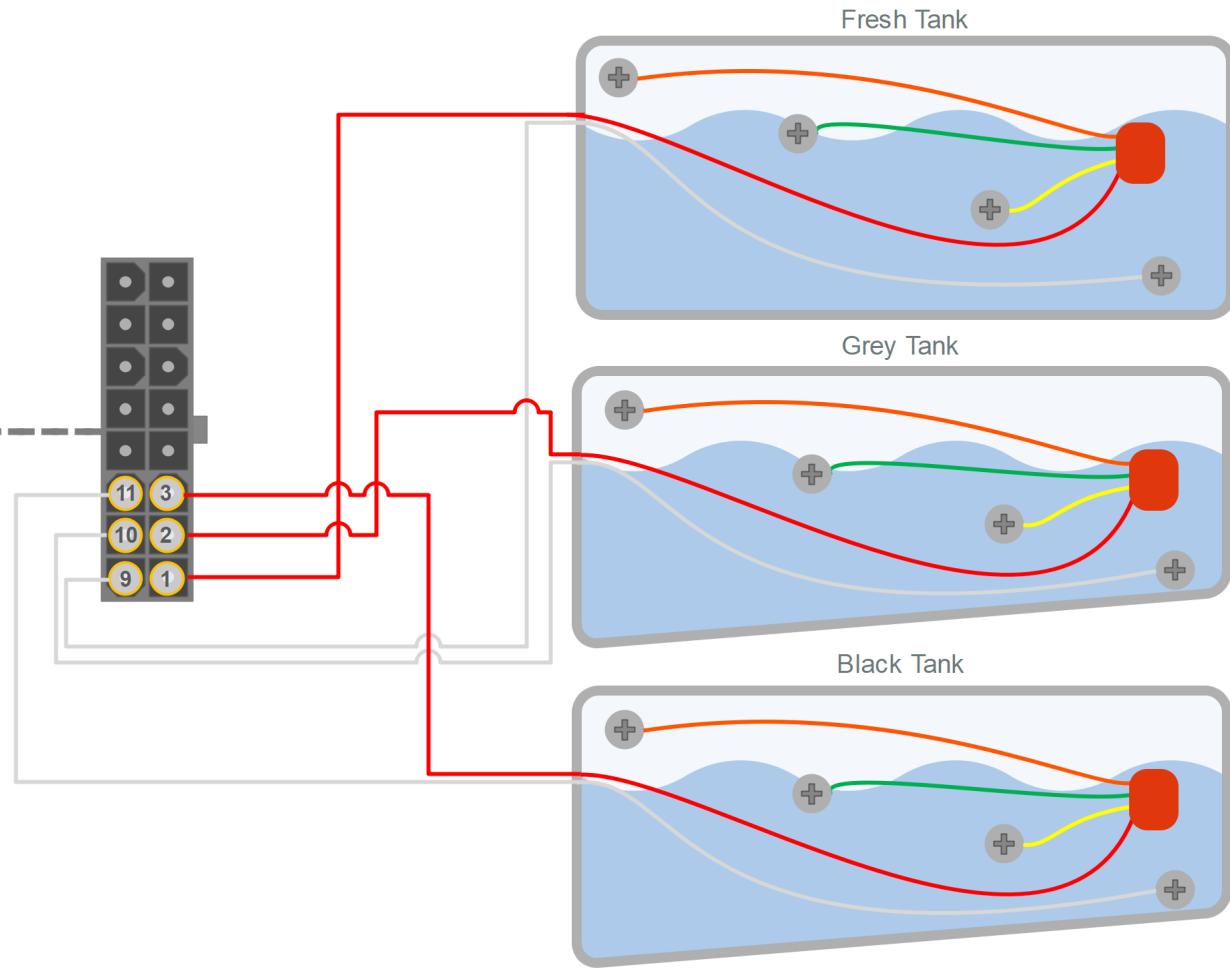

J11

- | | |
|---------------------|---------------------|
| 1 Tank 1 Sig. Fresh | 9 Tank 1 GND Fresh |
| 2 Tank 2 Sig. Grey | 10 Tank 2 GND Grey |
| 3 Tank 3 Sig. Black | 11 Tank 3 GND Black |
| 4 Spare | 12 Spare |
| 5 Spare | 13 Spare |
| 6 Spare | 14 Spare |
| 7 Spare | 15 Spare |
| 8 Spare | 16 Spare |

2021 Tiffin Allegro RED 340 Switch and Screen Network (Components not to scale)

G12 Panel
@ Foot of Bed
Tiffin P/N: 5104413

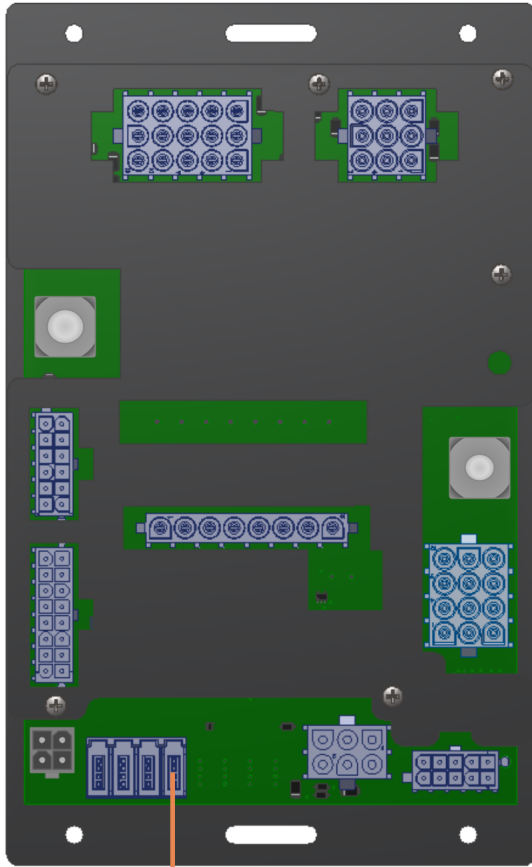

5" Color Screen
Tiffin PN: 5104414



Bedroom
Tiffin P/N:
5093649

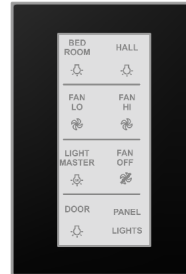

Mid Bath
Tiffin P/N:
5093651

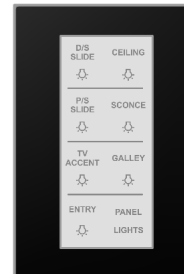

Entry
Tiffin P/N:
5093650

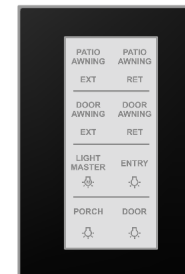

Galley
Tiffin P/N:
5103634



If a switch or module has the symbol above near it, it means that switch or module communicates via RF.

2021 Tiffin Allegro RED 340 Miscellaneous (Components not to scale)

Park Brake Switch

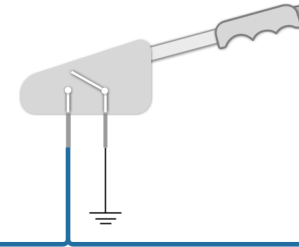

Ignition Switch

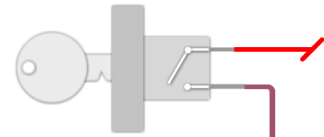

G6 Chassis Panel
@ Rear Closet
Tiffin P/N: 5103560

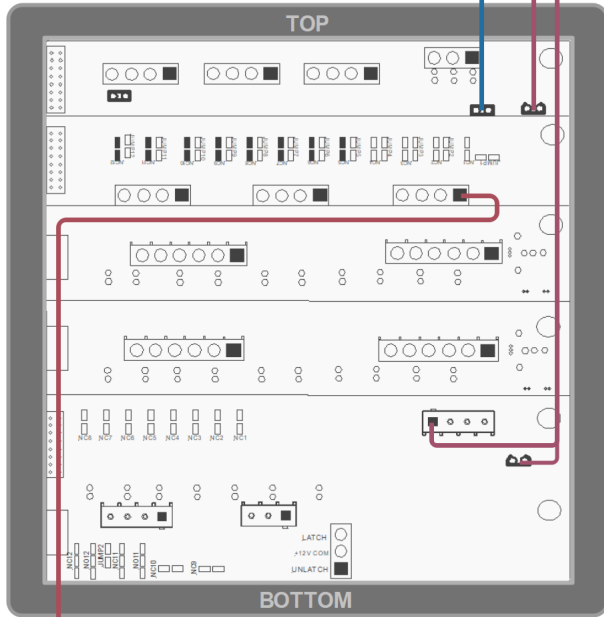

Opt Truma Water Heater
(Const.)



Electric Water Heater



Gas Water Heater



G12 Panel
@ Foot of Bed
Tiffin P/N: 5104413

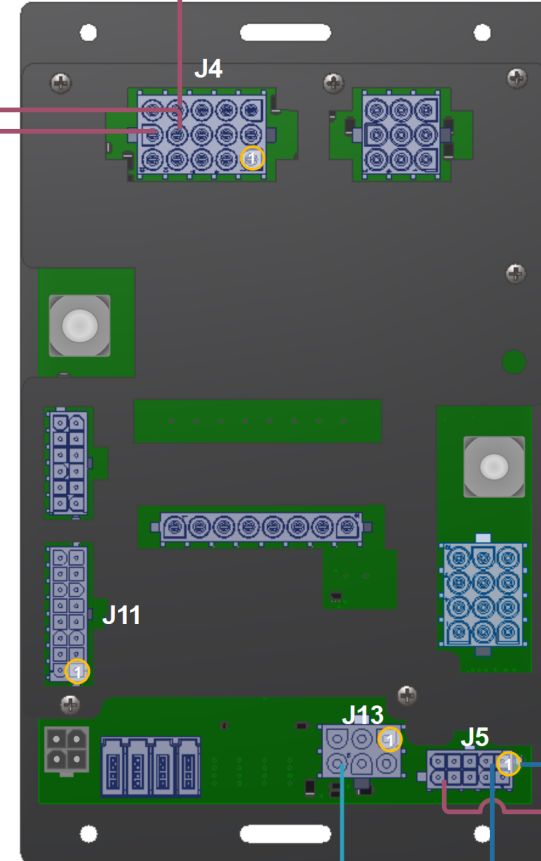

Water Pump



Water Pump Rocker Switch
@ Wet Bay

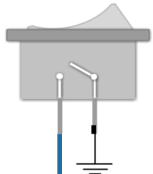

**2021 Tiffin Allegro RED 340
Battery Merge System
(Components not to scale)**

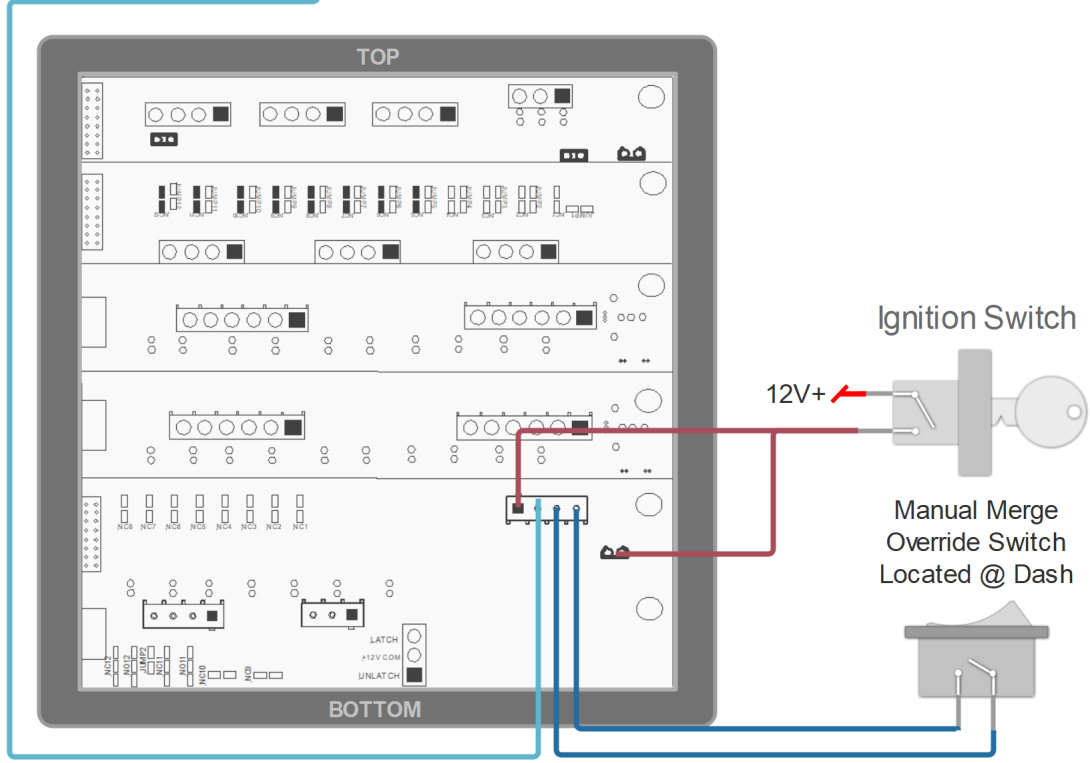
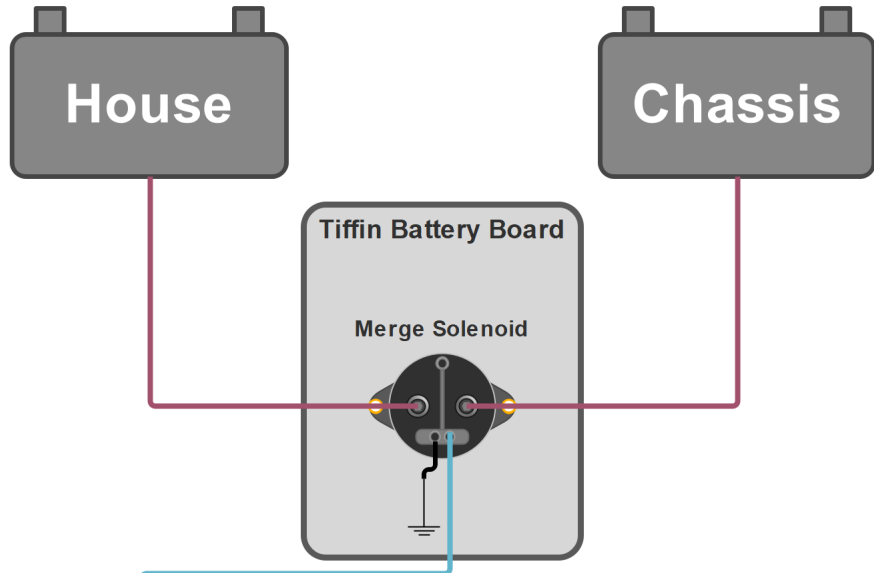

G12 Panel
@ Rear Closet
Tiffin P/N: 5104413

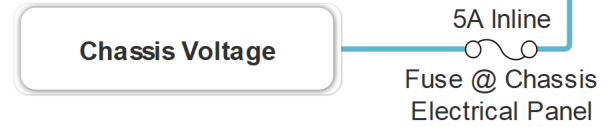
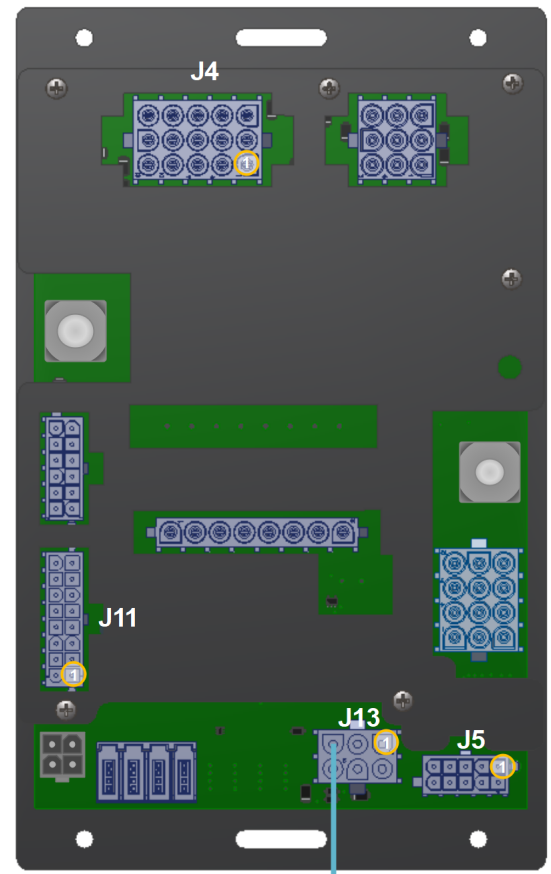

The RED 340 does not have an auto-merge function. The chassis batteries are charged by a trickle charger. Please contact Tiffin Motorhomes for more information

2021 Tiffin Allegro RED 340

Network Connectors and Related Parts

(Components not to scale)

G3 Terminator Tap
Tiffin P/N: 5051935

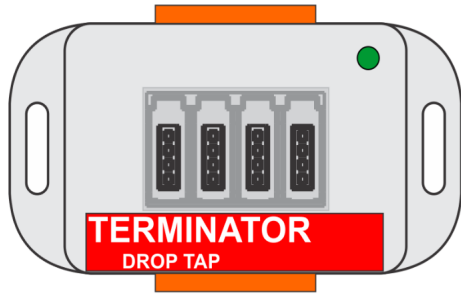

G3 Common Tap
Tiffin P/N: 5027834

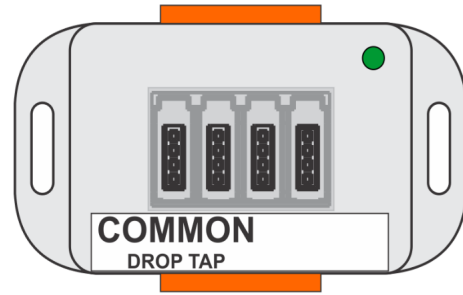

G4 Common Drop Tap
Tiffin P/N: 5016592



Mini-Clamp Plug
Tiffin P/N: 5066157



G4 Terminator Drop Tap
Tiffin P/N: 5051936



Mini-Clamp Socket
Tiffin P/N: 5066158



4 Pos Wago Connector
Tiffin P/N: 5015508

