

so .The Adv... Starts Now. Explore. Find Out. Live. Pre...

2026

Tiffin Phaeton

Integration Schematic



SPYDER
CONTROLS CORP

Phaeton Phaeton Phaeton Phaeton Phaeton



1-5	Module Locations	13	Mid M1 HC Relay
6	Front M1 Overview	14	Mid M1 Low Current Card
7	M1 Slide Card	15	Mid M1 RSI-12
8	Tiffin Slide Adapter	16	Rear M1 Overview
9	Front M1 HC Relay	17	Rear M1 Cards 1 & 2
10	Front M1 Breaker (Card 3)	18	Rear M1 Cards 3 & 4
11	Front M1 Breaker (Card 4)	19	Interior Lighting
12	Mid M1 Overview		

Schematic Connections Legend

	Constant Ground
	Constant 12V+
	Switched Ground
	Switched 12V+
	Reverse Polarity
	Signal
	120V AC Line
	Network

20 Exterior Lighting

21 Slides

22 HVAC

23 Floor Heat

24 Vent Fans

25 Tanks

26 Bed Lift

27 MoRyde TV Lift

28 Whisper Ride TV Lift

29 TV Lift Location

30 Shades

31 HCR-11

32 Merge System

33 Merge Logic

34 EMS

Schematic Connections Legend

	Constant Ground
	Constant 12V+
	Switched Ground
	Switched 12V+
	Reverse Polarity
	Signal
	120V AC Line
	Network

35	Inverter Assist
36	Wireless Switches
37	Generator
38	Mechanical
39	Blue Network (Port 1)
40	Blue Network Continued
41	Yellow Network (Port 2)
42	Orange Network (Port 3)

43	Orange Network (Port 4)
44	Ports 5 & 6
45	Always On
46	DCD Panel
47	Power Diagram
48	Power Diagram Continued
49	Connectors

Schematic Connections Legend

	Constant Ground
	Constant 12V+
	Switched Ground
	Switched 12V+
	Reverse Polarity
	Signal
	120V AC Line
	Network

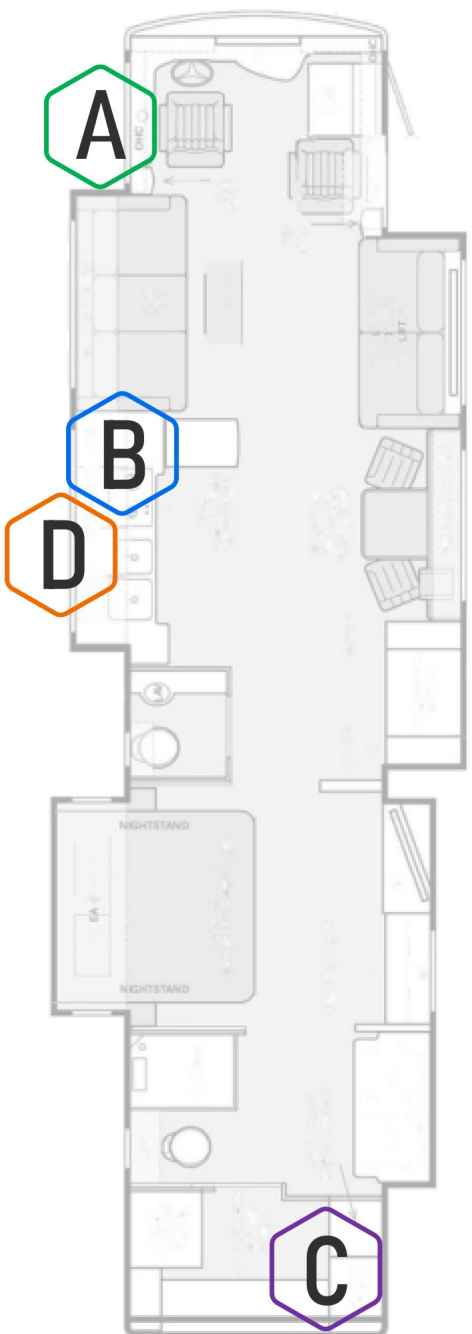

Front M1 Panel



Spyder Part #
BSSPZZTED-1

Tiffin Part #
5126983

Dimensions
10" X 7.8"

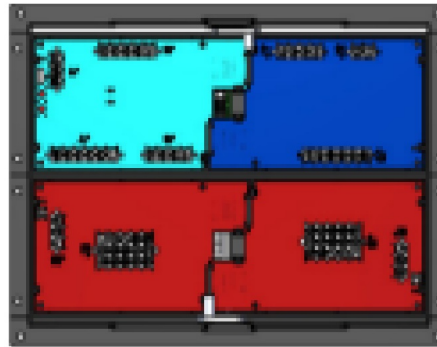

D/S Ext Compartment



Mid M1 Panel



Spyder Part #
BENCZM4C2

Tiffin Part #
5145849

Dimensions
10" X 7.8"

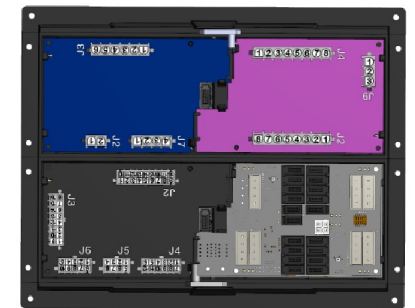

Inverter Bay



Rear M1 Panel



Spyder Part #
BENCZM6DP

Tiffin Part #
5127300

Dimensions
9.1" X 10"

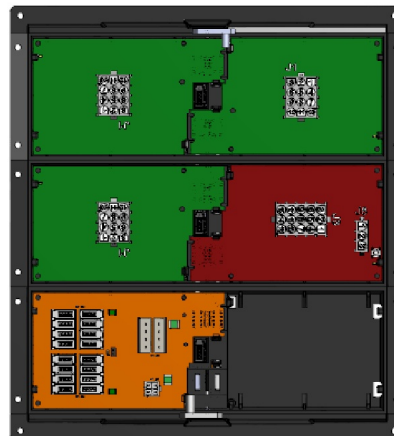

Rear Closet



DCD Panel



Spyder Part #
BENCZ38DP

Tiffin Part #
5127298

Dimensions
13.5" X 12.5"

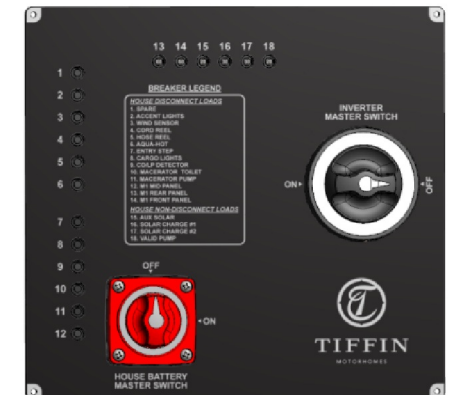

Inverter Bay



E 10" Pro LCD



Spyder Part #
BSSPZZXF

Dimensions
10.5" X 7.3"



Hall Wall

F Mira Module



Spyder Part #
BMODZ56VF

Tiffin Part #
5114034

Dimensions
4" X 2.5"



Front Overhead Cabinet

G HCR15 TV Lift



Spyder Part #
BMODZQFCN-A

Tiffin Part #
5134953

Dimensions
3" X 3"

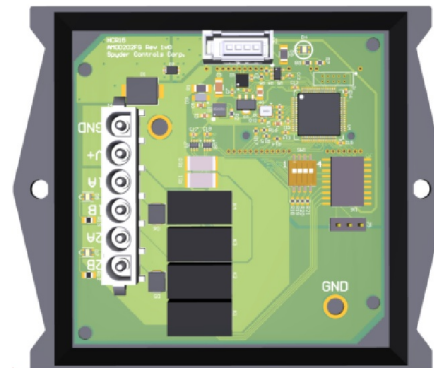

Rear Closet

H Bridge Module



Spyder Part #
BMODZTCT0

Tiffin Part #
5127271

Dimensions
2.7" X 2.7"

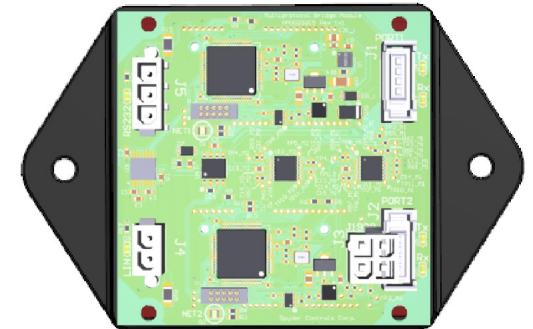

Rear Closet

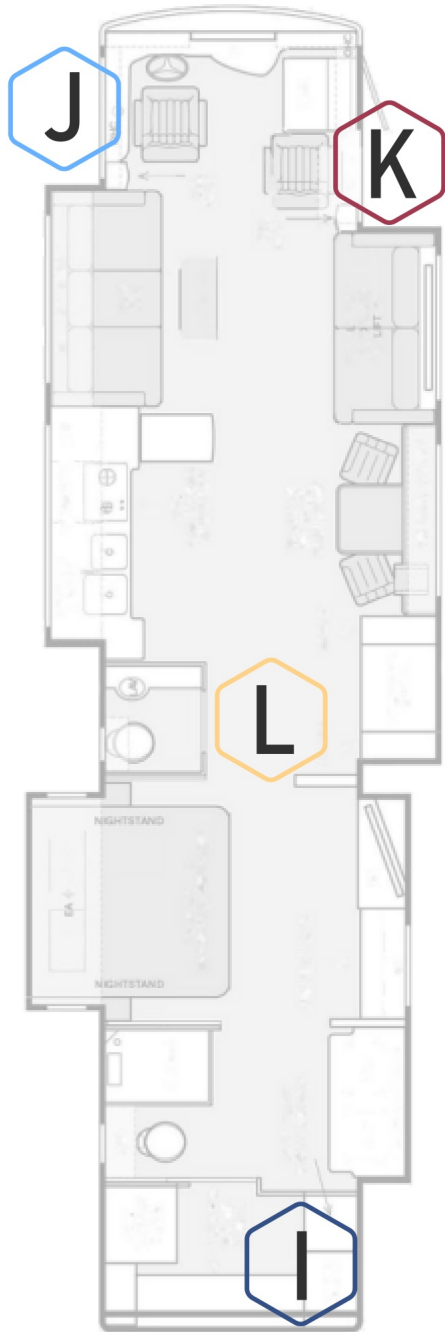

I ACR3

i

Spyder Part #
BMODZYACG-B

Tiffin Part #
5091114

Dimensions
6" X 4.8"

Rear Closet

A photograph of the ACR3 component, which consists of a circular ring with a green cable and a rectangular metal housing.

J HCR-12

i

Spyder Part #
BMODZJ2T0

Tiffin Part #
5076028

Dimensions
8" X 3"

Rear Closet

A photograph of the HCR-12 component, which is a blue printed circuit board (PCB) with various electronic components and connectors.

K Dash Shade Module

i

Spyder Part #
BMODZMKM1-T

Tiffin Part #
5127302

Dimensions
5.4" X 3.5"

P/S Front Overhead Cabinet

A photograph of the Dash Shade Module, which is a rectangular circuit board with a pinkish-purple surface and various components, including connectors labeled J4 and J2.

L RF Hub

i

Spyder Part #
BMODZRFT0-W

Tiffin Part #
5141264

Dimensions
5.1" DIA

Ceiling

A photograph of the RF Hub, which is a circular, metallic-looking component with a central hole.

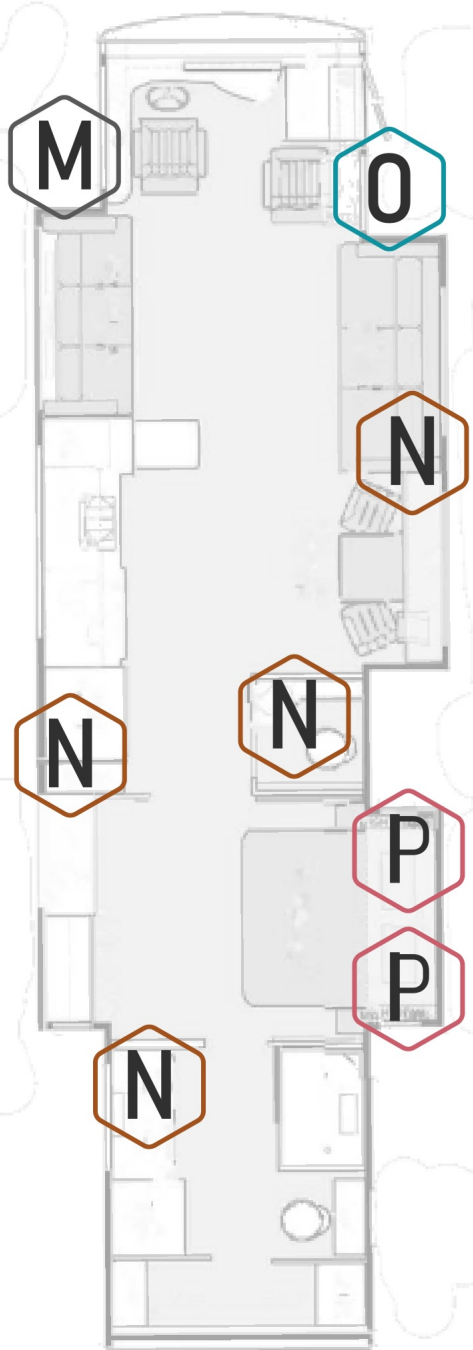

M Terminator
HCR-11

i
Spyder Part #
BMODZGAN6-1
Tiffin Part #
5131310
Dimensions
2.5" X 2"

Front D/S Compartment

The image shows a green printed circuit board (PCB) for the Terminator HCR-11. It features two multi-pin connectors labeled J1 and J2. Text on the board includes 'HCR11 Rev 1v0', 'AM0D202FA', and 'Spyder Controls Corp.'.

N 3.5" LCD

i
Spyder Part #
BSSPZZTED
Tiffin Part #
5127291
Dimensions
4.5" X 2.9"

Interior

The image shows a small, rectangular, black LCD screen with a dark display area.

O 5" Exterior
LCD

i
Spyder Part #
BSSPZZZEN
Tiffin Part #
5145817
Dimensions
5.9" X 4"

Outside Entry Door

The image shows a rectangular LCD screen with a black bezel and a light blue display area.

P 5" LCD

i
Spyder Part #
BSSPZZREK
Tiffin Part #
5127269
Dimensions
5.7" X 3.6"

Interior

The image shows a rectangular LCD screen with a black bezel and a grey display area.



Q RSI-11



Spyder Part #
BMODZQCZA-E

Tiffin Part #
5127304

Dimensions
2.7" X 2.7"

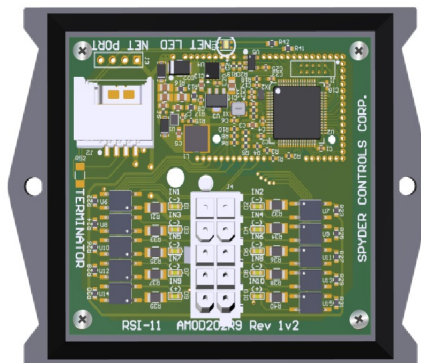

 **Front D/S Compartment**

M1 Slide Card

- Awning Constant
- Undercoach Constant
- Slide Breaker #1
- Slide Breaker #2
- Slide Breaker #3
- Ignition (12V)
- Park Brake (GND)
- P/S FR Slide EXT
- P/S FR Slide RET
- D/S FR Slide EXT
- D/S FR Slide RET
- P/S RR Slide EXT
- P/S RR Slide RET
- D/S RR Slide EXT
- D/S RR Slide RET
- Hydraulic Pump

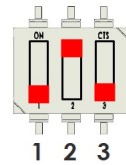

Dip Switch Settings

- | | |
|---|------------|
| 1 | OFF (Down) |
| 2 | ON (Up) |
| 3 | OFF (Down) |

Front M1 Panel

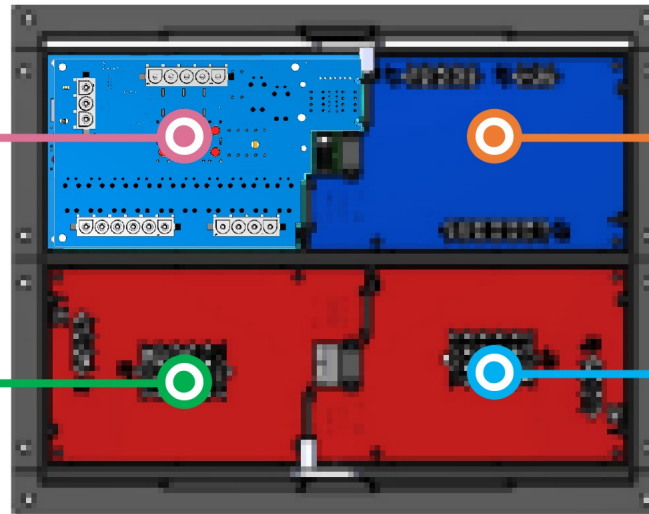

M1 High Current

- Windshield Accent
- Water Pump
- Headlights
- Door/Assist Handle
- Slide Box
- U-Coach
- Awning Lt
- Road Lt
- Porch Lt
- Map
- Spare LS
- Spare LS

M1 Breaker (Card 3)

- Camera/Radio (IGN)
- Jack Buzzer (IGN)
- CB/Satellite
- Panel Lamp/Head LT (IGN)
- 12V Outlet 1/USB PWR
- HCR-11 PWR
- TV Relay/Fridge/Dash SHD MOD (IGN)
- HVAC Denso (IGN)
- Dock Light
- Entry Step SW
- IGN (+12V)

M1 Breaker (Card 4)

- 12V Outlet 2/ USB PWR
- Engine Preheat SW
- Electric Step Cover
- Power Window (IGN)
- D/S Mirror PWR (IGN)
- P/S Mirror PWR (IGN)
- Seat Power #1
- Seat Power #2
- Dash Shade Module
- Map Lt/Fans/Radio
- Radio Mem/XM PWR
- HVAC Denso
- IGN (+12V)

Front M1 Panel

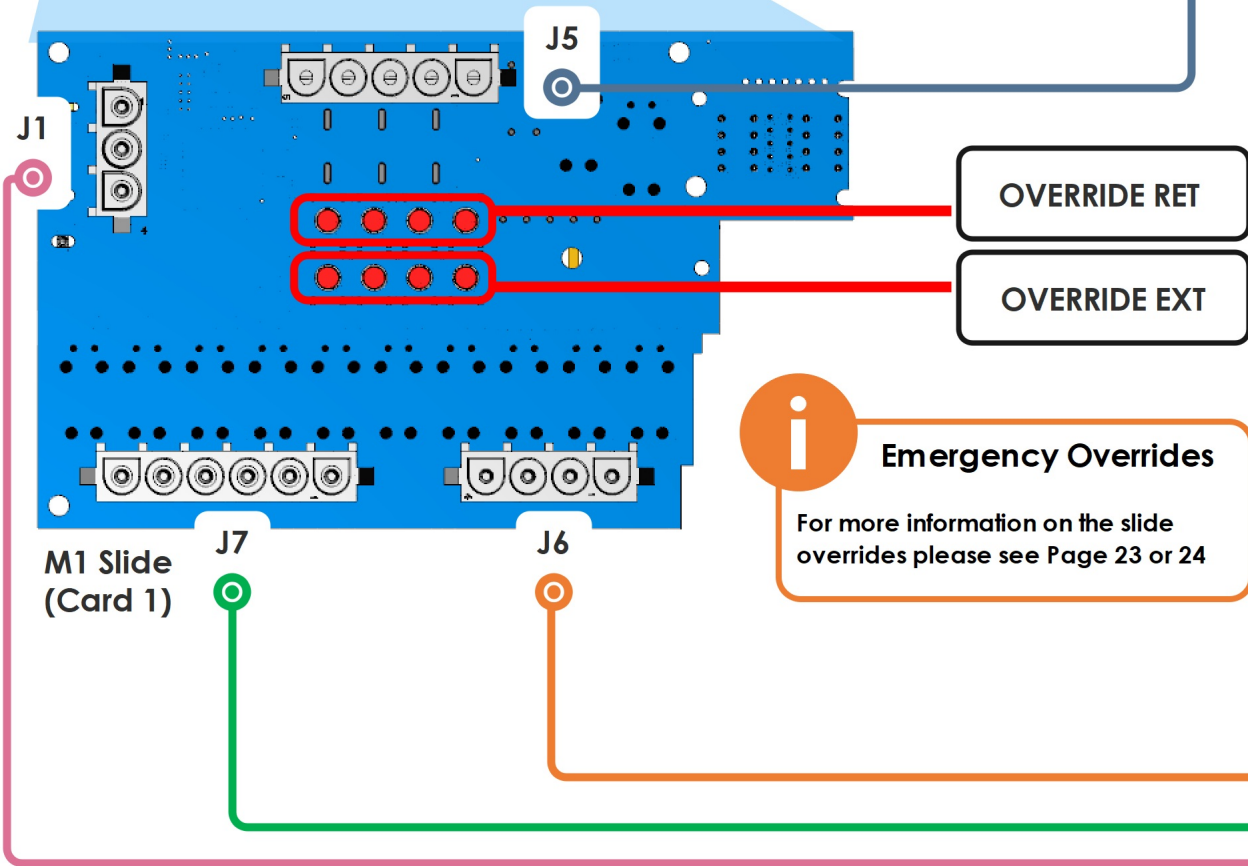
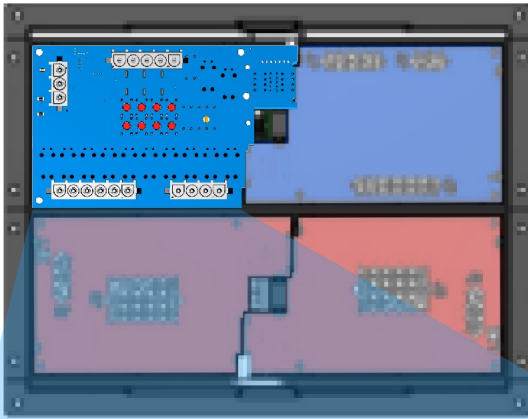

J5

1 Awning Constant	4 Slide Breaker #2
2 Undercoach Constant	5 Slide Breaker #3
3 Slide Breaker #1	

J6

1 P/S FR Slide Ext	3 D/S FR Slide Ext
2 P/S FR Slide Ret	4 D/S FR Slide Ret

J7

1 P/S RR Slide Ext	4 D/S RR Slide Ret
2 P/S RR Slide Ret	5 Hydraulic Pump
3 D/S RR Slide Ext	6 Spare

J1

1 Ignition (+12V)	3 N/A
2 Park Brake (GND)	

i **Emergency Overrides**
 For more information on the slide overrides please see Page 23 or 24

M1 Slide Card

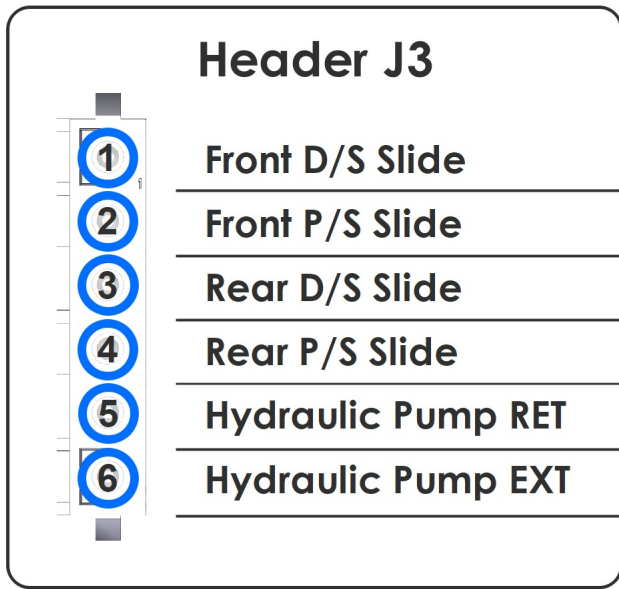
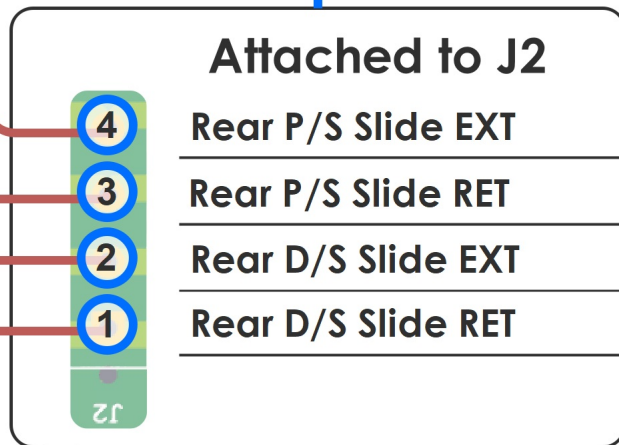
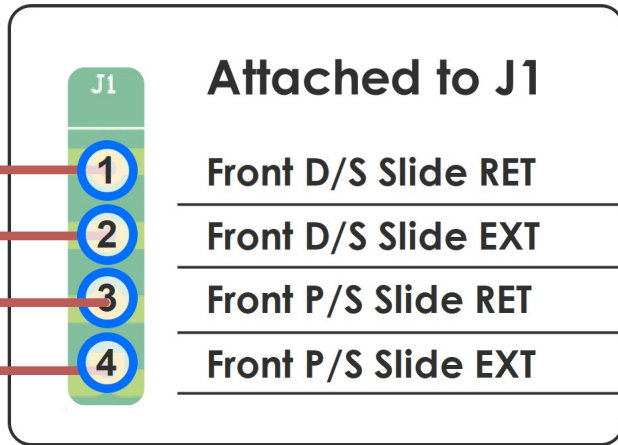
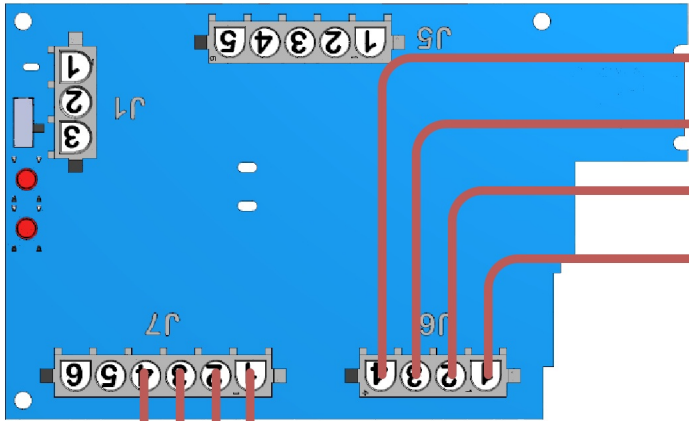

i Important Information
 Tiffin Slide Adapter, is only used when Lippert slides are implemented into the coach.

Tiffin Slide Adapter

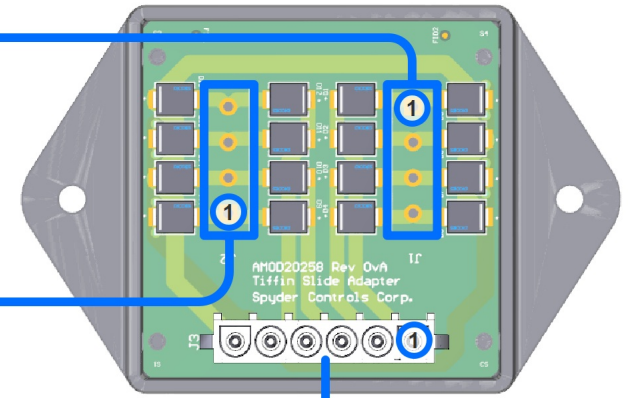

Front M1 Panel

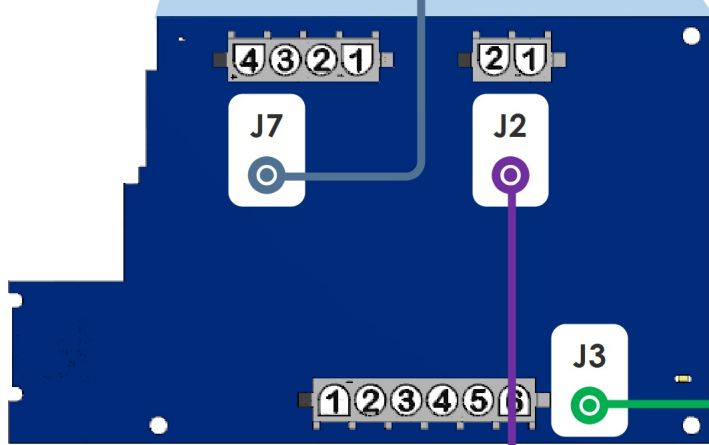
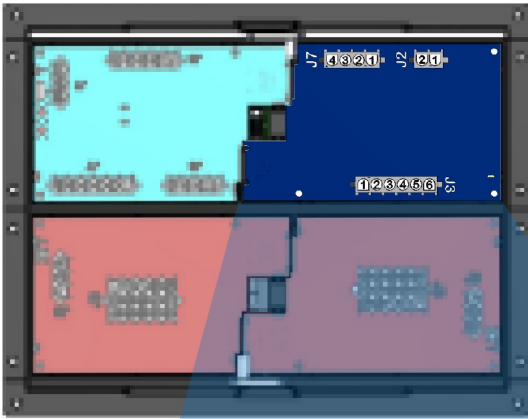

M1 HC Relay (Card 2)

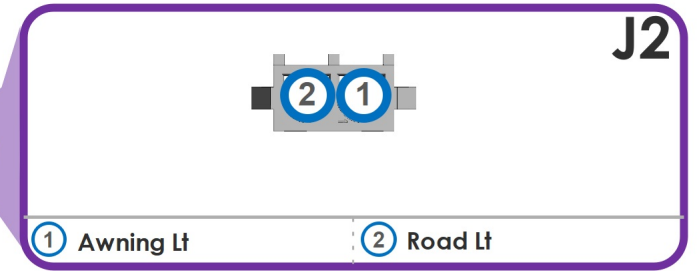
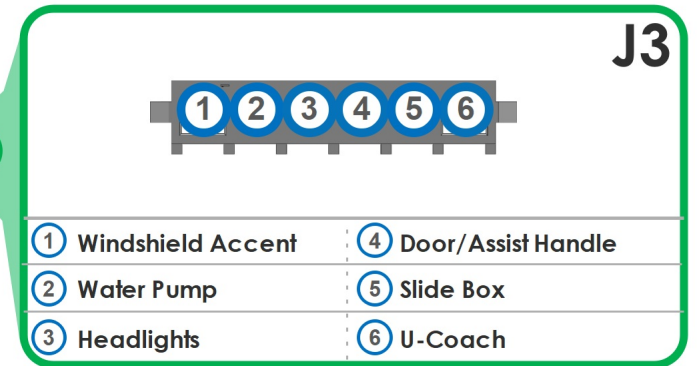
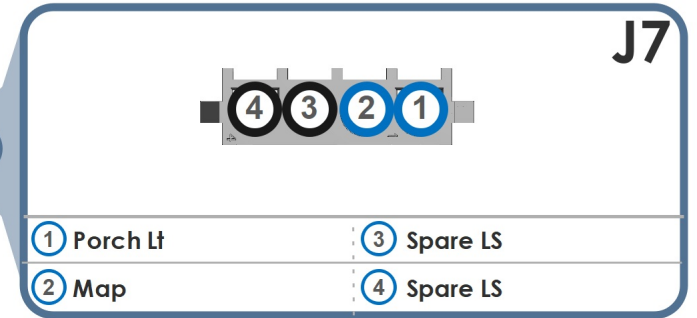

Front M1 Panel

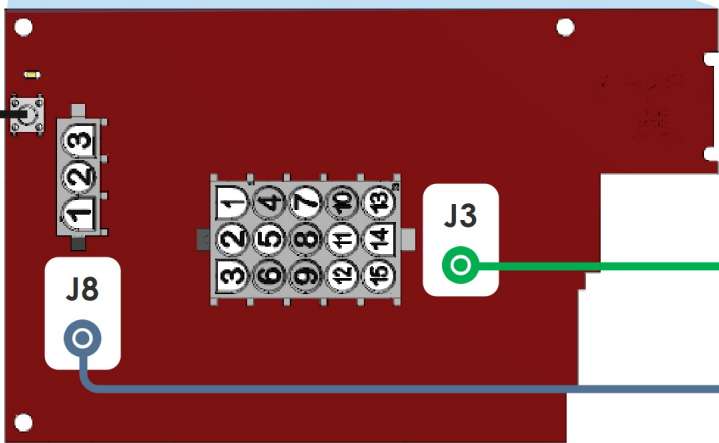
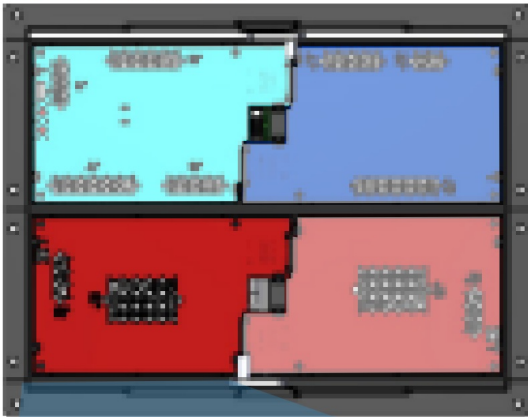

M1 Breaker (Card 3)

Breaker Reset

J3

1	4	7	10	13
2	5	8	11	14
3	6	9	12	15

① Spare	⑨ Panel Lamp/Head LT IGN
② Camera/Radio (IGN)	⑩ HVAC Denso (IGN)
③ Jack Buzzer (IGN)	⑪ N/A
④ Entry Step SW	⑫ 12V Outlet 1/USB PWR
⑤ N/A	⑬ TV Relay/Fridge/Dash SHD MOD (IGN)
⑥ CB/Satellite	⑭ Spare
⑦ Dock Light	⑮ HCR11 PWR
⑧ N/A	

J8

1	2	3
---	---	---

① IGN (+12V)	② N/A
③ N/A	

Front M1 Panel

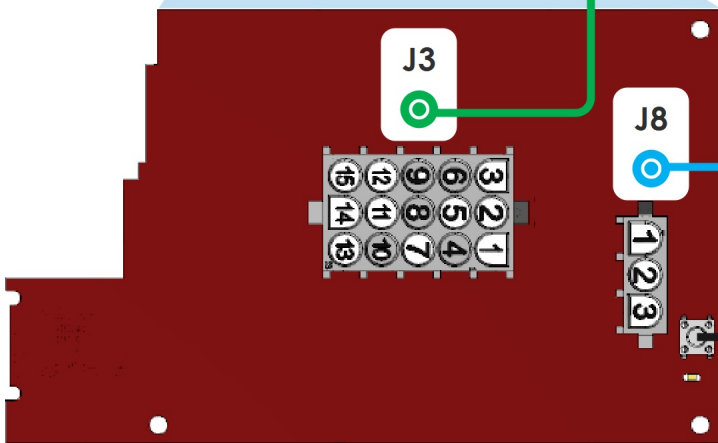
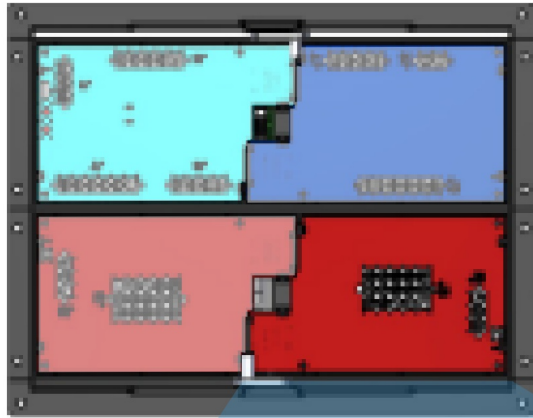

M1 Breaker (Card 4)

Breaker Reset

J3

15	12	9	6	3
14	11	8	5	2
13	10	7	4	1

① HVAC Denso	⑨ Power Window (IGN)
② 12V Outlet 2/USB PWR	⑩ Dash Shade Module
③ Engine Preheat SW	⑪ N/A
④ Radio Mem/XM PWR	⑫ D/S Mirror PWR (IGN)
⑤ N/A	⑬ Seat Power #2
⑥ Elect Step Cover	⑭ Seat Power #1
⑦ Map LT/Fans/Radio	⑮ P/S Mirror PWR (IGN)
⑧ N/A	

J8

①	②	③
---	---	---

① IGN (+12V)	② N/A
--------------	-------

High Current

- Bed Lift UP
- Bed Lift DOWN
- PS Fan HI
- PS Fan LO
- Bay Door Lock
- Bay Door Unlock
- Step Cover EXT
- Step Cover RET
- Door Awning EXT
- Door Awning RET
- Entry Door Lock
- Entry Door Unlock

Low Current

- Furnace FR
- Furnace RR
- Gen Start (GND)
- Gen Stop (GND)
- Galley SHD DN
- Galley SHD UP
- Galley NT SHD DN
- Galley NT SHD UP
- Sofa Day SHD UP
- Sofa Day SHD DN
- Sofa NT SHD DN
- Sofa NT SHD UP

Dip Switch Settings

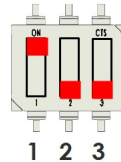

- | | |
|---|------------|
| 1 | ON (Up) |
| 2 | OFF (Down) |
| 3 | OFF (Down) |

Mid M1 Panel

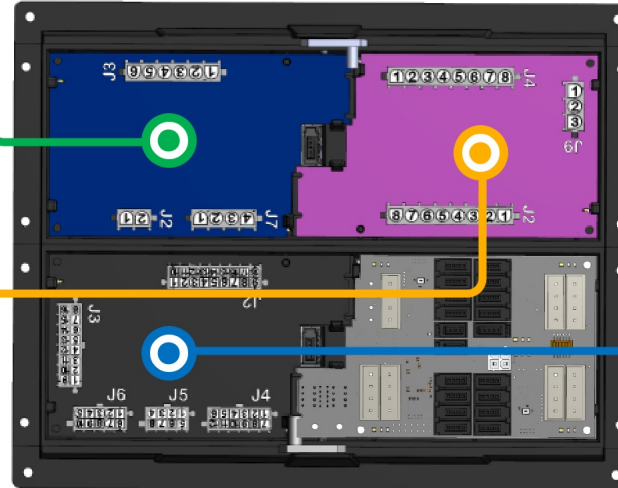

RSI-12

- IGN (+12V)
- GEN Fault (+12V)
- HSE Disconnect Sense (+12V)
- Bed Lift Plunger (+12V)
- Park Brake (GND)
- Water Pump (GND)
- Entry Door Pin SW (GND)
- Merge Input (GND)
- Dash Accent ON (GND)
- Dash Accent OFF (GND)
- LP Gas
- LP GND
- Spare
- GEN Run Signal
- RTC 12V Constant PWR
- FR Floor Heat Thermistor
- RR Floor Heat Thermistor
- Front A/C Thermistor
- Mid A/C Thermistor
- Rear A/C Thermistor
- Bay Thermistor
- Ext Temp

Mid M1 Panel

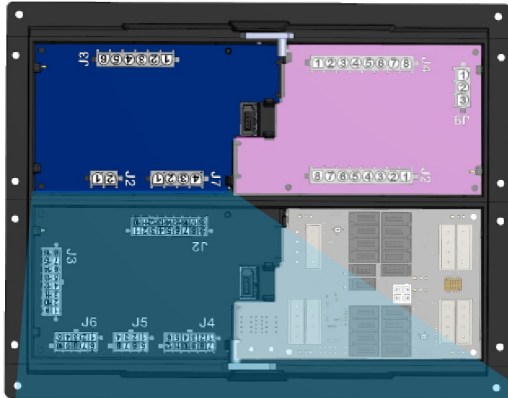

Mid M1 HC Relay (Card 1)

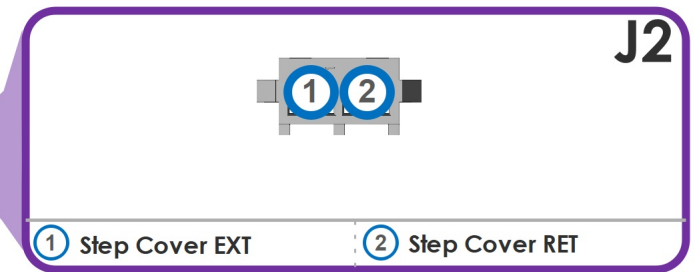
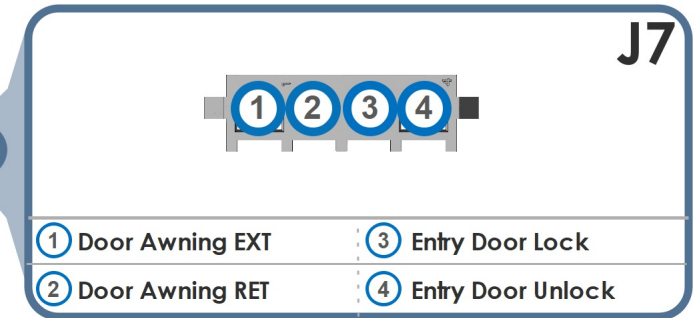
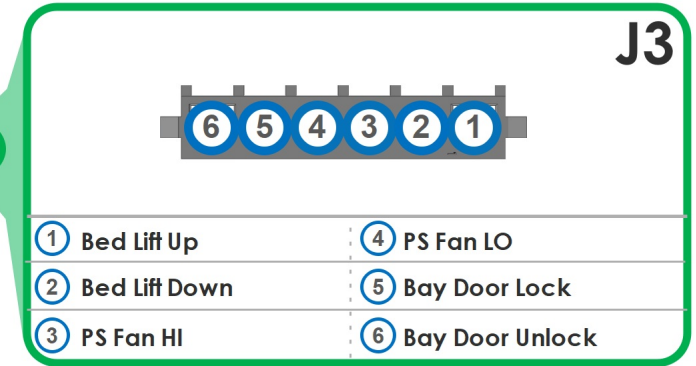
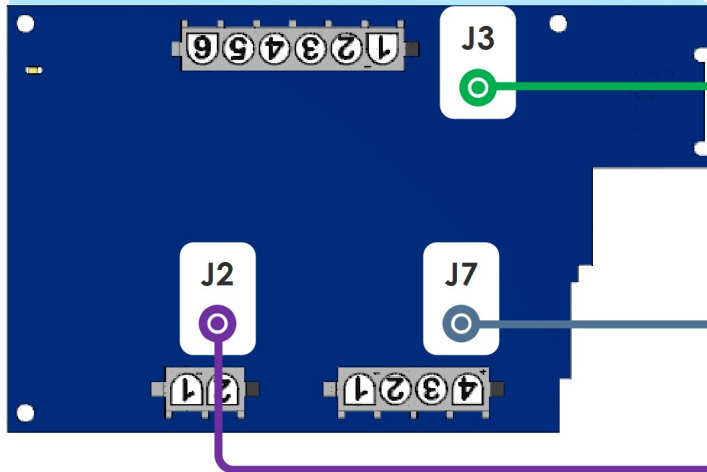

Mid M1 Panel

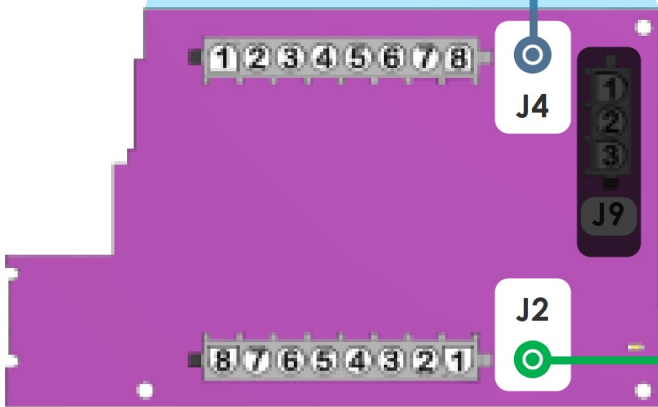
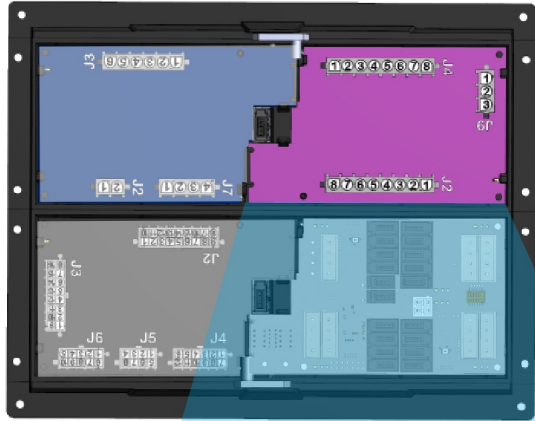

M1 Low Current

J4

1	2	3	4	5	6	7	8
1 Spare	2 Spare	3 Spare	4 Spare	5 Furnace FR	6 Furnace RR	7 GEN Start (GND)	8 GEN Stop (GND)

J2

8	7	6	5	4	3	2	1
1 Galley SHD DN	2 Galley SHD UP	3 Galley NT SHD DN	4 Galley NT SHD UP	5 Sofa Day SHD DN	6 Sofa Day SHD UP	7 Sofa NT SHD DN	8 Sofa NT SHD UP

Mid M1 Panel

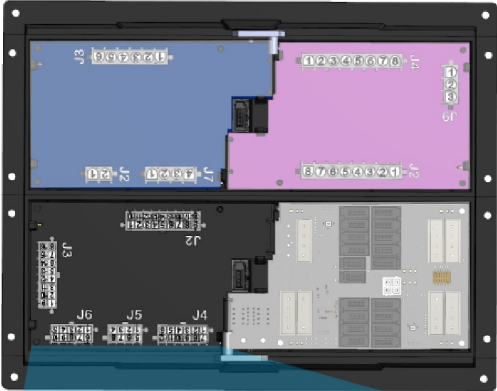

RSI-12

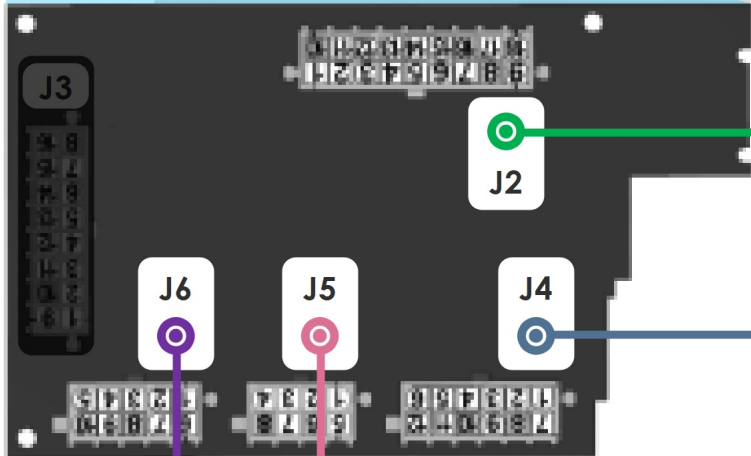

J2

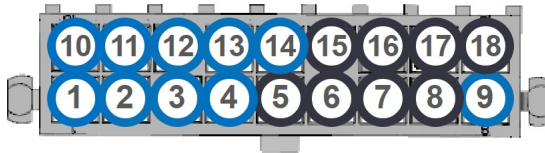

1	IGN (+12V)	10	Water Pump (GND)
2	GEN Fault (+12V)	11	Entry Door Pin SW (GND)
3	HSE Disconnect Sense (+12V)	12	Merge Input (GND)
4	Bed Lift Plunger (+12V)	13	Dash Accent ON (GND)
5	Spare (+12V)	14	Dash Accent OFF (GND)
6	Spare (+12V)	15	A/C Override Sense (GND)
7	Spare (+12V)	16	Spare (GND)
8	Spare (+12V)	17	Spare
9	Park Brake (GND)	18	Spare

J4

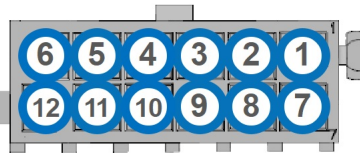

1	FR Floor Heat Therm Sig.	7	FR Floor Heat Therm GND
2	RR Floor Heat Therm Sig.	8	RR Floor Heat Therm GND
3	Front A/C Therm Sig.	9	Front A/C Therm GND
4	Mid A/C Therm Sig.	10	Mid A/C Therm GND
5	Rear A/C Therm Sig.	11	Rear A/C Therm GND
6	Bay Therm Sig.	12	Bay Therm GND

J5

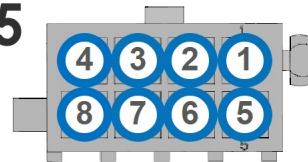

1	Spare	5	Spare
2	Spare	6	Spare
3	Spare	7	Spare
4	EXT Temp Sig.	8	Ext Temp GND

J6

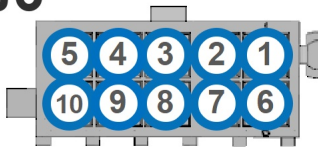

1	LP Gas	6	LP GND
2	Spare	7	Spare
3	Spare	8	Spare
4	Spare	9	GEN Run Signal (+12v)
5	Spare	10	RTC 12V Constant PWR

M1 Dimmer Card 1

- Entry Lt
- Main OH/Liv Lt
- PS Ceiling Lt
- DS Ceiling Lt
- Hall Lt
- FR Sconce
- RR Sconce
- DS Slide
- PS Slide
- FR Courtesy
- RR Courtesy

M1 Dimmer Card 3

- TV Accent Lt
- Closet Lt
- Floor HT FR Zone
- Floor HT RR Zone
- Fireplace Override
- Rear TV Lift Up
- Rear TV Lift Down
- Ceiling Fan HI
- Ceiling Fan LO

Dip Switch Settings

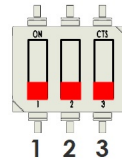

- | | |
|---|------------|
| 1 | OFF (Down) |
| 2 | OFF (Down) |
| 3 | OFF (Down) |

Rear M1 Panel

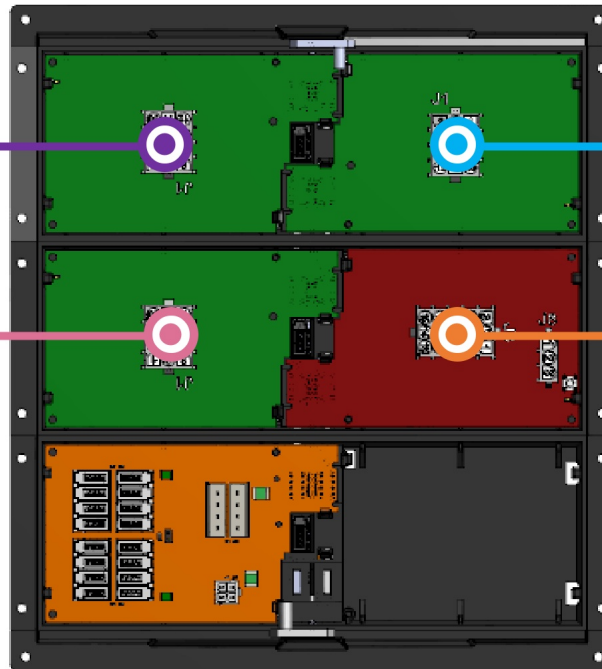

M1 Dimmer Card 2

- Bedroom Ceiling Lt
- Bed Accent Lt
- FR Accent 1
- FR Accent 2
- Task Lt
- Mid Bath Lt
- Mid Bath Vanity Lt
- Rear Bath Lt
- Rear Bath Vanity Lt
- FR Bed Reading
- RR Bed Reading
- RR Accent

M1 Breaker Card 4

- Basement 12v PWR/Ext TV 12v
- SEELEVEL
- Front Furnace
- Prox. AC RLY SW/Gasley Motion Lt
- Switcher/LP/IR
- Vent Fan PWR
- Rear Furnace
- Mid Toilet
- Front Pass Slide/Dinette SHD
- Bed Slide/Wall USB
- Truma Water Heater
- FR/RR TV Lift

Rear M1 Panel

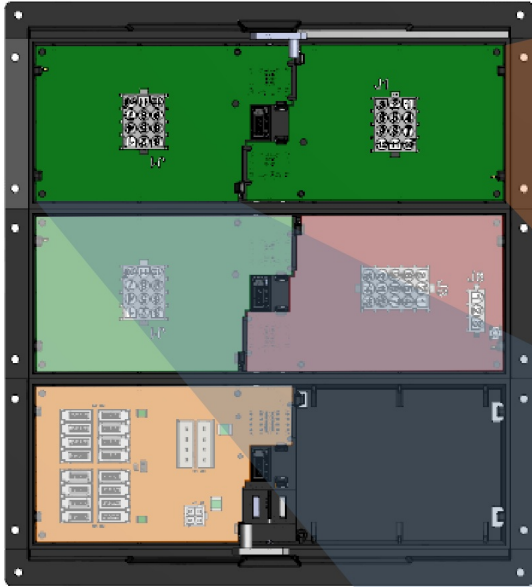

M1 Dimmer (Card 2)

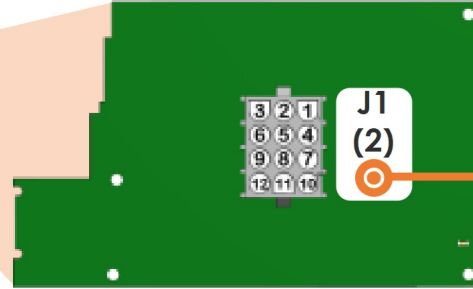

J1 (2)

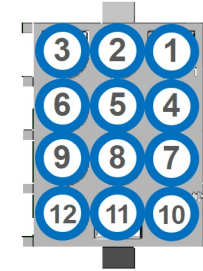

- | | |
|----------------------|-----------------------|
| 1 Bedroom Ceiling Lt | 7 Mid Bath Vanity Lt |
| 2 Bed Accent | 8 Rear Bath Lt |
| 3 FR Accent 1 | 9 Rear Bath Vanity Lt |
| 4 FR Accent 2 | 10 FR Bed Reading Lt |
| 5 Task Lt | 11 RR Bed Reading Lt |
| 6 Mid Bath Lt | 12 RR Accent |

M1 Dimmer (Card 1)

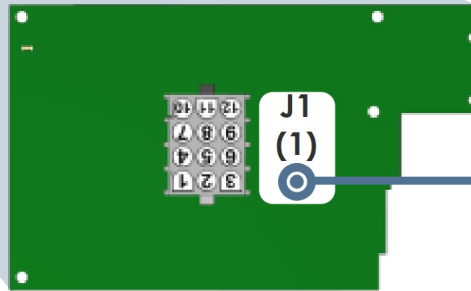

J1 (1)

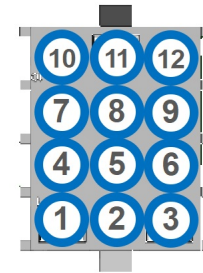

- | | |
|------------------|----------------|
| 1 Entry Lt | 7 FR Sconce |
| 2 Main OH/Liv Lt | 8 RR Sconce |
| 3 Spare | 9 DS Slide |
| 4 PS Ceiling Lt | 10 PS Slide |
| 5 DS Ceiling Lt | 11 FR Courtesy |
| 6 Hall Lt | 12 RR Courtesy |

Rear M1 Panel

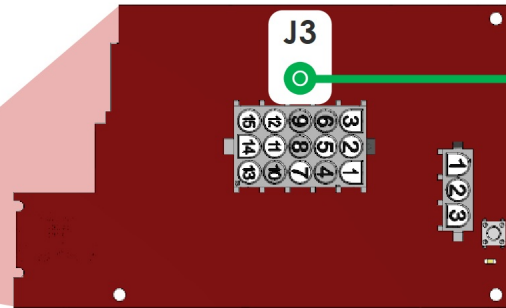
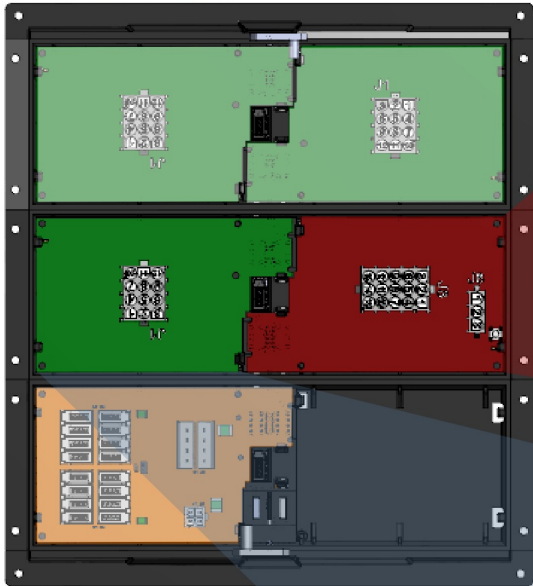

Rear M1 Breaker (Card 4)

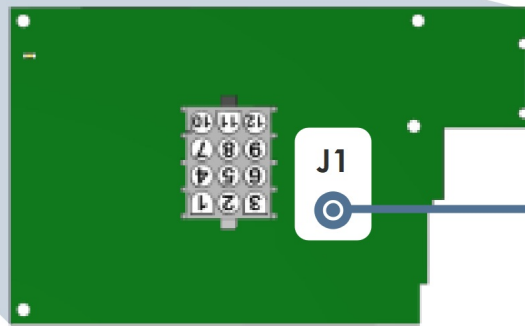

Rear M1 Dimmer (Card 3)

J3

15	12	9	6	3
14	11	8	5	2
13	10	7	4	1

1 FR/RR TV Lift	9 Prox. AC RLY SW/Gasley Motion Lt
2 Basement 12v PWR/Ext TV 12v	10 Front Pass Slide/Dinette SHD
3 SEELEVEL	11 N/A
4 Truma Water Heater	12 Switcher/LP/IR
5 N/A	13 Mid Toilet
6 Front Furnace	14 Rear Furnace
7 Bed Slide/Wall USB	15 Vent Fan Power
8 N/A	

J1

10	11	12
7	8	9
4	5	6
1	2	3

1 TV Accent Lt	7 Spare
2 Closet Lt	8 Fireplace Override
3 Spare	9 Rear TV Lift Up
4 Spare	10 Rear TV Lift Down
5 Floor HT FR Zone	11 Ceiling Fan HI
6 Floor HT RR Zone	12 Ceiling Fan LO

1

Dimmer Card 1

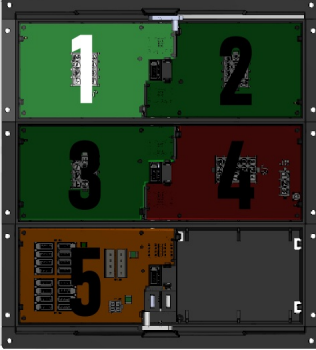

Rear M1 Panel

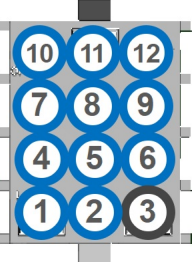

Outputs

① Entry Lt	⑦ FR Sconce
② Main OH/Liv Rm	⑧ RR Sconce
③ Spare	⑨ DS Slide
④ PS Ceiling Lt	⑩ PS Slide
⑤ DS Ceiling Lt	⑪ FR Courtesy
⑥ Hall Lt	⑫ RR Courtesy

2

Dimmer Card 2

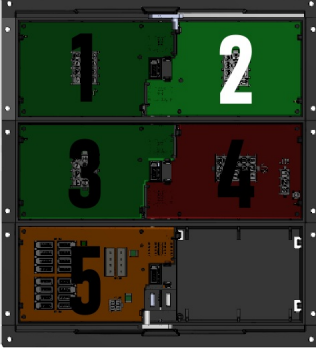

Rear M1 Panel

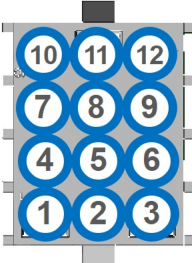

Outputs

① Bed Ceiling Lt	⑦ Mid Bath Vanity Lt
② Bed Accent	⑧ Rear Bath Lt
③ FR Accent 1	⑨ Rear Bath Vanity Lt
④ FR Accent 2	⑩ FR Bed Reading Lt
⑤ Task Lt	⑪ RR Bed Reading Lt
⑥ Mid Bath Lt	⑫ RR Accent

3

Dimmer Card 3



Rear M1 Panel

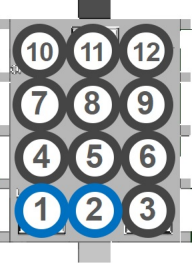

Outputs

① TV Accent Lt	⑦ Spare
② Closet Lt	⑧ N/A
③ Spare	⑨ N/A
④ Spare	⑩ N/A
⑤ N/A	⑪ N/A
⑥ N/A	⑫ N/A

Front M1 Panel

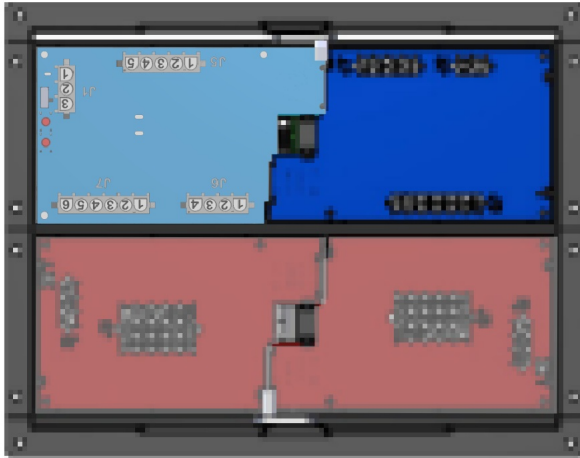

M1 HC Relay Card

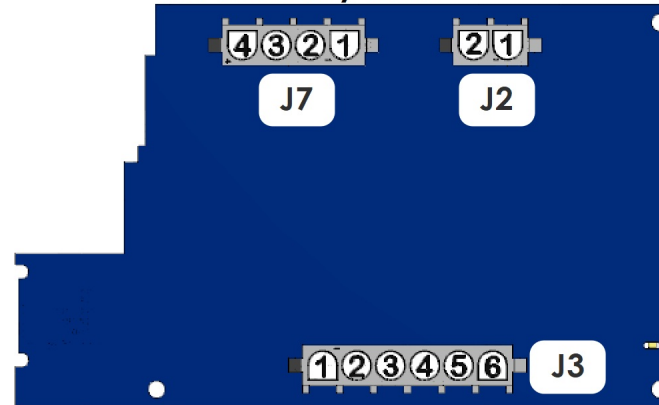

J3

① Windshield Accent	④ N/A
② N/A	⑤ Slide Box
③ Headlights	⑥ U-Coach

J7

① Porch Lt	③ N/A
② Map	④ N/A

J2

① Awning Lt	② Road Lt
-------------	-----------

Emergency Override
 Park brake and ignition must be on for slides to operate.
 In case of a system failure, use manual overrides on the slide card to operate slides.
 Engage overrides using a pen or other pointed object.

Ignition Switch

Park Brake Switch

RSI-12

- Slide Breakers**
- ⑤ Slide Breaker #3
 - ④ Slide Breaker #2
 - ③ Slide Breaker #1

- Hydraulic Pump**
- Power Output
- ⑤ Hydraulic Pump

- Rear Slide Outputs**
- D/S RR Slide RET ④
 - D/S RR Slide EXT ③
 - P/S RR Slide RET ②
 - P/S RR Slide EXT ①

- Front Slide Outputs**
- ① P/S FR Slide EXT
 - ② P/S FR Slide RET
 - ③ D/S FR Slide EXT
 - ④ D/S FR Slide RET

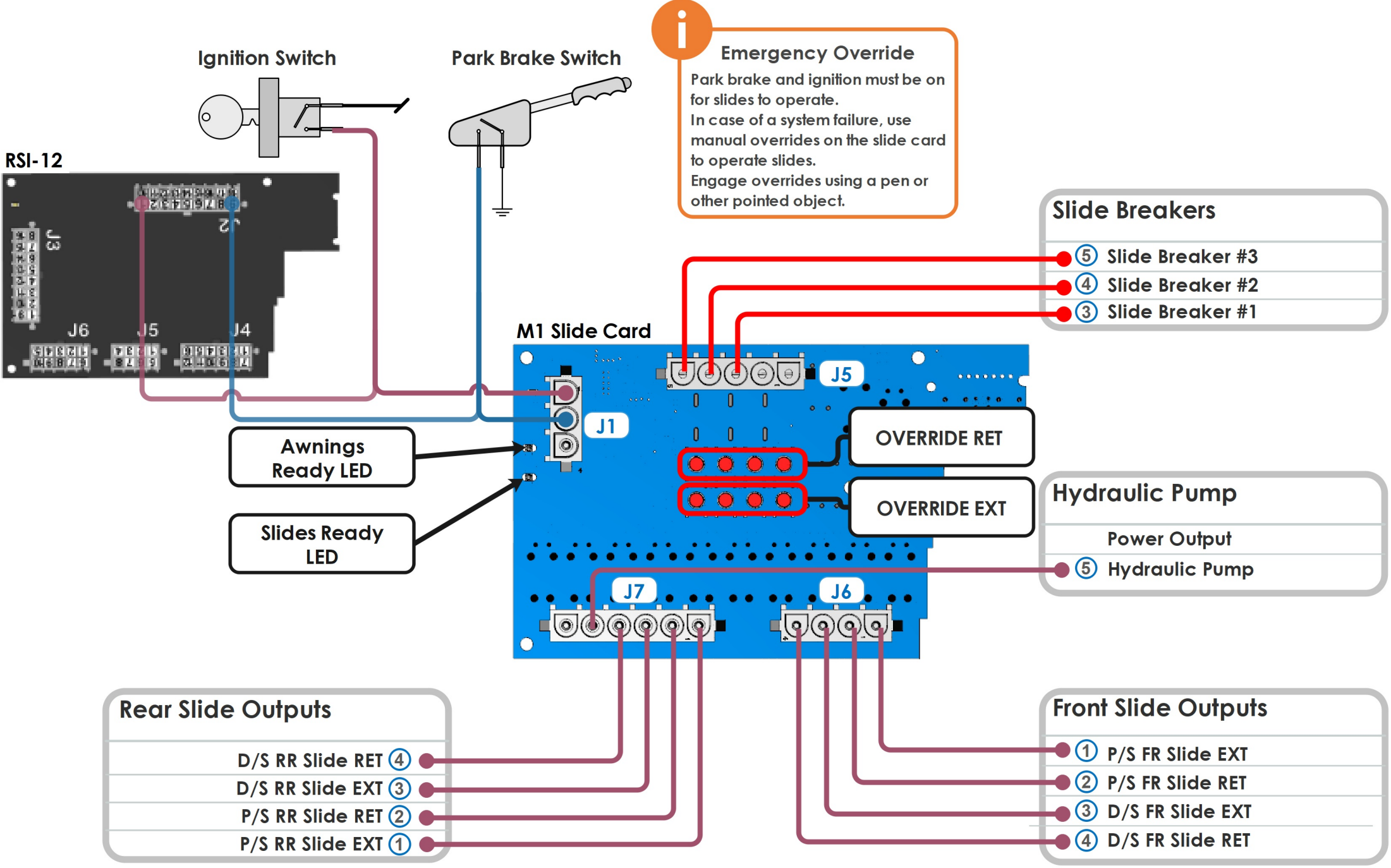

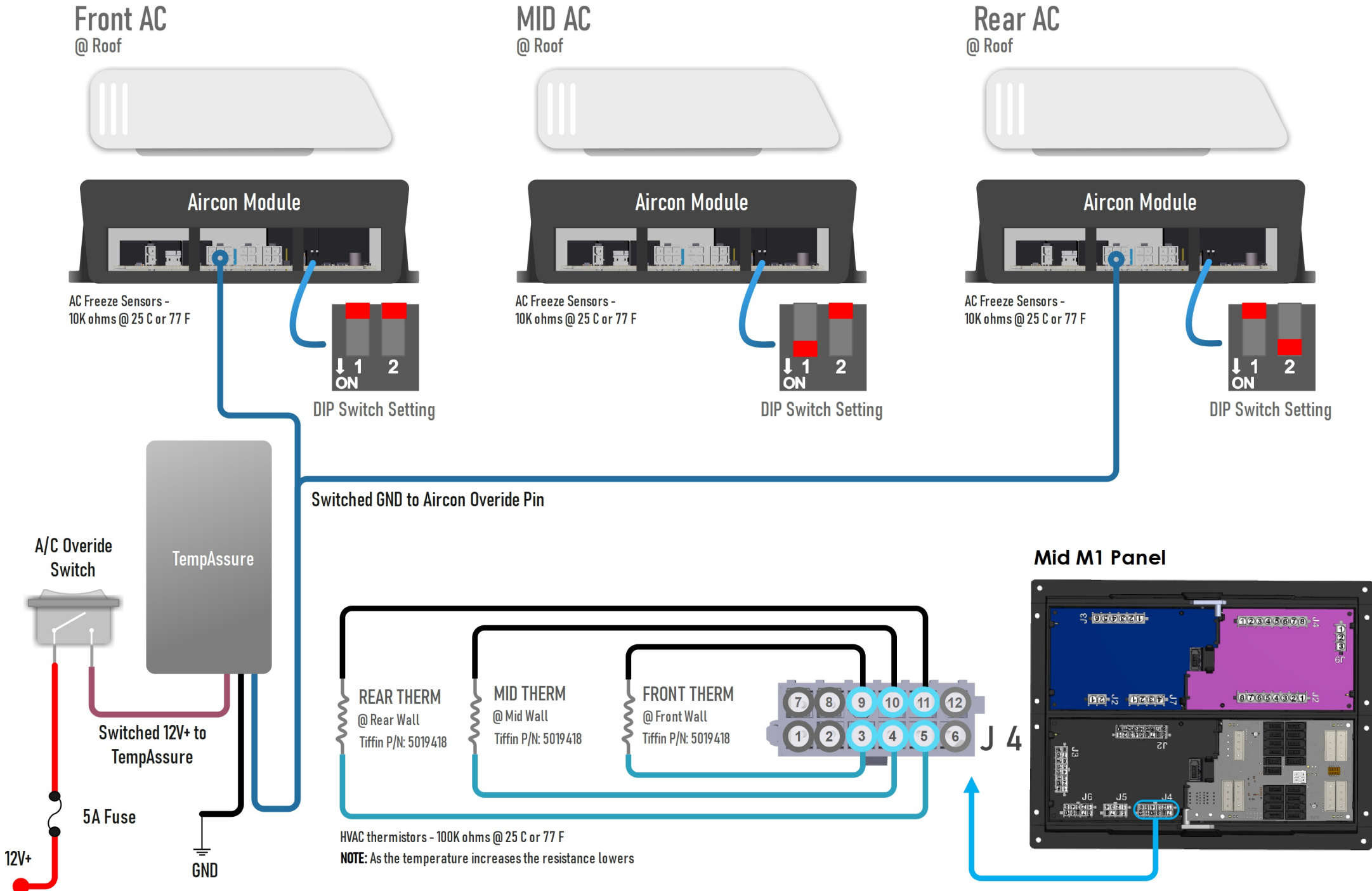

Mid M1 Panel

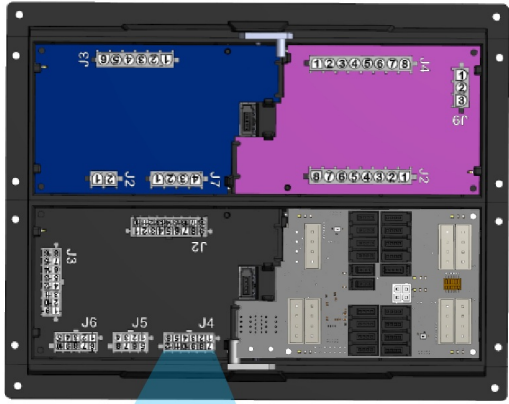

120V BREAKER PANEL @Rear Closet

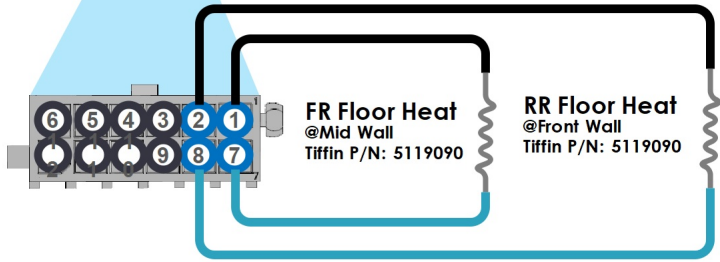
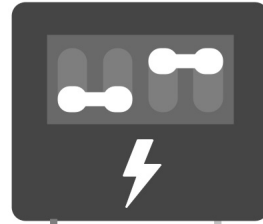

Rear M1 Panel Card 3

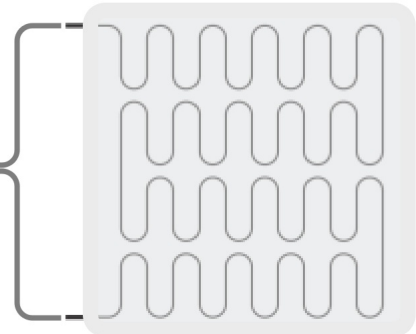
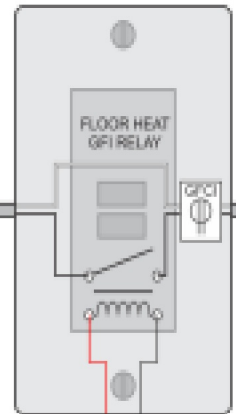
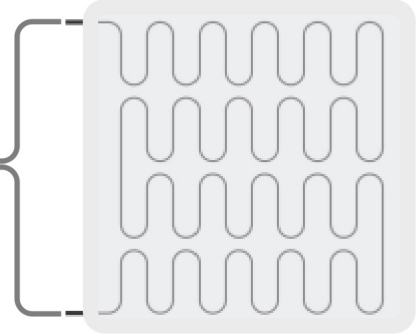
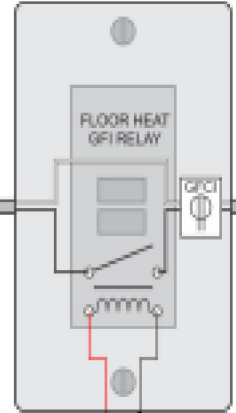
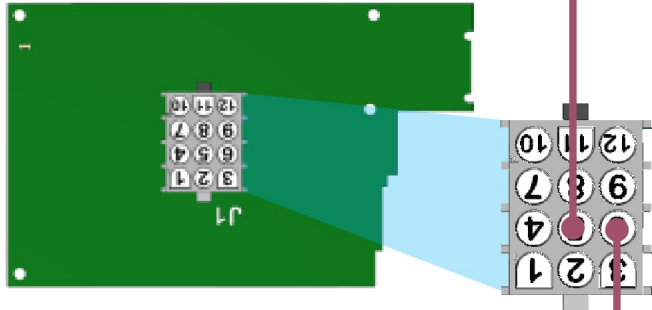

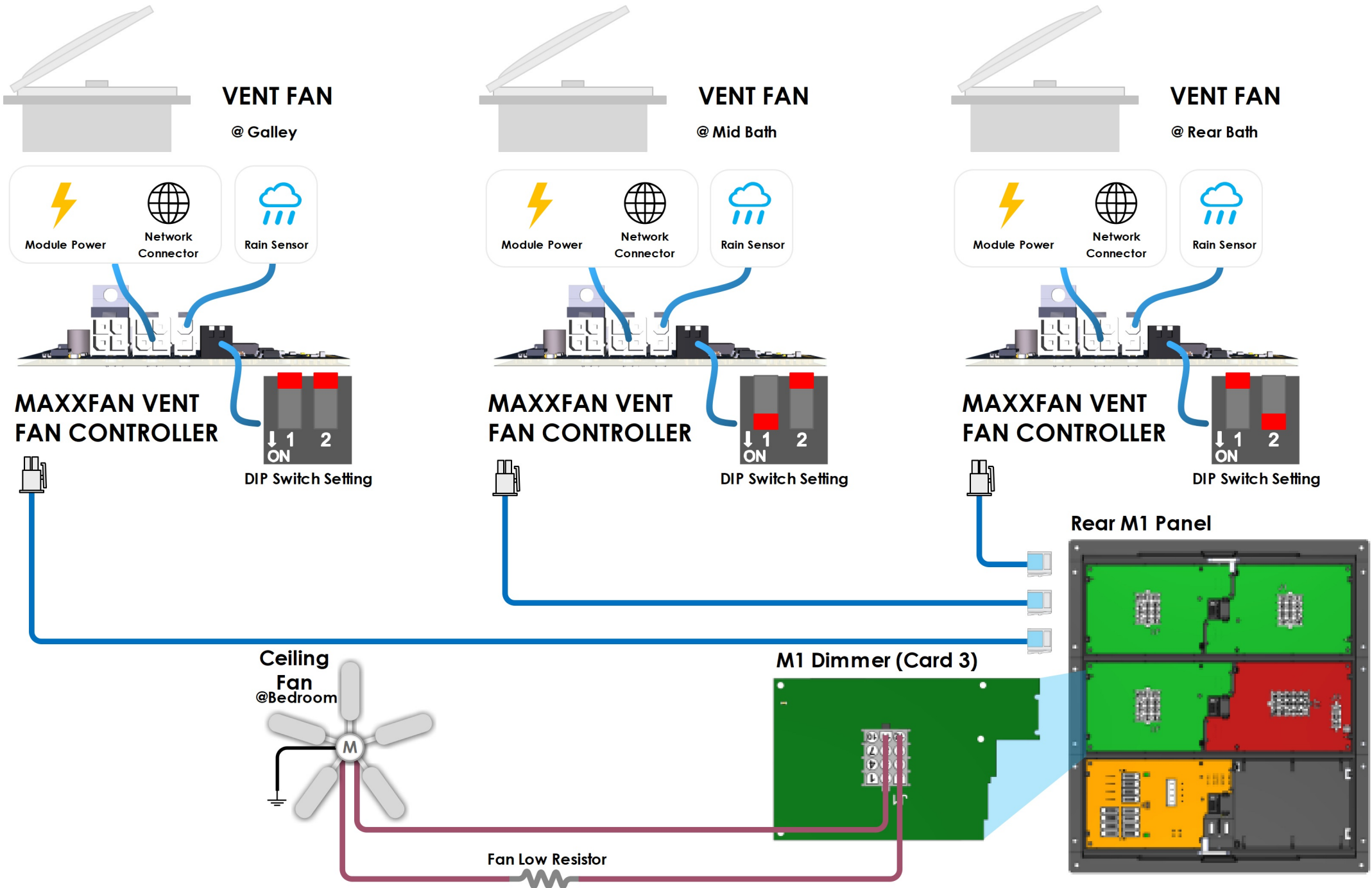

Mid M1 Panel

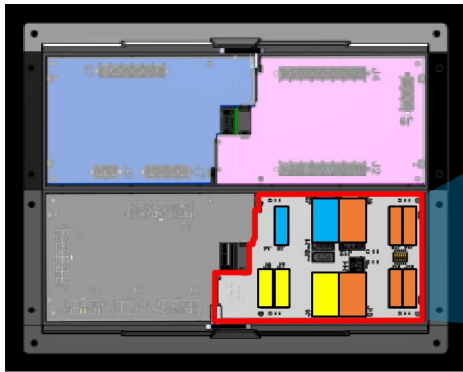

Can Router

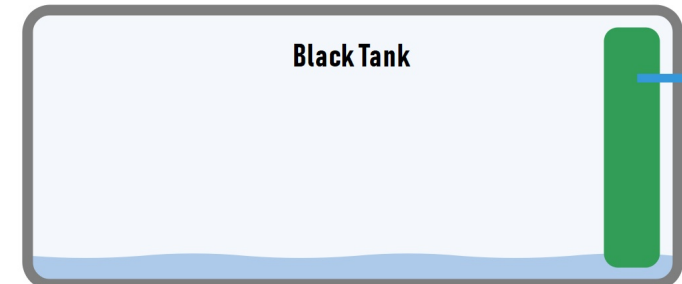
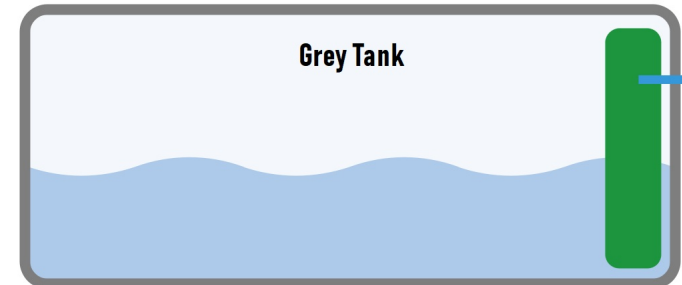
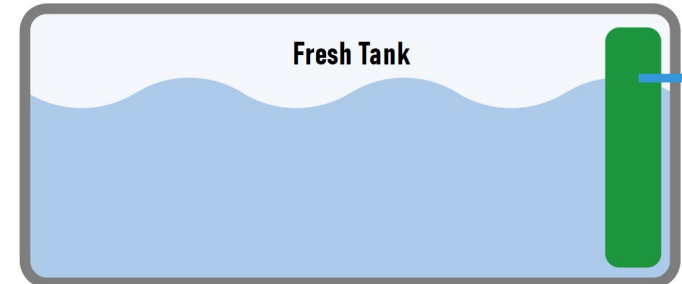
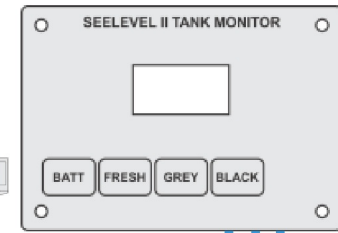
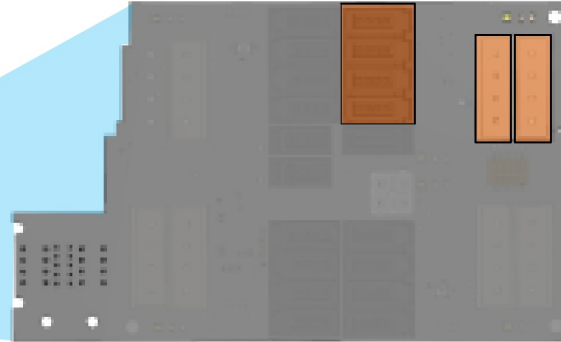

Seelevel Tank System

This coach is equipped with a Seelevel Tank sensing system 1 made by Garnet Industries. This tank system receives data from the strip sensors on the tank. The Seelevel monitor then transmits this data across the RV-C network.

The Spyder System detects the tank information broadcast by Seelevel. This information is displayed on all Spyder displays where tank information can be found.

If the tank information displayed on a Spyder System is incorrect the issue is not related to the Spyder System itself. The Spyder System only displays information broadcast by Seelevel.

If no tank information is present the Seelevel monitor may be offline.

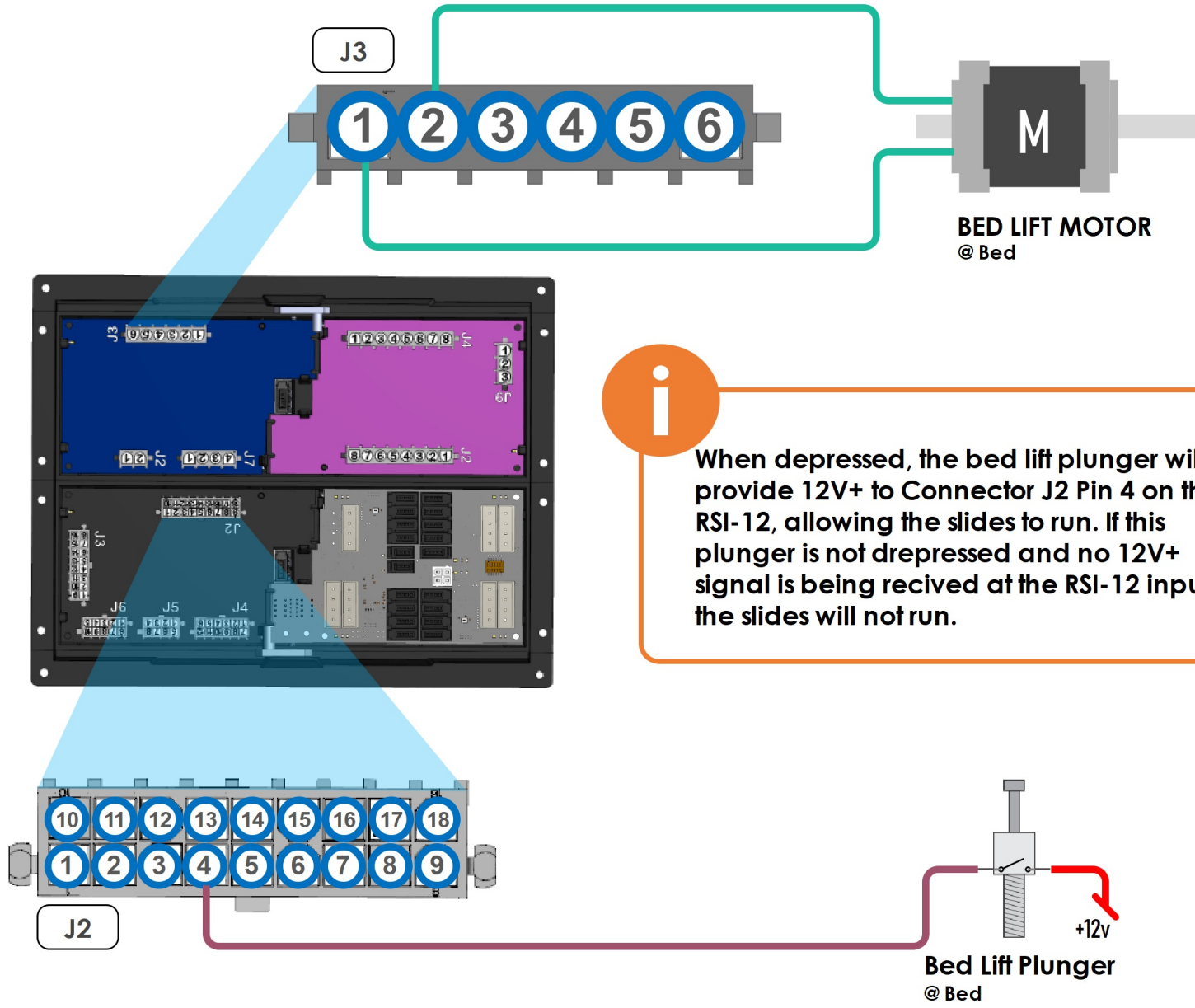

i When depressed, the bed lift plunger will provide 12V+ to Connector J2 Pin 4 on the RSI-12, allowing the slides to run. If this plunger is not depressed and no 12V+ signal is being received at the RSI-12 input, the slides will not run.

Trouble Shooting

This information is only applicable to coaches with a MoRyde TV Lift. The module above is an HCR-15 and is responsible for providing reverse polarity output to the MoRyde TV Lift Motor.

If the TV lift is not raising or lowering check to ensure the NET LED on the HCR-15 is on solid green. If it is flashing or off completely there is an issue with network connectivity. If the module is online (solid green LED) and the TV lift still fails to work, use a multimeter to probe the connector.

Insert one probe into 1A and the other probe into 1B. Correct function would have the module output 12V+ in one direction and ground in the other direction.

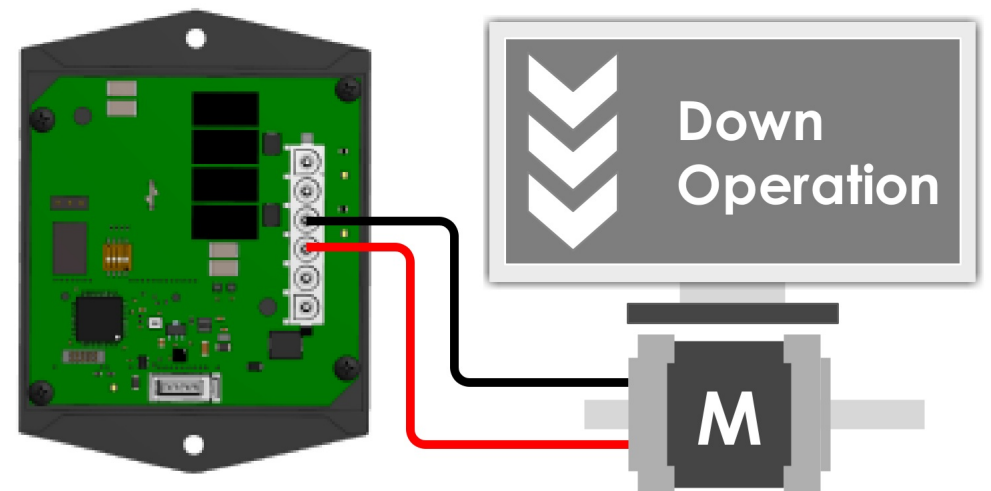
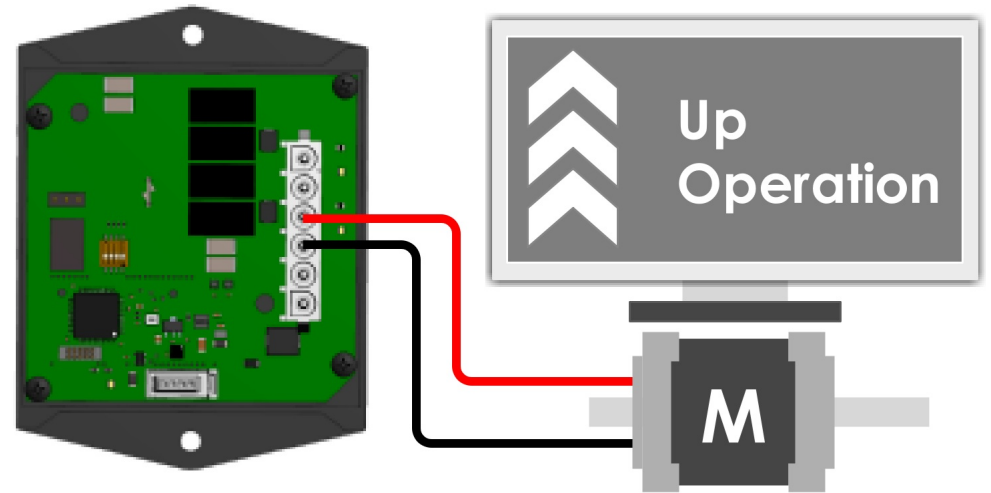
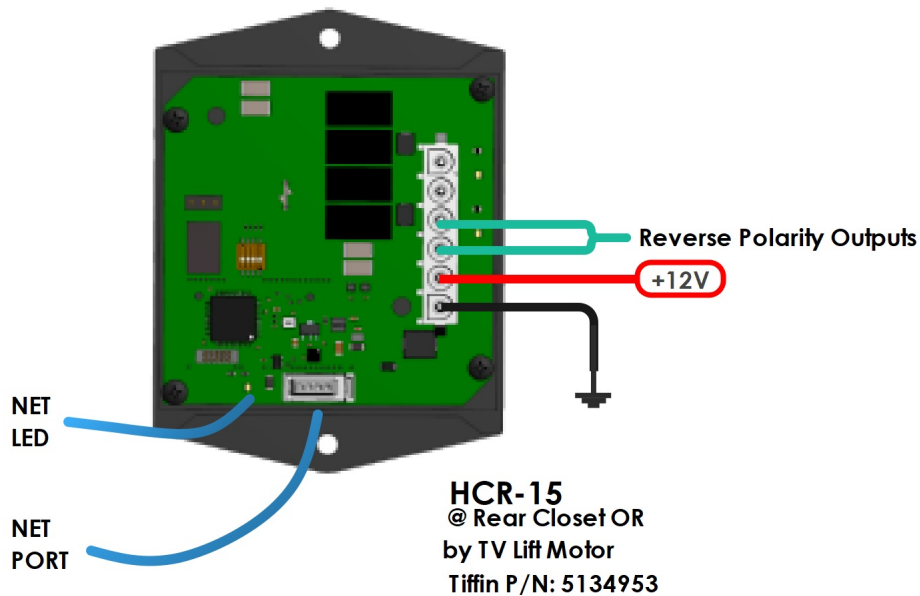

Trouble Shooting

The module below is an HCR-15 and is responsible for providing 12V output to the TV lift motor.

If the TV lift is not raising or lowering check to ensure the NET LED on the HCR-15 is on solid green. If it is flashing or off completely there is an issue with network connectivity. If the module is online (solid green LED) and the TV lift still fails to work, use a multimeter to probe the connector.

To troubleshoot this further, please contact Spyder Controls.

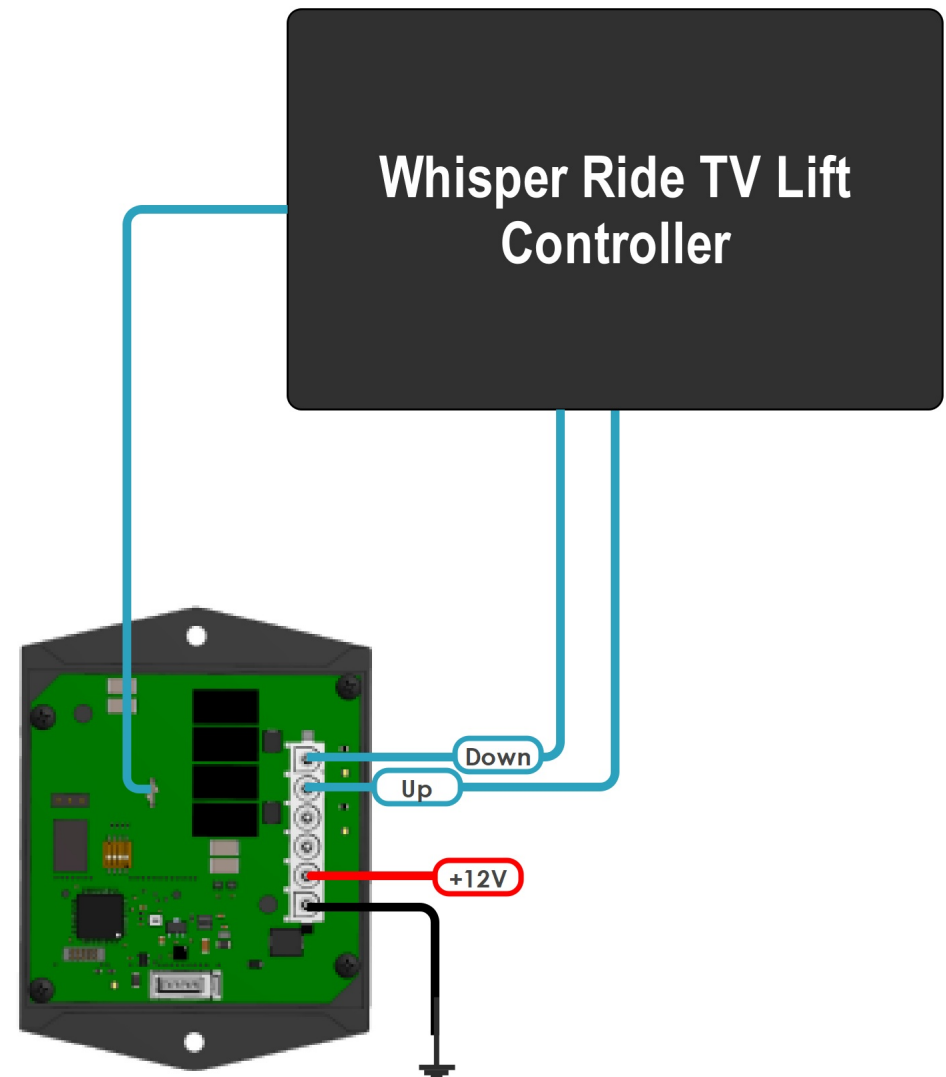
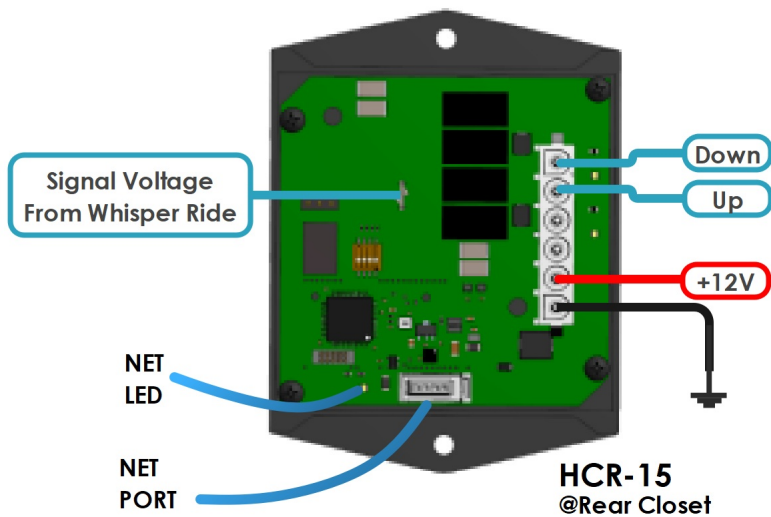

Location Setting

The location setting for the HCR 15 can be changed via connector J5.

Front TV Lift

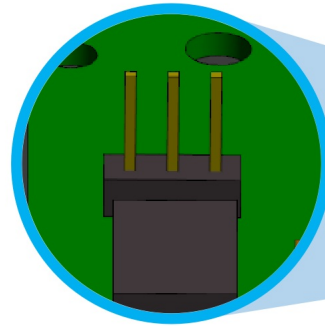

HCR 15

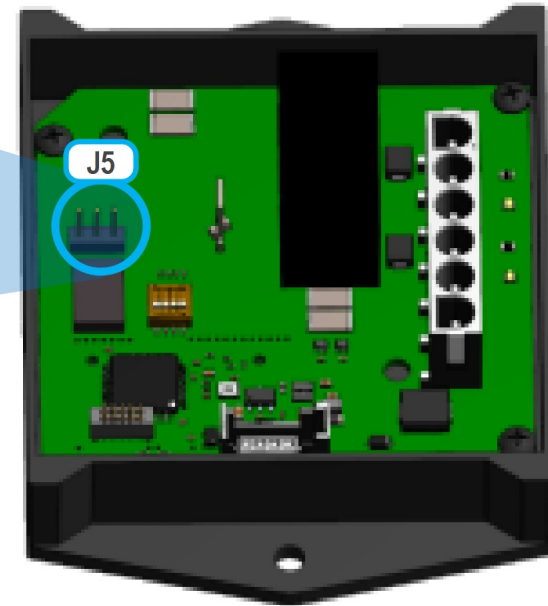

Rear TV Lift

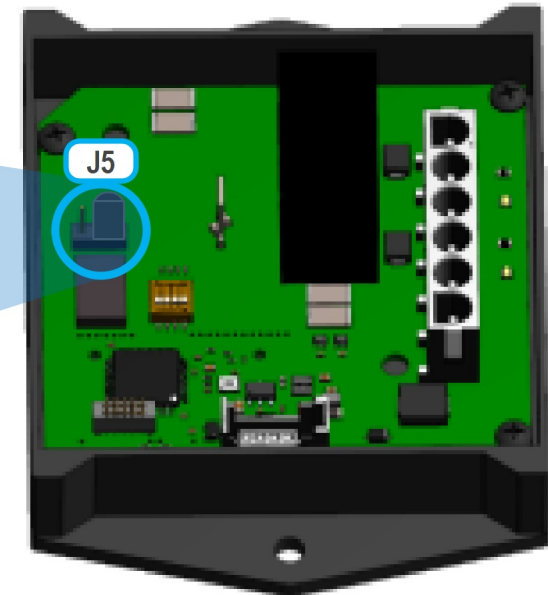
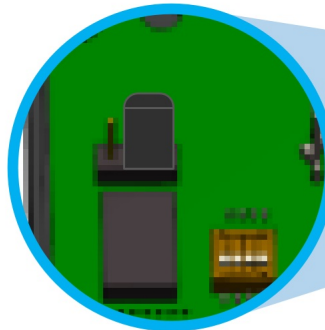

Mid M1 Panel

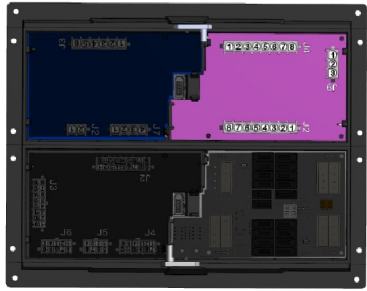

M1 Low Current
@M1 Mid Panel

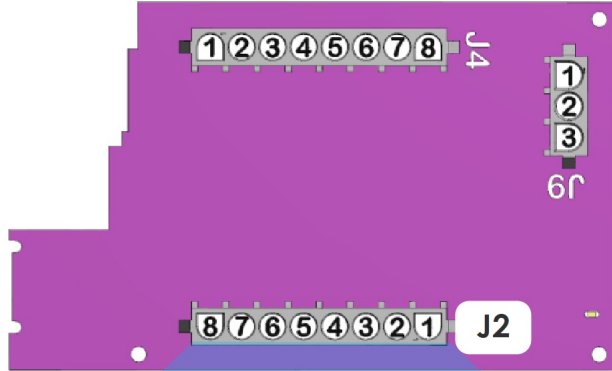

J2 (M1 Low Current)

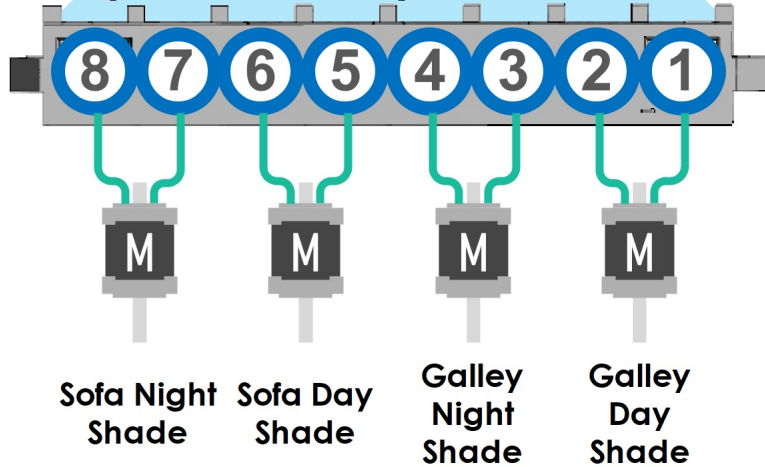

Dash Shade Module

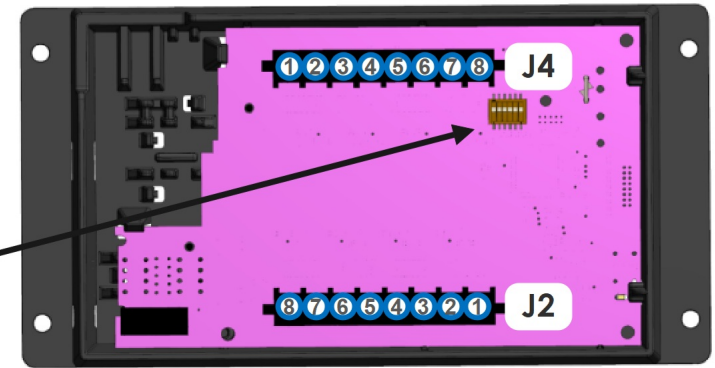

Dip Switch Setting

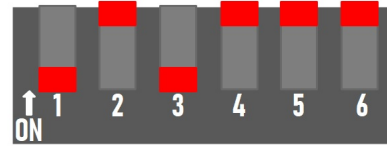

J4

(Shade Module)

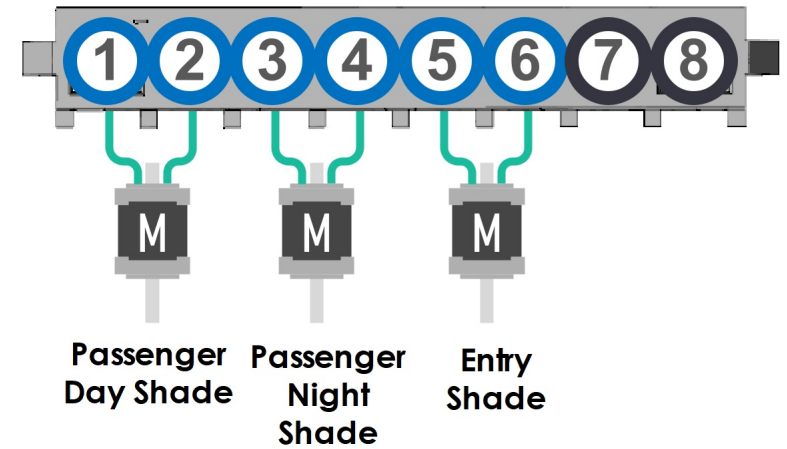

J2

(Shade Module)

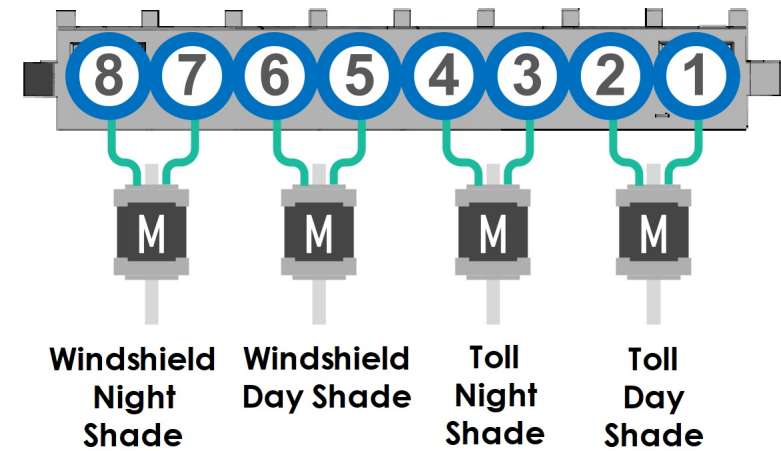

i NOTE
Only momentary operation allowed for lowering shades while ignition is on.

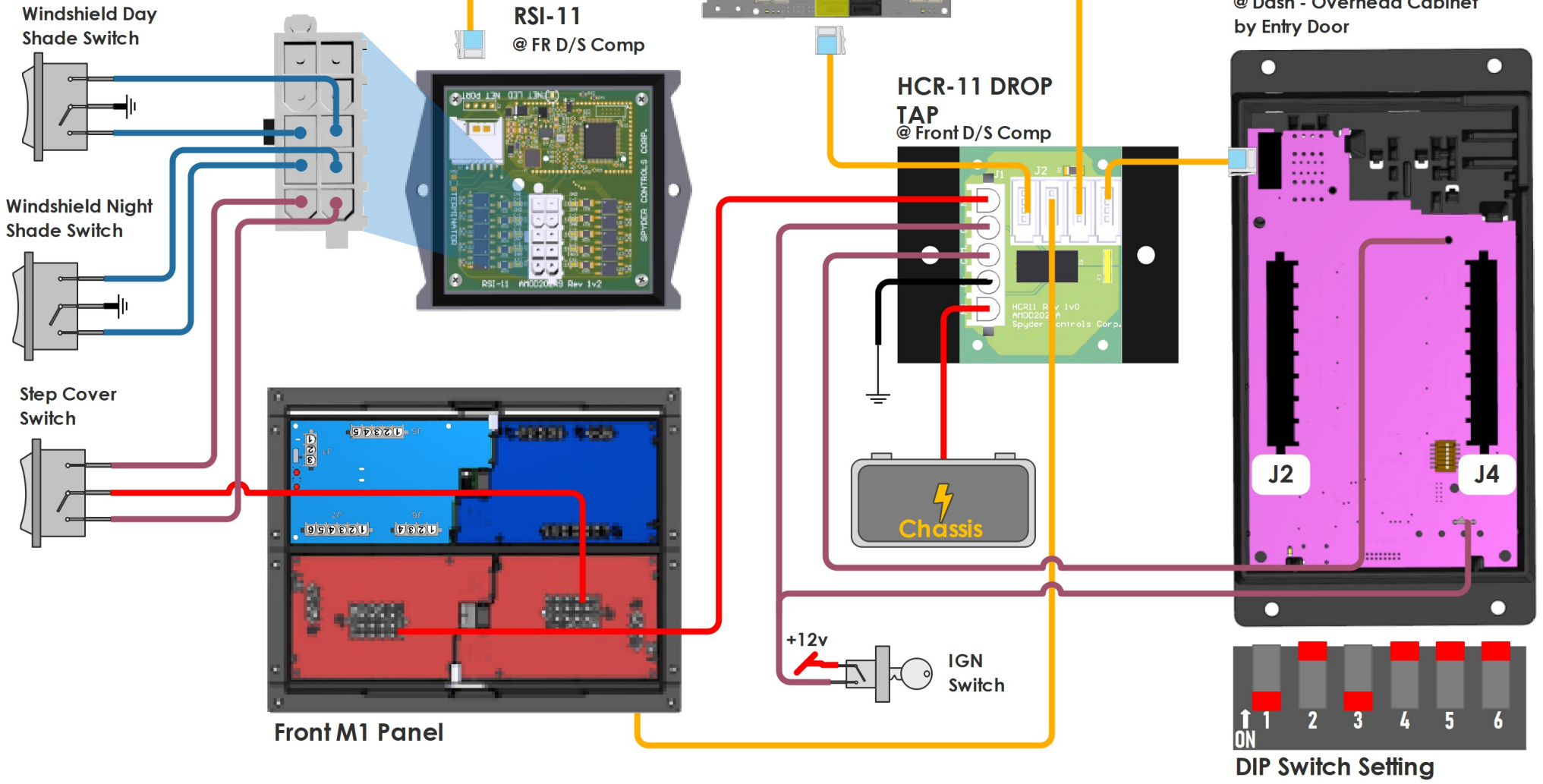

RSI-12
@Mid M1 Panel

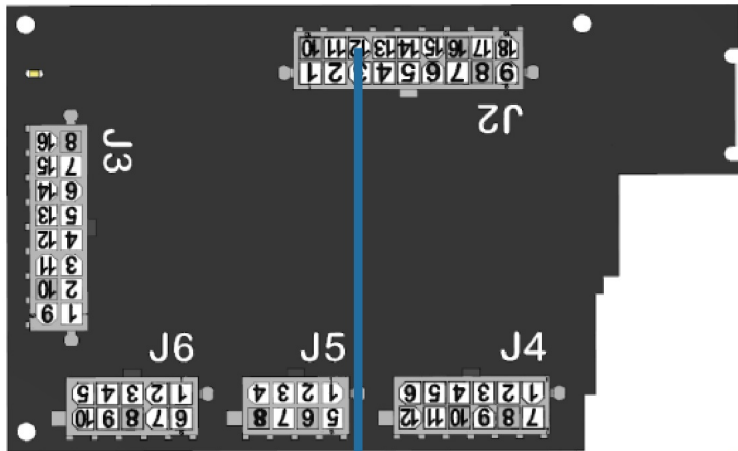

COACH RUNNING INPUT

Depending on the chassis used in the coach the coach running input will either come from the engine (switched GND) or from the ignition (switched 12V+)

The block contains a title, a descriptive paragraph, and two green circular icons: one with an engine symbol and one with a key symbol. A blue line connects the engine icon to the Merge Solenoid, and a red line connects the key icon to the Merge Solenoid.

DCD Panel

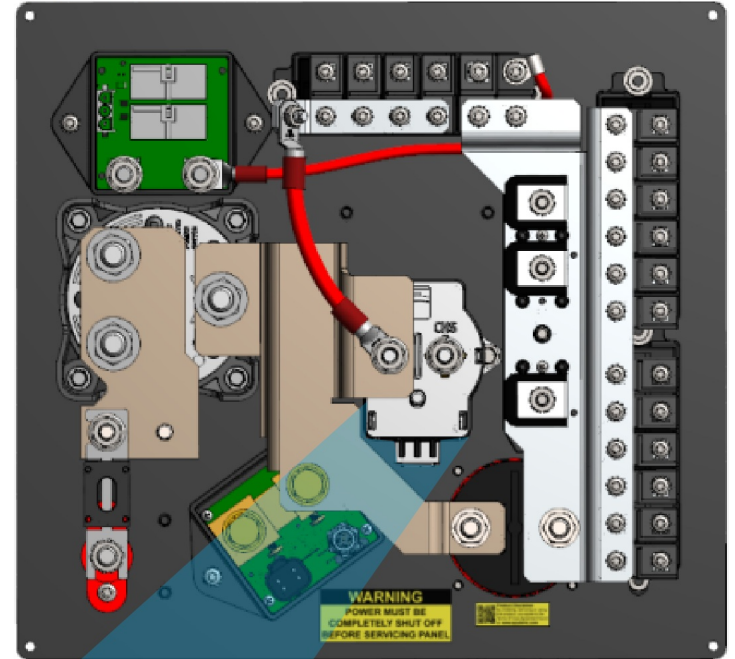

MERGE SOLENOID
@ Back of DCD

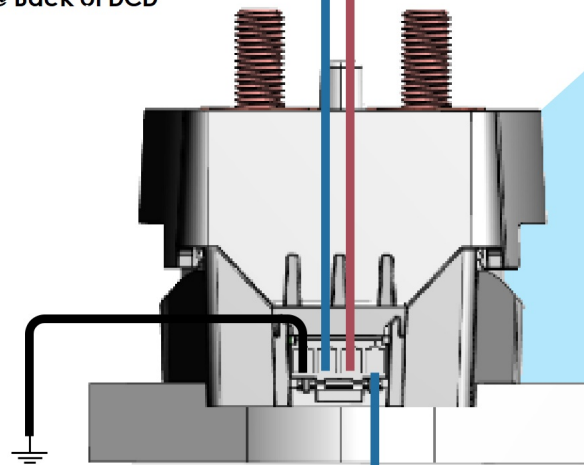

Auto / Manual Merge Input (GND)

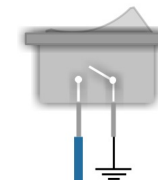

Manual Merge
Override Switch
@ Dash

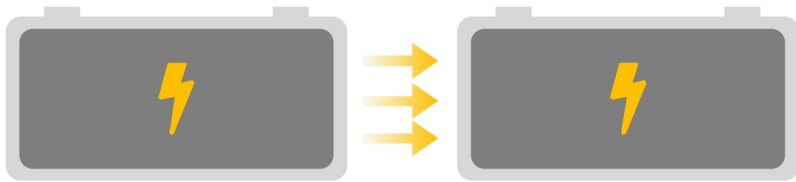
**CHASSIS BATTERY**

⚡ 13.3V+ Or Higher

🕒 30 Seconds

🔑 V+

HOUSE BATTERY**MERGE LOGIC - CHASSIS CHARGING HOUSE**

The merge solenoid will engage if the following conditions are present:

- Engine run or ignition signal is present and chassis voltage is above 13.3V (charging) for 30 seconds.

The merge solenoid will disengage under either of the following conditions

- Engine run or ignition signal is removed
- Chassis voltage drops below 12.6V for more than 30 seconds (unmerge until engine is started again)

**Merge Logic - Note**

The voltages used in this spec are what are read directly at the merge solenoid which is installed at the DCD panel and may vary from the voltages displayed on the LCD screens for general informational purposes

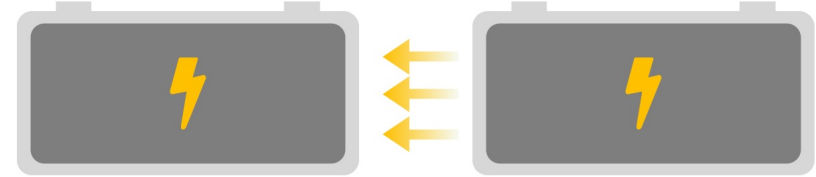
**CHASSIS BATTERY**

⚡ 12.4V+ Or Lower

🕒 30 Seconds

V+

HOUSE BATTERY

⚡ 12.5V+ Or Higher

🕒 30 Seconds

V+

MERGE LOGIC - HOUSE CHARGING CHASSIS

The merge solenoid will engage if the following conditions are present:

- House voltage is above 12.5V (charging) and chassis voltage is below 12.4V (low battery voltage) for 30 seconds

The merge solenoid will disengage under either of the following conditions:

- House voltage drops below 12.2V for more than 30 seconds, OR
- 60 minutes timed battery merge period expires. Re-merge will occur again if the merge conditions are still present

What is EMS?

The EMS or Energy Management System is designed to keep your coach from tripping the shore or generator breaker while using shore or generator power.

How does it work?

The EMS works by allowing or disallowing AC power to specific loads. Keep in mind that not all AC loads are controlled by the EMS. All loads that can be controlled by EMS are displayed in the center column of the Power Page on the main hall LCD. EMS must be enabled to view this page.

What does "SHED" mean?

When EMS has disallowed AC power to a load we consider that load "SHED". This simply means that there currently is not enough AC power available for the load and the EMS will provide power when it is available.

10" Pro LCD



Loads that can "SHED"

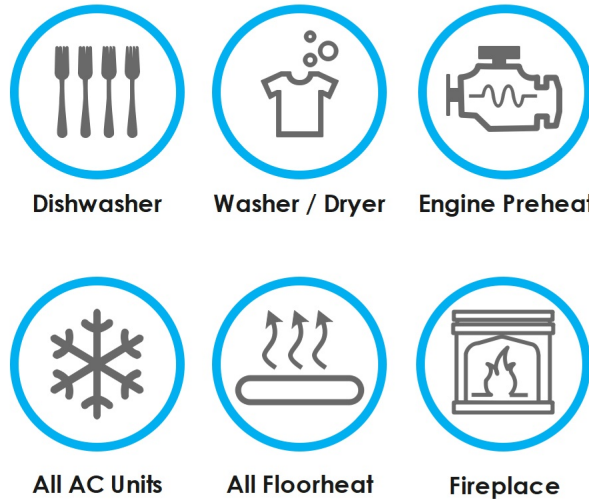

TRC TRANSFER SWITCH

The TRC Transfer switch provides the AC power readings found on the power page.

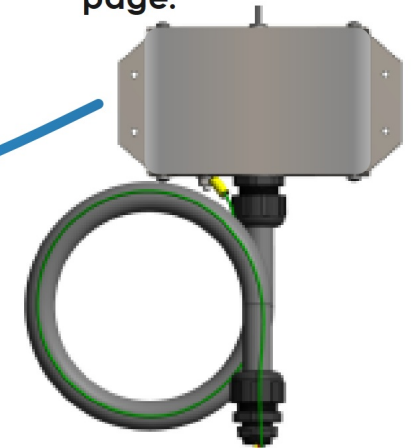

ACR3

The ACR3 allows the EMS to "SHED" the washer/dryer, dishwasher, fireplace and the engine preheat when required.

IF ENABLED INVERTER ASSIST WILL ACTIVATE IF THE FOLLOWING CONDITIONS ARE TRUE

Inverter assist is a state in which power is temporarily drawn from the batteries to keep EMS loads from shedding.

1

SHORE OR GENERATOR POWER IS AVAILIABLE

2

THE CHARGER IS IN FLOAT MODE
(BATTERIES ARE CLOSE TO FULL CHARGE)

3

THE CHARGE RATE HAS BEEN REDUCED

4

A NON-EMS INVERTED LOAD IS ACTIVATED,
SUCH AS THE MICROWAVE

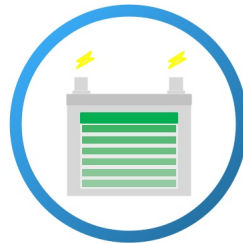

Batteries close to full

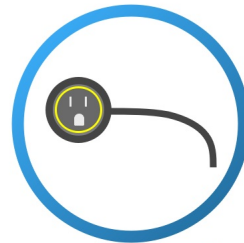

Connected to Shore Power or Gen Charging

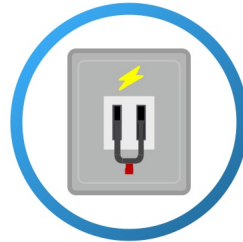

Close to Shore / Gen Breaker Max

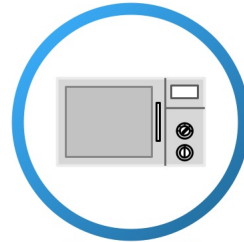

Non-EMS Inverted Load Activated

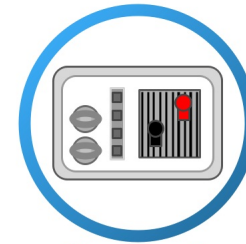

Charger in Float

=



!

If the conditions above are true. To keep any EMS load from shedding the inverter will go from passthrough to inverting to temporarily invert for 5 minutes. Please note inverter assist will temporarily decrease your battery voltage. This is normal the voltage will stabilize relatively quickly once the inveter assist period has expired. Please note inverter assist can only occur once every charge cycle. Therefore, the coach will not frequently be in inverter assist mode.

!

Inverter assist can be enabled or disabled from the inverter settings page. On you main LCD navigate to the power page > inverter settings > advanced battery settings > inverter assist.

To Replace The Battery

To replace the battery firmly grasp the outside edge of the wireless rocker switch. Pull to the left or right until the switch snaps off the wall. Use a pen or other thin object to push the coin cell out of the retaining clip. Insert new battery with the + symbol facing upwards, ensure battery is seated into retaining clip all the way.

Use the up arrows on the back of the switch panel to orientate placement back onto the mounting bracket. Snap the wireless rocker switch back into place.

Test the switch and dispose of the old battery responsibly.

WARNING

ONLY REPLACE THE COIN CELL BATTERY WITH A CR2032. DOING OTHERWISE WILL VOID THE PANEL WARRANTY AND COULD DAMAGE THE PANEL



Insert Battery with + sign facing up.

Snaps on and off wall bracket

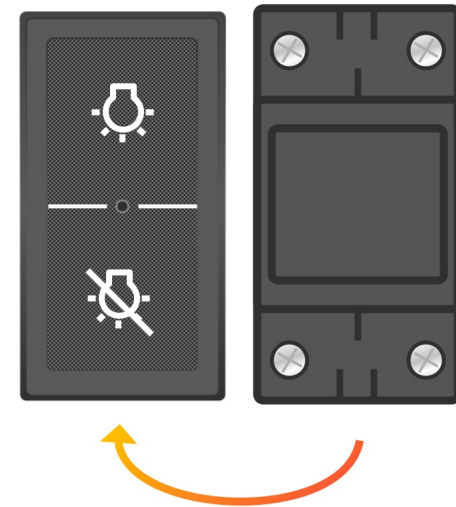

A green LED will turn on when a button is pressed. This is the transmit LED and confirms that the switch panel is transmitting information. This LED will flash occasionally indicating the switch panel is transmitting its battery status.

Not Transmitting

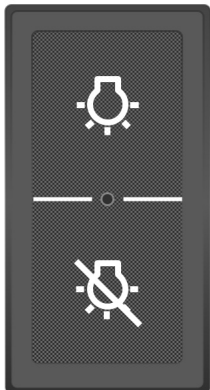

Transmitting

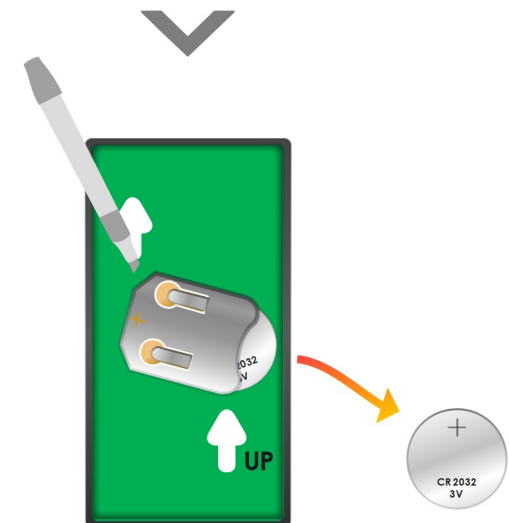
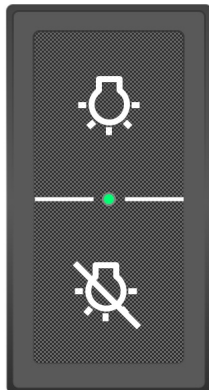

Mid M1 Panel

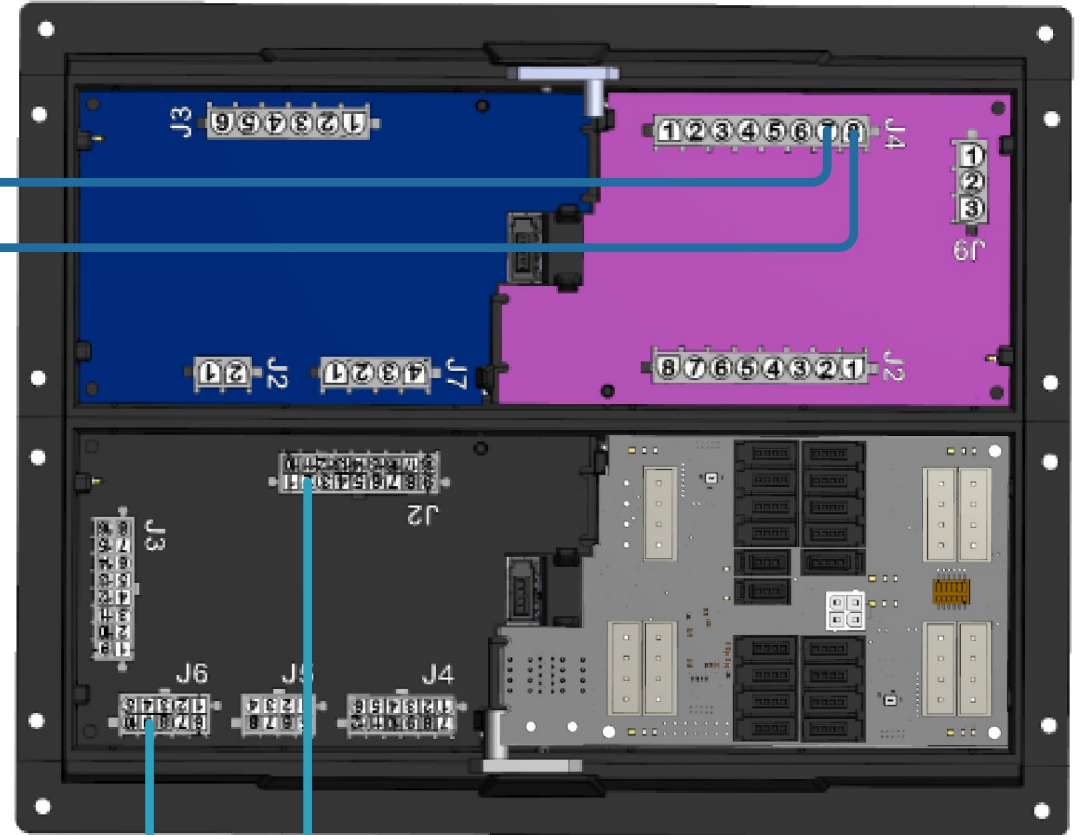

Generator

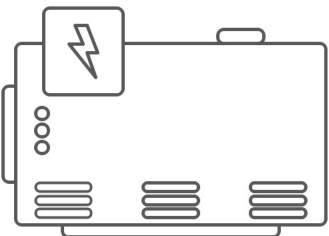

- Gen Start (GND)
- Gen Stop (GND)
- Gen Run Signal (+12v)
- Gen Fault Status (+12v)

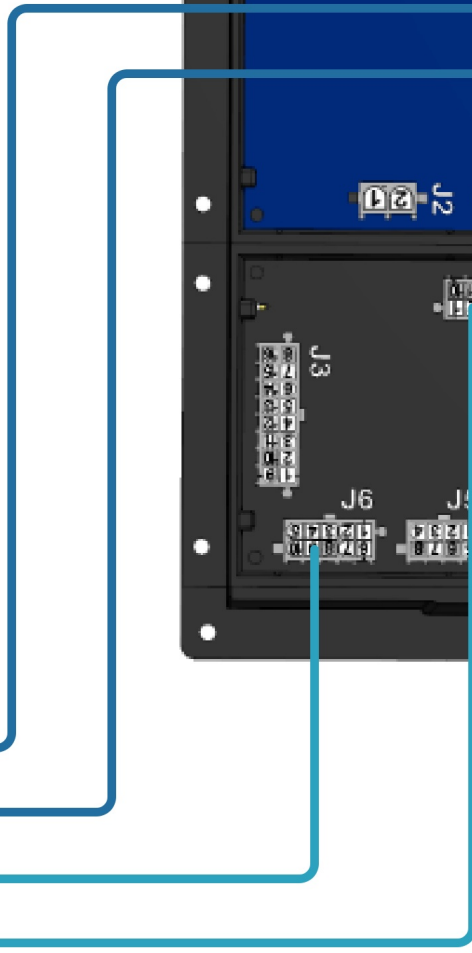

Front M1 Panel

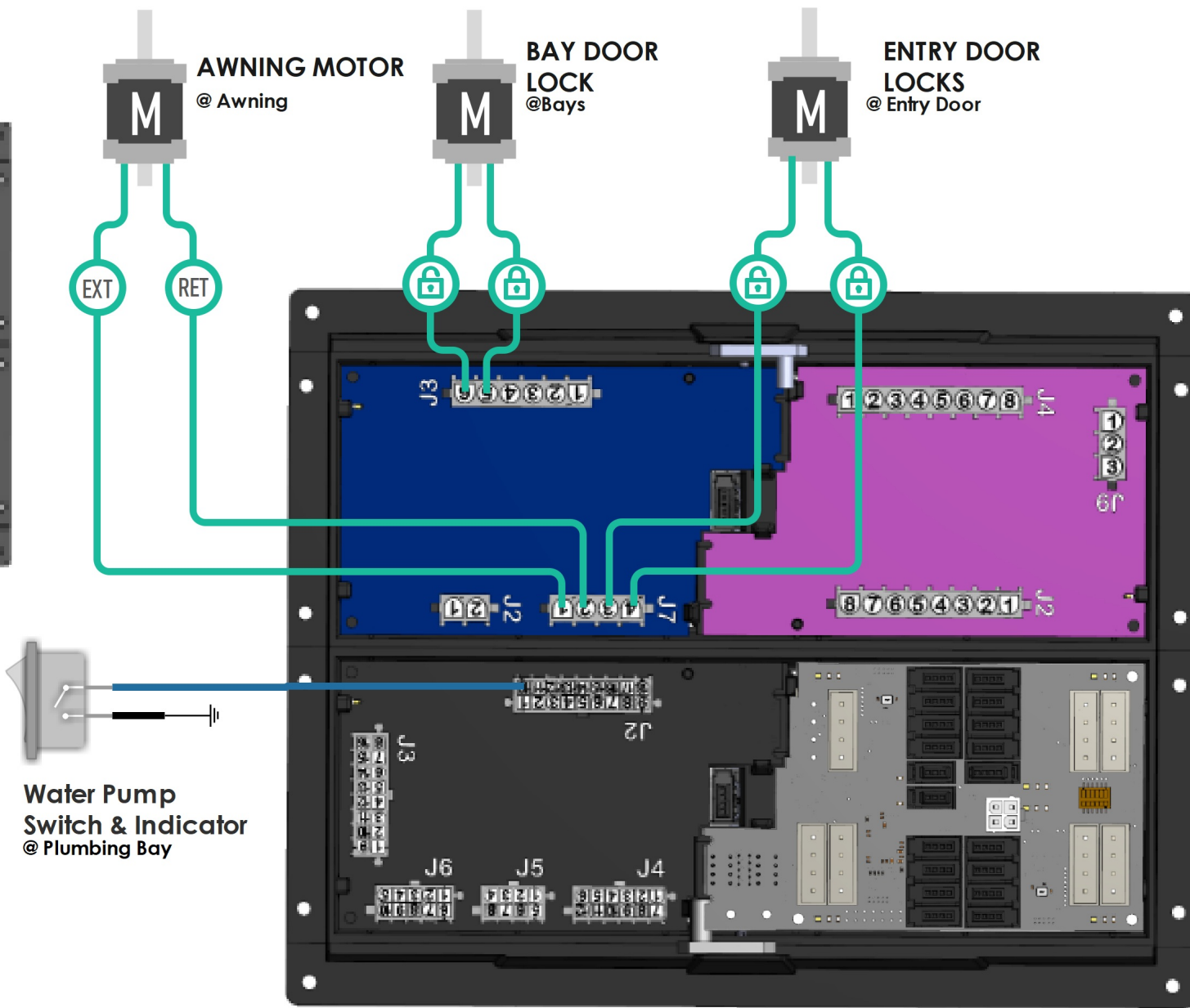
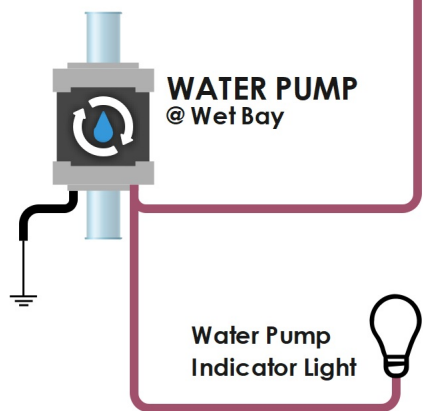
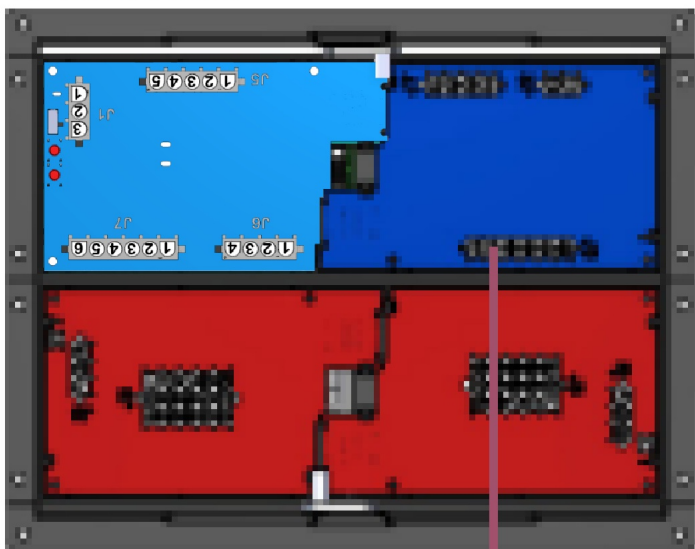

Mid M1 Panel

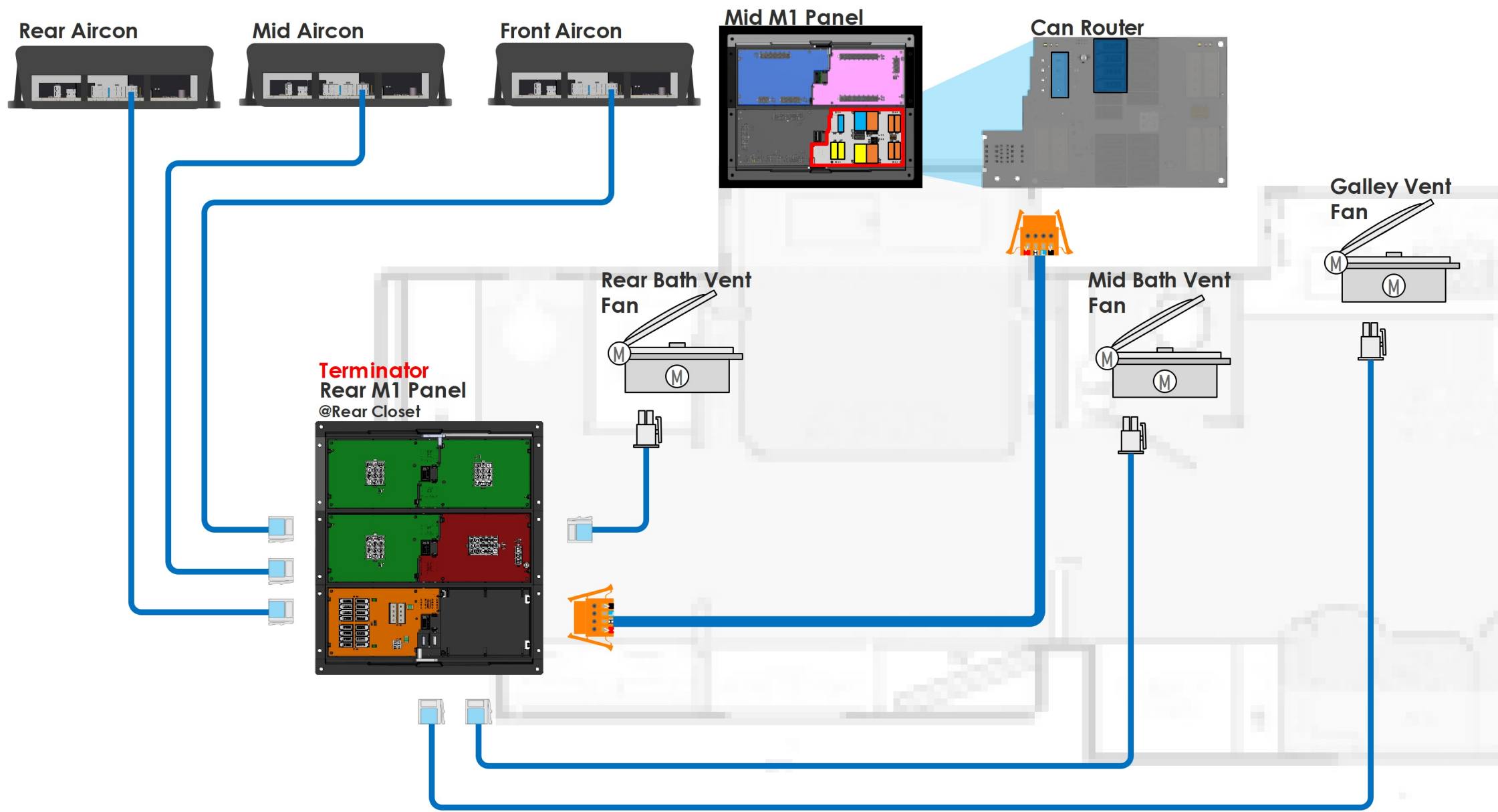

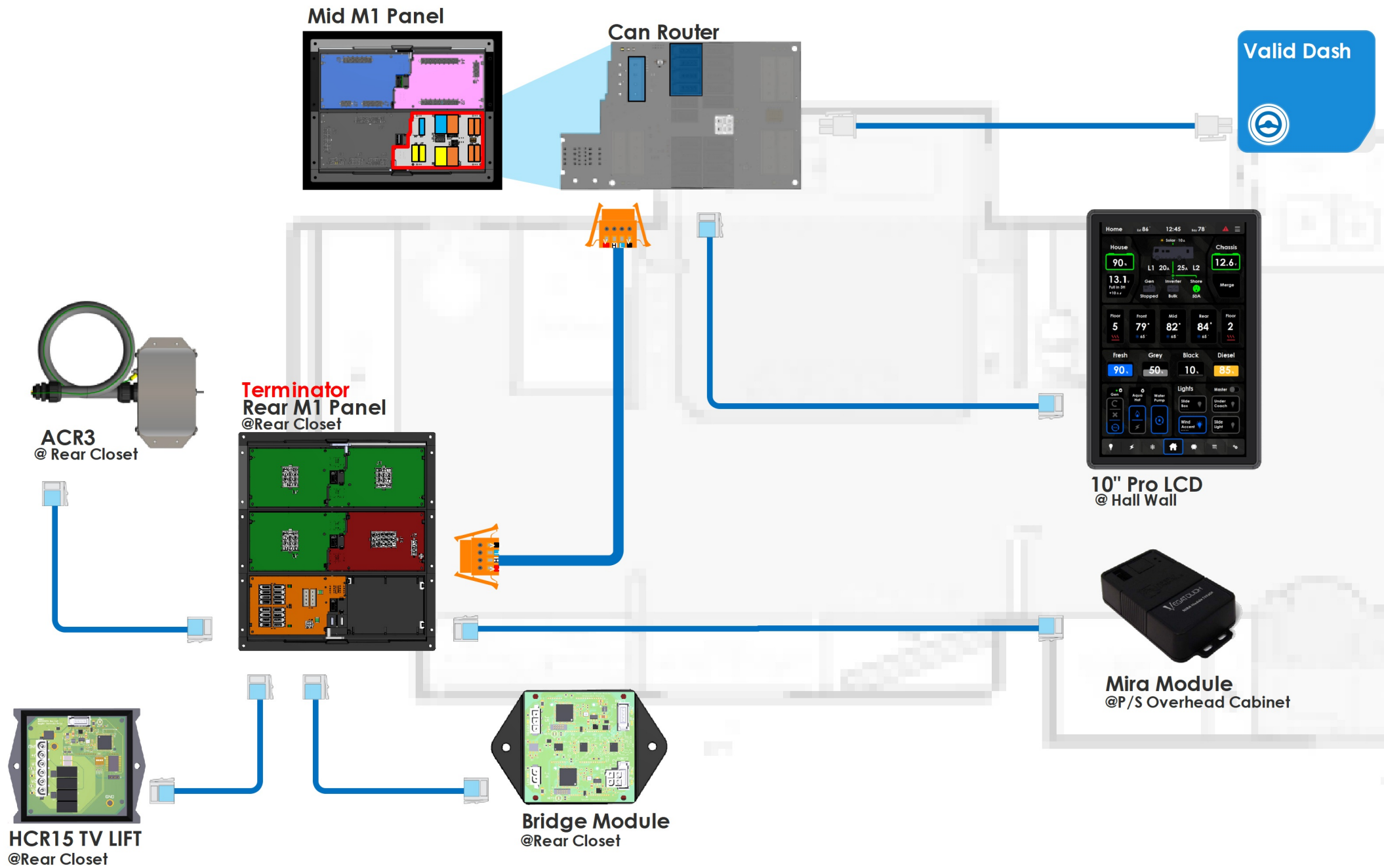

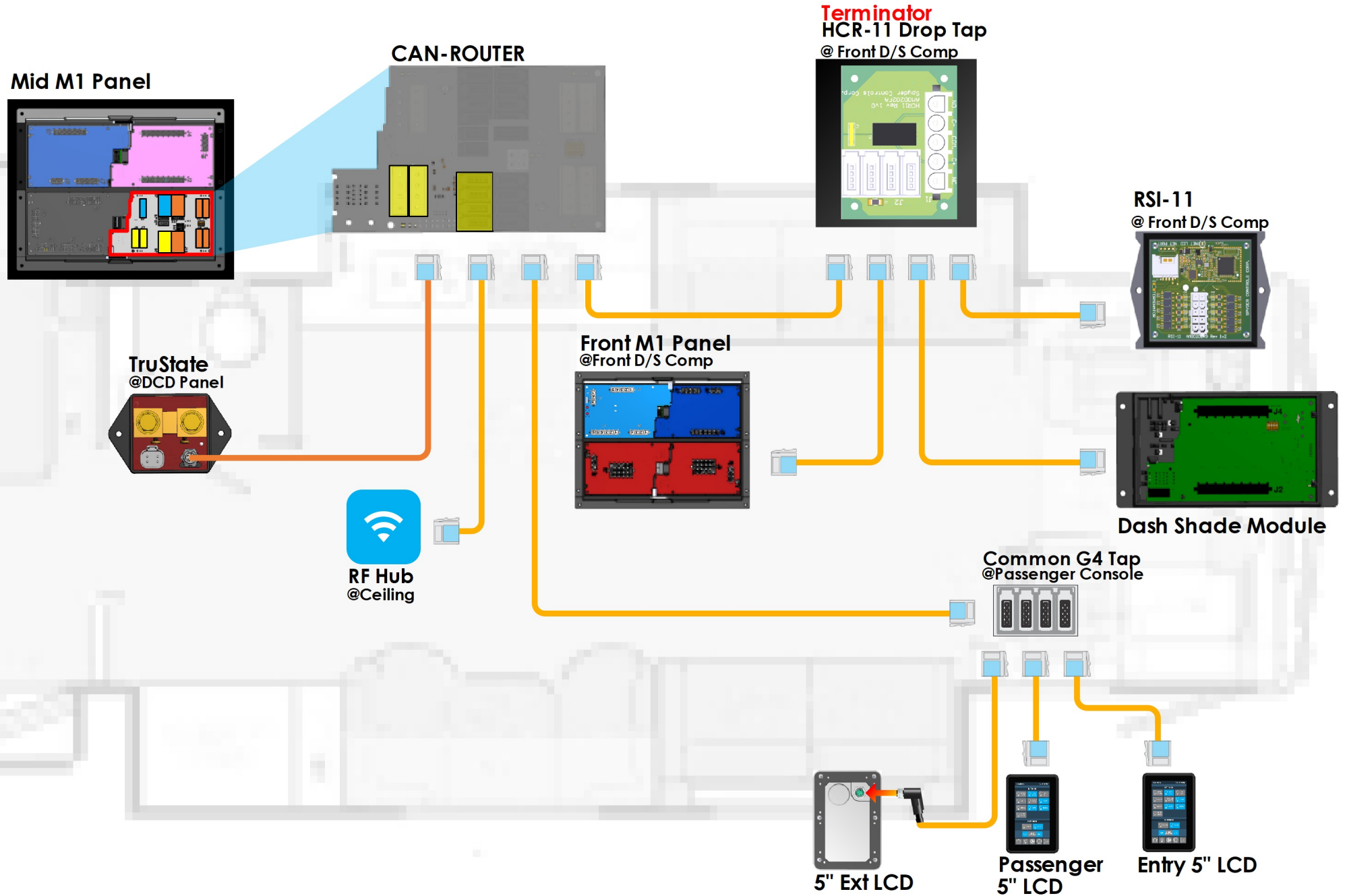

Mid M1 Panel

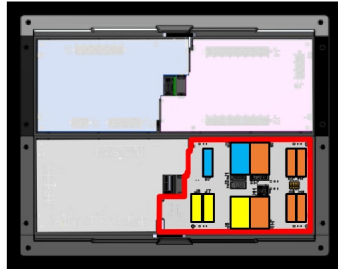

Can Router



Rear Bath
3.5" LCD

Galley 3.5"
LCD

Mid Bath 3.5"
LCD

G4 Terminator
@ Under Dinette

Front Shade Module
(Bus Only)

Dinette 3.5"
LCD

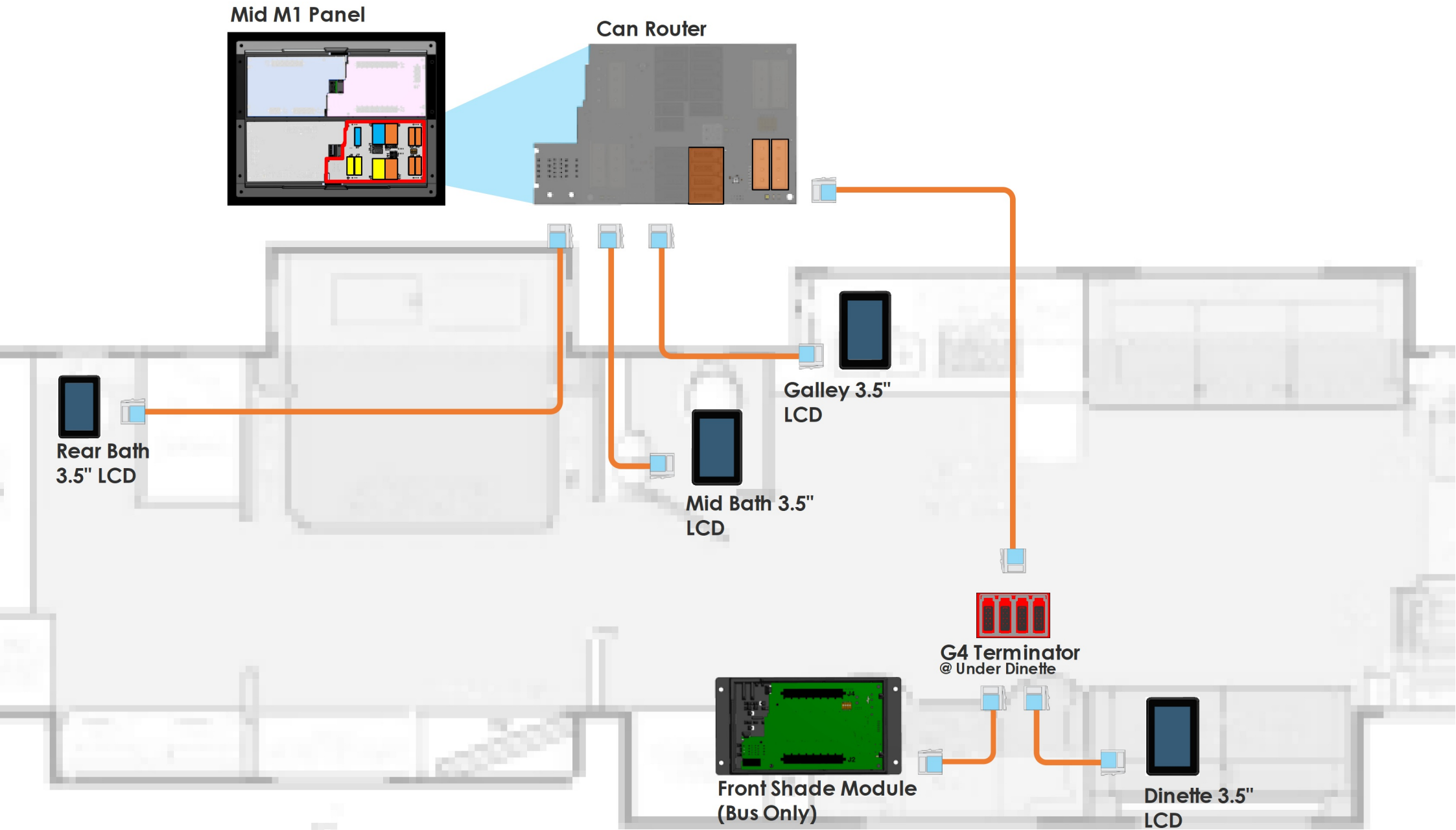

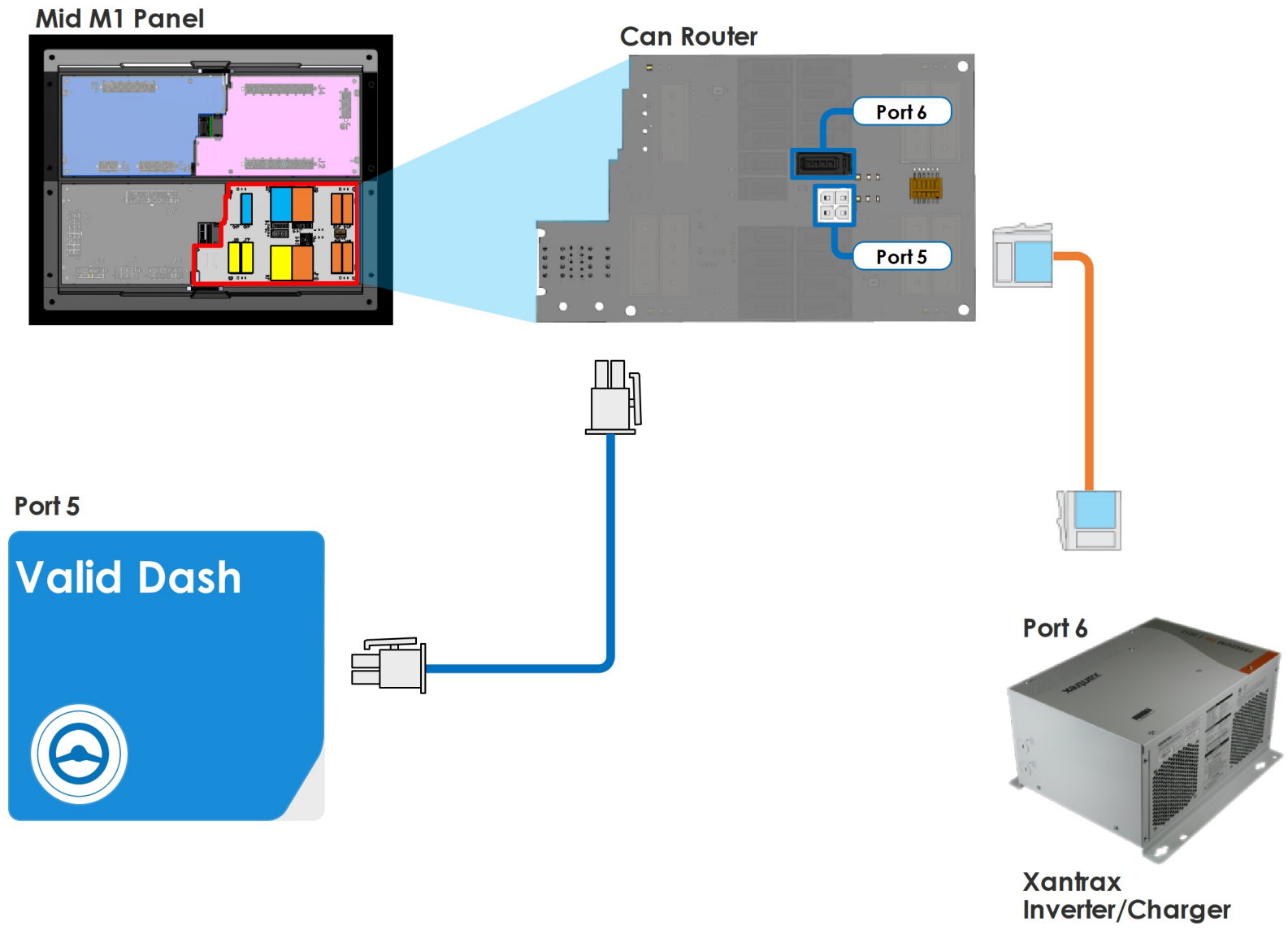

THE ORDER OF THE NETWORK CABLES AT THIS TAP IS IMPORTANT !

The M1 Shade Standalone and RSI-11 MUST be plugged into the ports shown. The always on ports are powered when the house disconnect is off.

Tiffin P/N: 5105426
Terminator
HCR-11 Drop Tap
@ Front D/S Comp

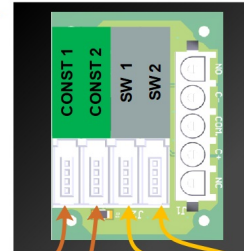

Always On Network
This network to remain powered while house disconnect is off.

Always On Switched



RSI-11
@ Front D/S Comp
Tiffin P/N: 5127304

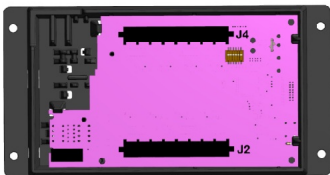

Dash Shade Module
Tiffin P/N: 5127302



RF Hub
Tiffin P/N: 5127293

Front M1 Panel
@Front D/S Comp

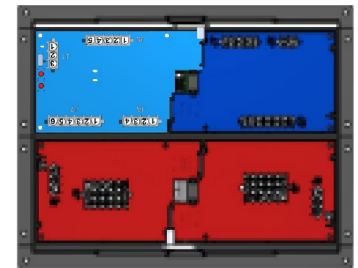

Mid M1 Panel
Tiffin P/N: 5127299

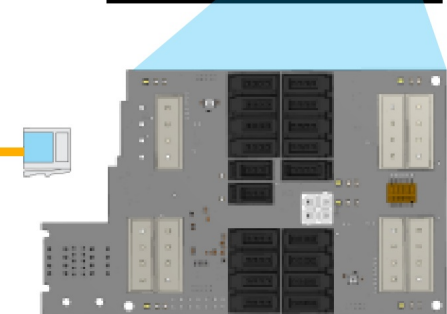

Can Router

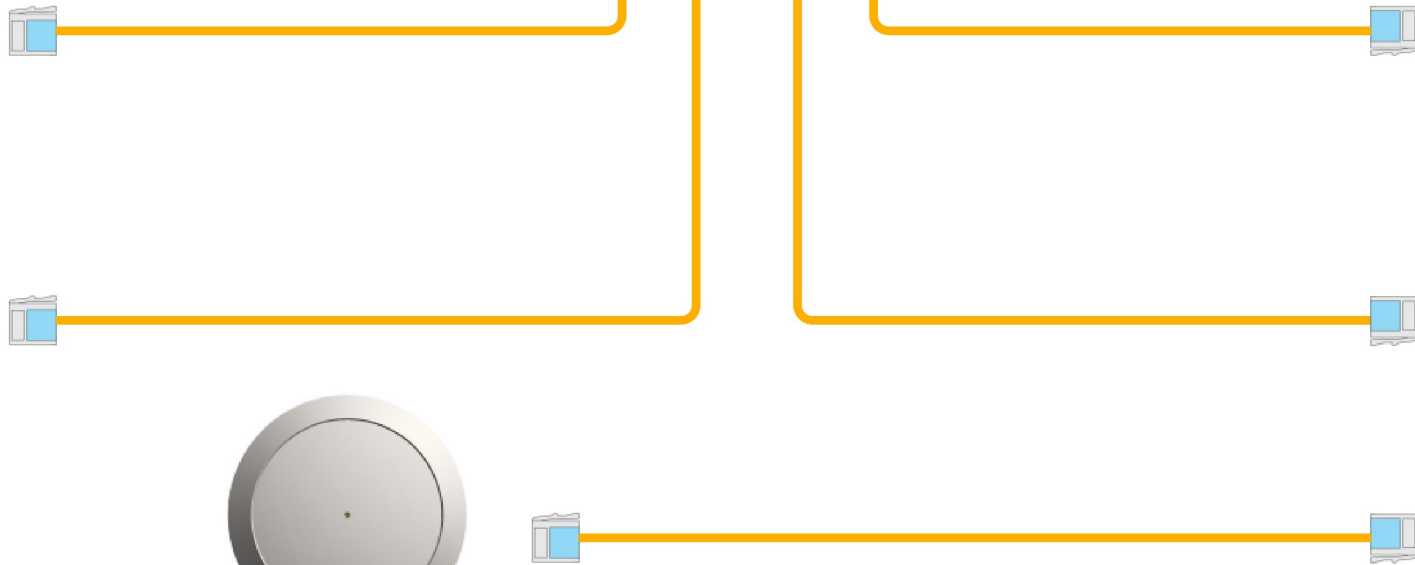

BDC 3

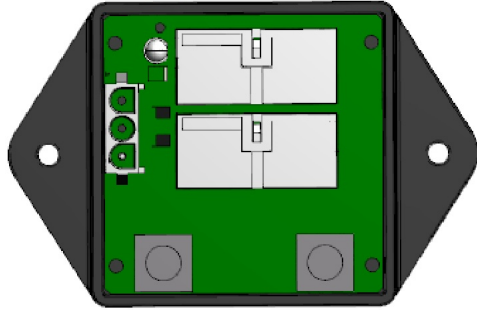

J1	
Pin	Description
3	COIL SET Input
2	COIL RESET Input
1	SWITCH SUPPLY (+12V) Output

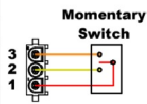

*Coil should not be powered for more than 10 sec

DCD Panel

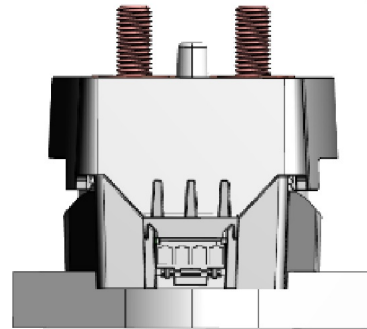
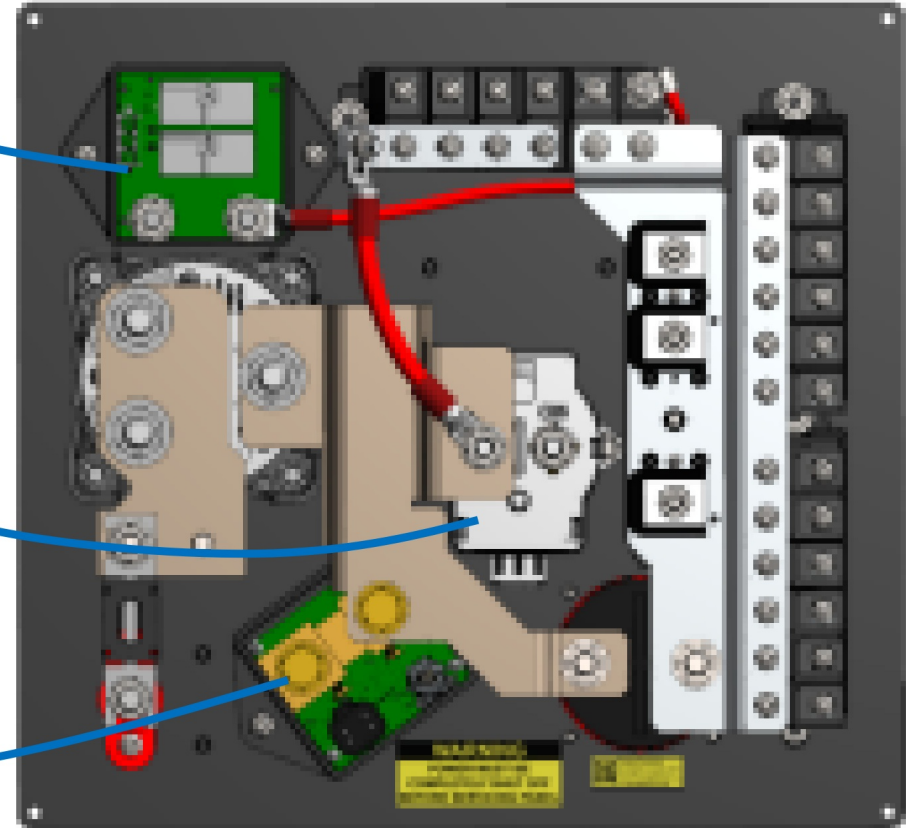

MergeMan

TruState

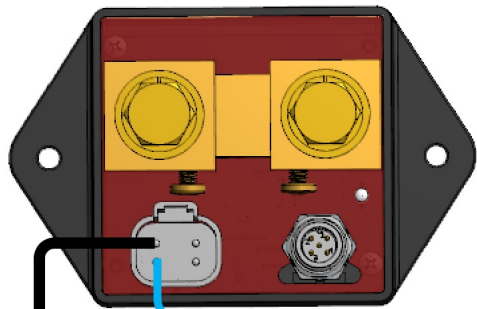

(GND)

Chassis voltage input (+12v)

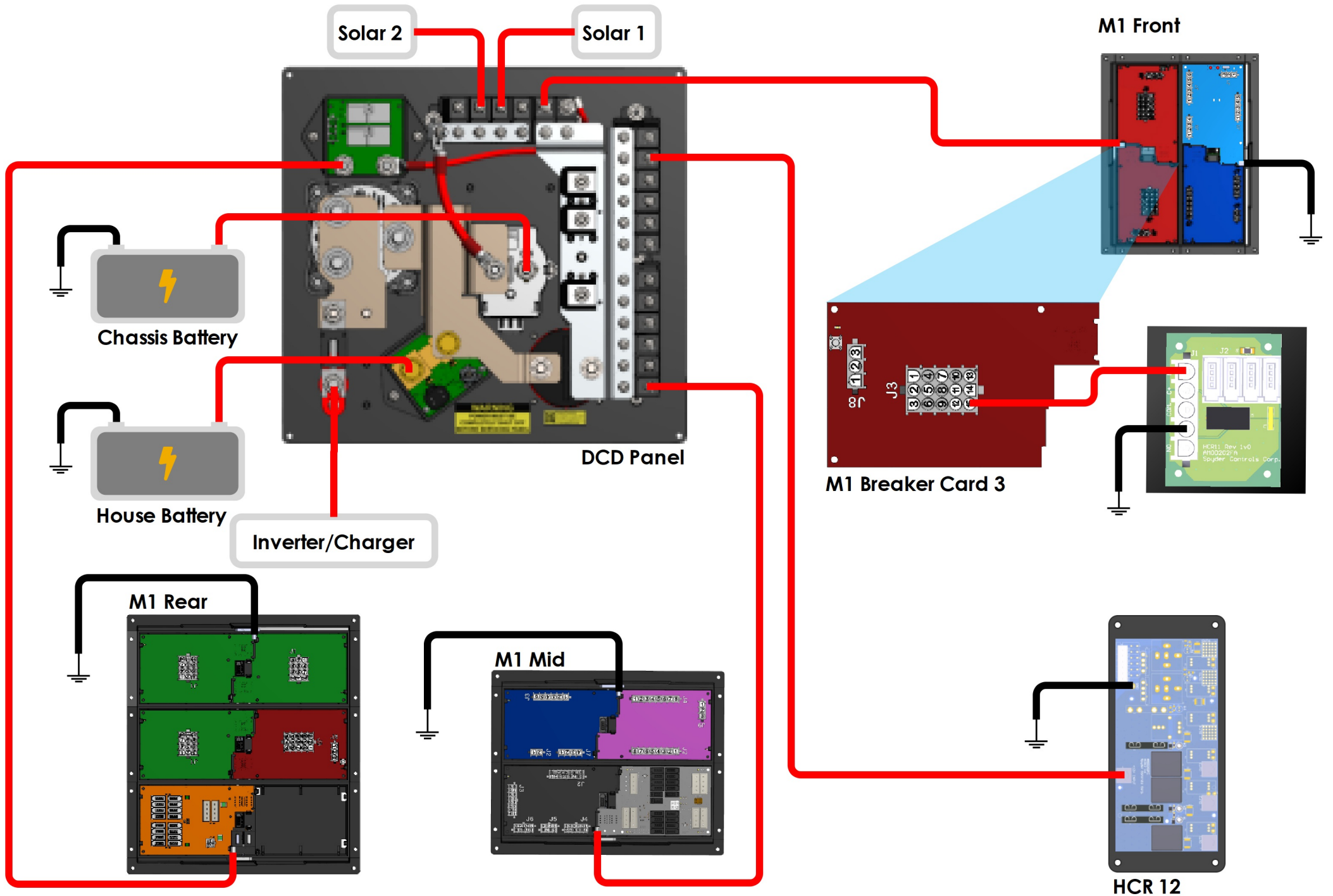

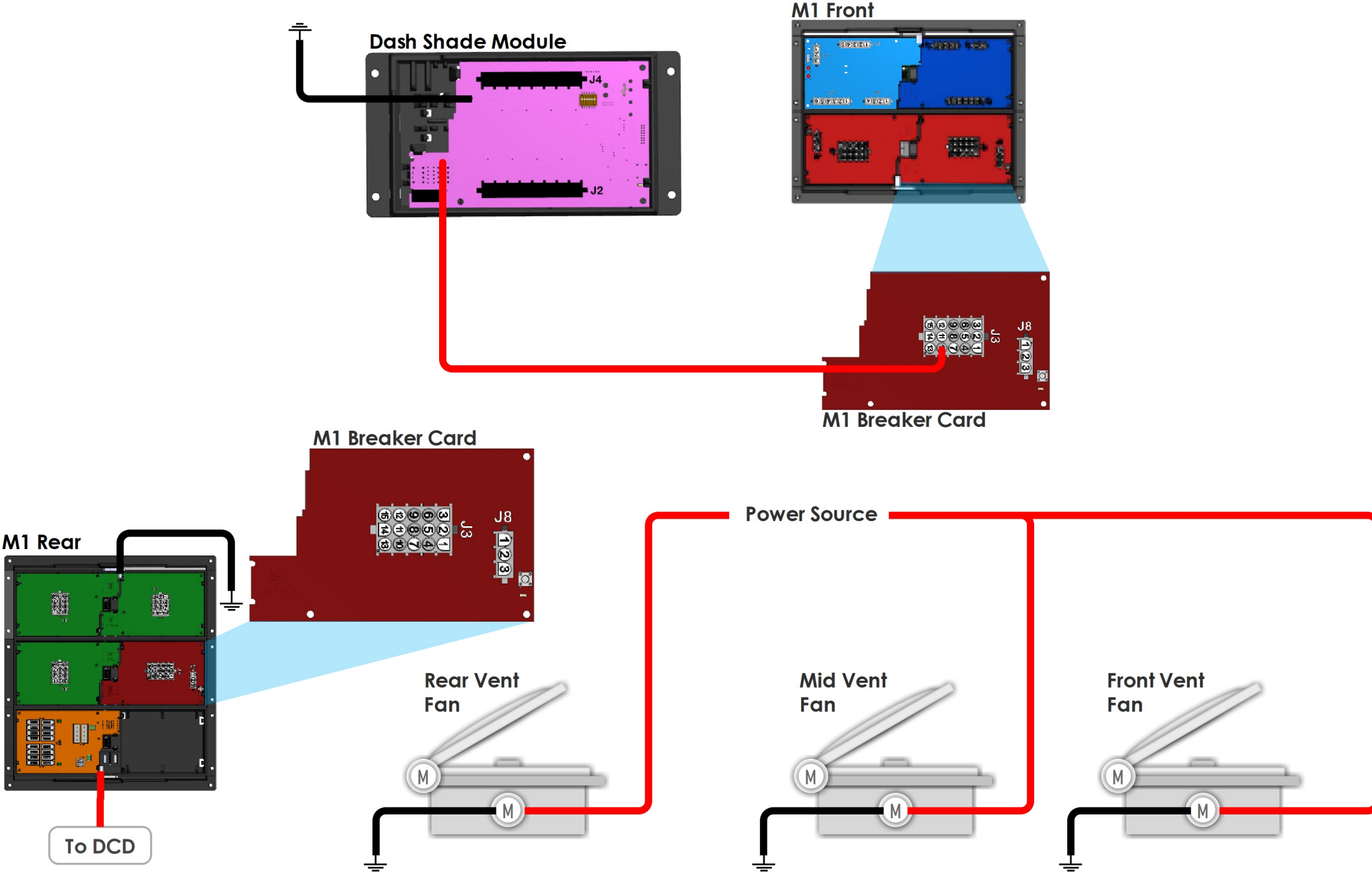

TERMINATOR
HCR-11
 Tiffin P/N: 5105426

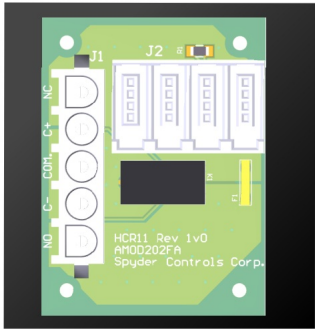

G4 Common Drop Tap
 Tiffin P/N: 5016592

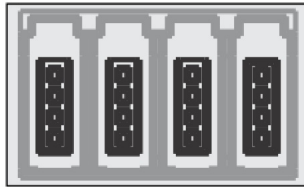

G4 Terminator Drop Tap
 Tiffin P/N: 5051936



Mini-Clamp Plug
 Tiffin P/N: 5066157
 3M P/N: 37104-2165-000 FL 100



Mini-Clamp Socket
 Tiffin P/N: 5066158
 3M P/N: 37304-2165-000 FL 100



Wago Hook Tool
 Wago P/N: 231-131



4 Pos Wago Connector
 Tiffin P/N: 5015508
 MFP/N: 231-304/037-000

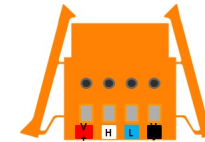

MiniFit Jr Connector
 Digi-Key P/N: 0039012040



Minifit Jr Pins
 Digi-Key P/N: 0039000181

