

Go The Adventure Starts Now Explore Find Out Live Free

# 2024/2025

## Tiffin Wayfarer

Integration Schematic



**SPYDER**  
CONTROLS CORP

# Table of Contents









Integration Schematic Release: 1.1

Release Date: January 4, 2024

- 1** Module Locations
- 2** G12 Pinout
- 3** G12 Pinout Continued
- 4** Interior Lighting
- 5** Maxxfans
- 6** Screens & Switches
- 7** Slides

- 8** Tank Sensing
- 9** LP Tank Sensing
- 10** Mechanical
- 11** Connectors

## Schematic Connections Legend

-  Constant Ground
-  Constant 12V+
-  Switched Ground
-  Switched 12V+
-  Reverse Polarity
-  Signal
-  120V AC Line
-  Network

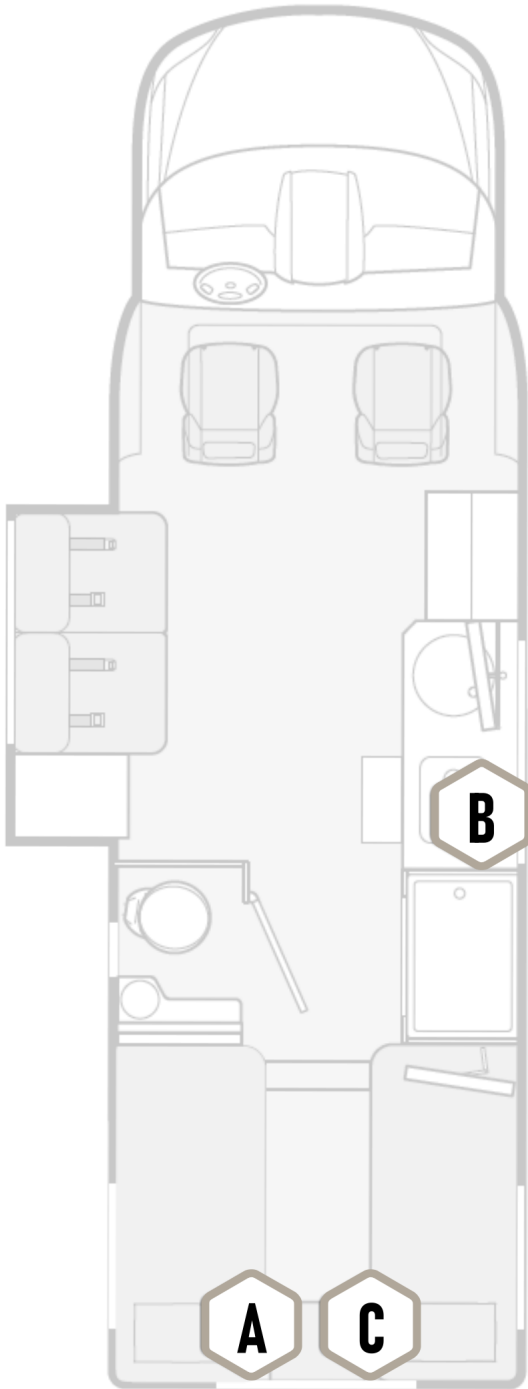

**A**

**G12 Module**

Spyder Part Number  
BMODZU2VG

Foot Of The Bed

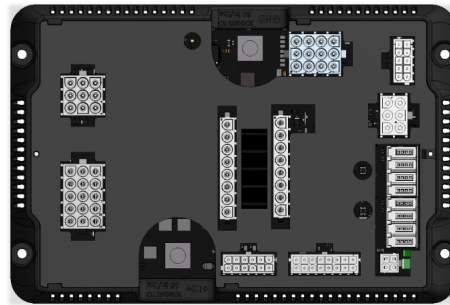

**B**

**7" Lite LCD**

Spyder Part Number  
BSSPZZQDZ

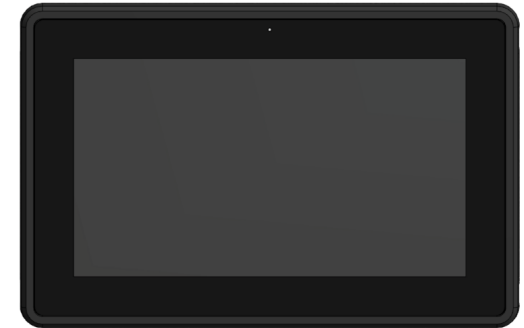

**C**

**Mira Module**

Spyder Part Number  
BMODZ56VF



## J4

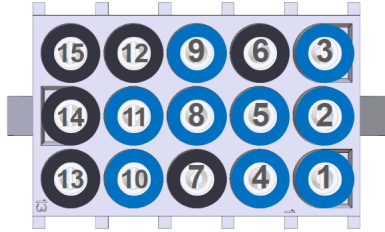

- |                         |                         |
|-------------------------|-------------------------|
| ① Hall Lights (CH30)    | ⑨ Sofa Slide RET (CH38) |
| ② Entry Light (CH31)    | ⑩ Bed Slide EXT (CH39)  |
| ③ Porch Light (CH32)    | ⑪ Bed Slide RET (CH40)  |
| ④ Awning Light (CH33)   | ⑫ Spare                 |
| ⑤ Cargo Light (CH34)    | ⑬ Spare                 |
| ⑥ Spare                 | ⑭ Spare                 |
| ⑦ Spare                 | ⑮ Spare                 |
| ⑧ Sofa Slide EXT (CH37) |                         |

## J3

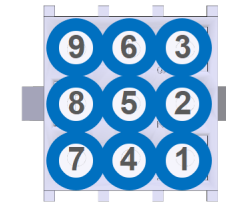

- |                           |                |
|---------------------------|----------------|
| ① Main O/H/Living Room Lt | ⑥ Bathroom Lt  |
| ② Sofa Reading Lt         | ⑦ Shower Lt    |
| ③ Bedroom Lt              | ⑧ Front Accent |
| ④ Bed Reading Lt          | ⑨ Task Lt      |
| ⑤ Bed Slide/ Cabinet Acnt |                |

## J11

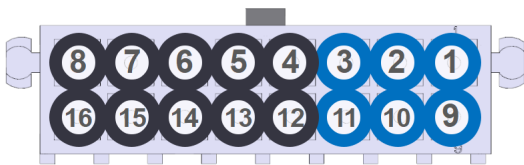

- |                           |                   |
|---------------------------|-------------------|
| ① Fresh Tank Sensor Input | ⑨ Tank Sensor GND |
| ② Grey Tank Sensor Input  | ⑩ Tank Sensor GND |
| ③ Black Tank Sensor Input | ⑪ Tank Sensor GND |
| ④ Spare                   | ⑫ Spare           |
| ⑤ Spare                   | ⑬ Spare           |
| ⑥ Spare                   | ⑭ Spare           |
| ⑦ Spare                   | ⑮ Spare           |
| ⑧ Spare                   | ⑯ Spare           |

## J5

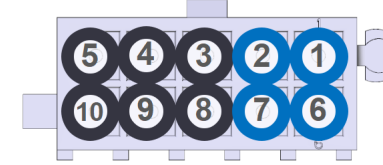

- |                    |                              |
|--------------------|------------------------------|
| ① Water Pump (GND) | ⑥ Water Heater Status (+12V) |
| ② Park Brake (GND) | ⑦ Ignition (+12V)            |
| ③ Spare (GND)      | ⑧ Spare (+12V)               |
| ④ Spare (GND)      | ⑨ Spare (+12V)               |
| ⑤ Spare (GND)      | ⑩ Spare (+12V)               |

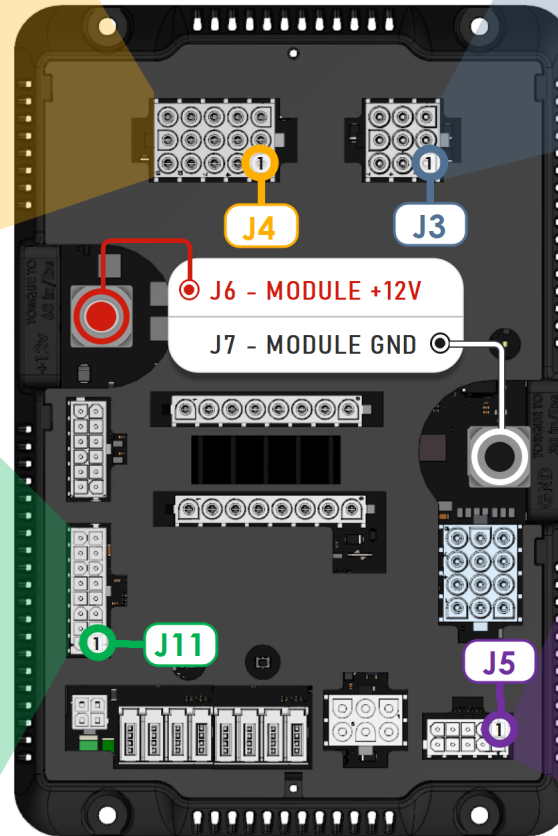

**G12 Module**  
@ Under Bed

## J8



- |                       |         |
|-----------------------|---------|
| 1 Water Pump (CH1)    | 5 Spare |
| 2 Tank Heat 1&2 (CH2) | 6 Spare |
| 3 Bed Lift Up (CH3)   | 7 Spare |
| 4 Bed Lift Down (CH4) | 8 Spare |

## G12 Module @ Under Bed

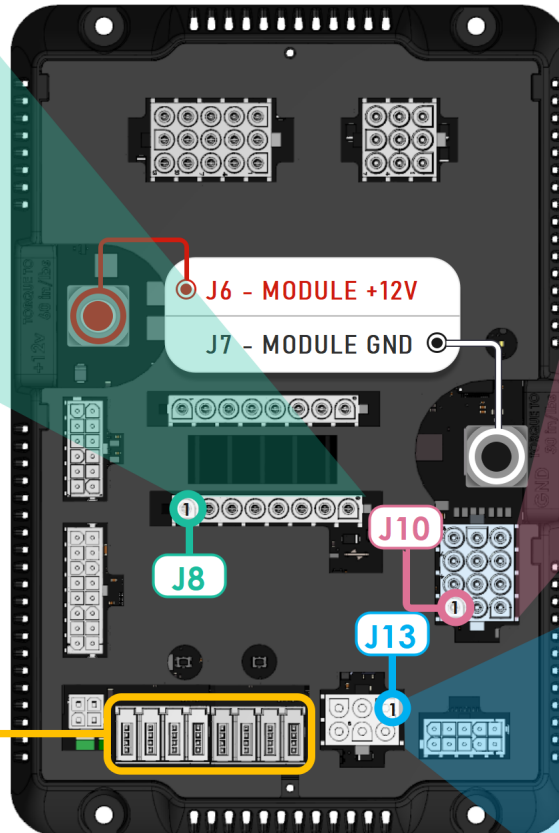

## J10

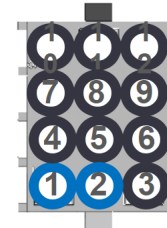

- |                       |          |
|-----------------------|----------|
| 1 Electric Water Heat | 7 Spare  |
| 2 Gas Water Heat      | 8 Spare  |
| 3 Spare               | 9 Spare  |
| 4 Spare               | 10 Spare |
| 5 Spare               | 11 Spare |
| 6 Spare               | 12 Spare |

## J13

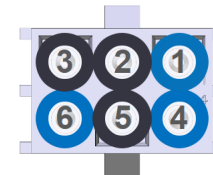

- |                    |                        |
|--------------------|------------------------|
| 1 LPG Sensor Input | 4 LPG Sensor GND       |
| 2 Spare            | 5 Spare                |
| 3 Spare            | 6 Gen Run Input Status |

Net Ports

### J4

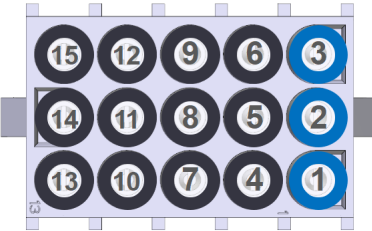

1 Hall Lights (CH30)	9 N/A
2 Entry Light (CH31)	10 N/A
3 Porch Light (CH32)	11 N/A
4 N/A	12 N/A
5 N/A	13 N/A
6 N/A	14 N/A
7 N/A	15 N/A
8 N/A	

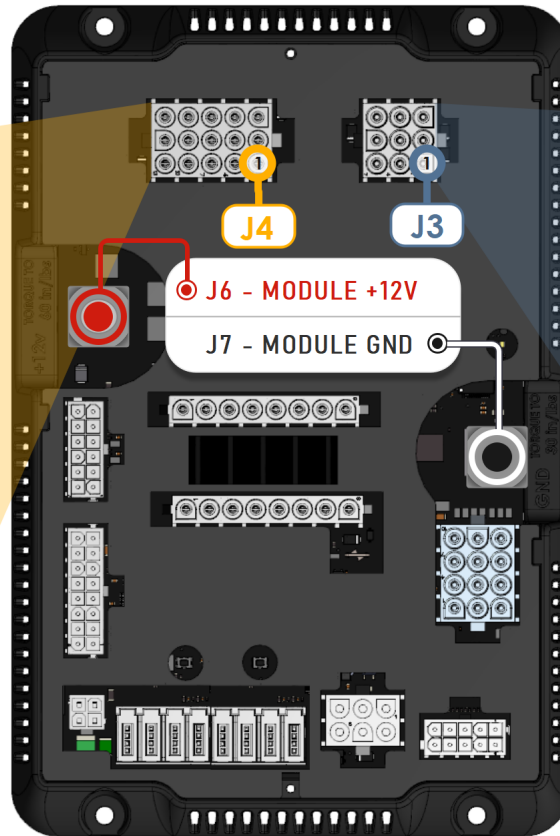

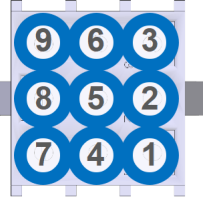

G12 Module

### J3

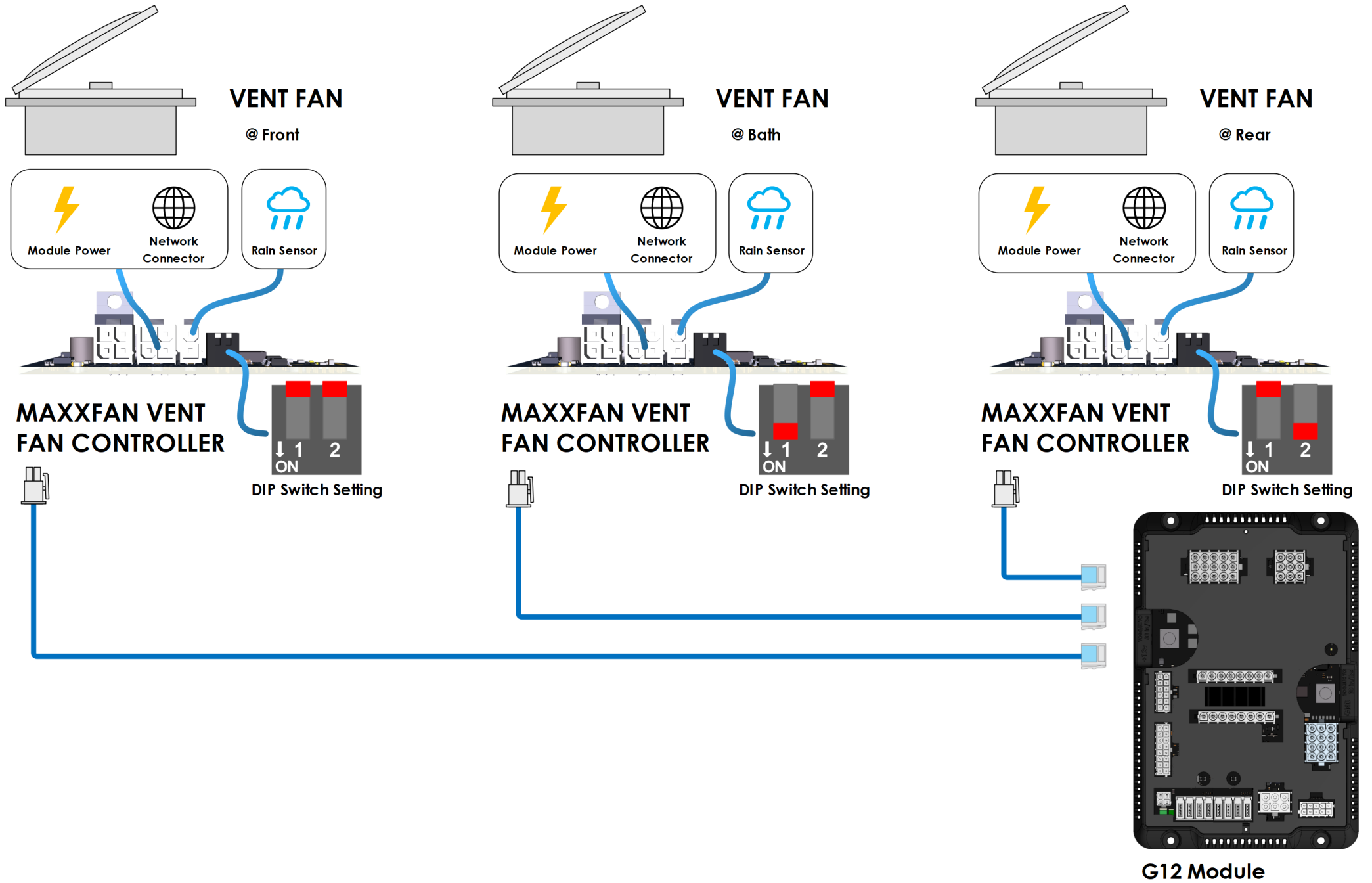

1 Main O/H/Living Room Lt	6 Bathroom Lt
2 Sofa Reading Lt	7 Shower Lt
3 Bedroom Lt	8 Front Accent
4 Bed Reading Lt	9 Task Lt
5 Bed Slide/ Cabinet Acnt	



If a switch has the  symbol nearby, it means the switch or module communicates via RF.

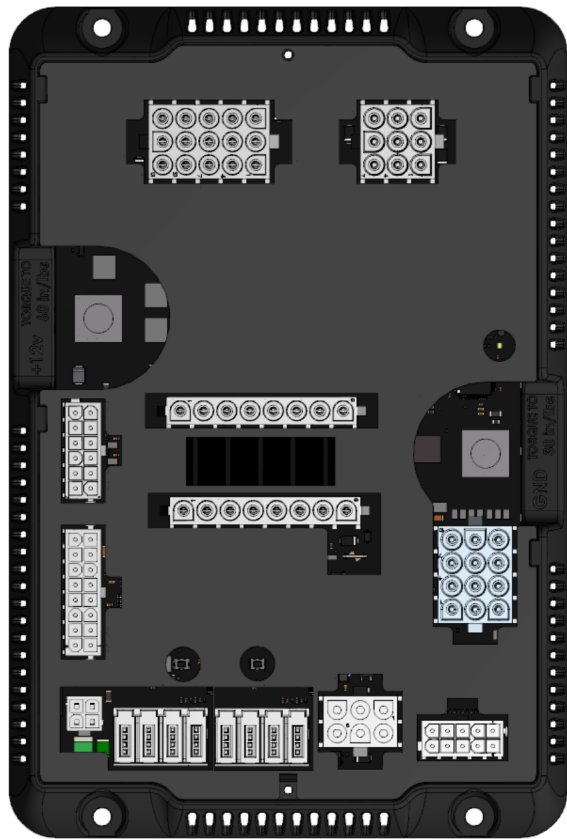

**G12 Module**  
© Under Bed

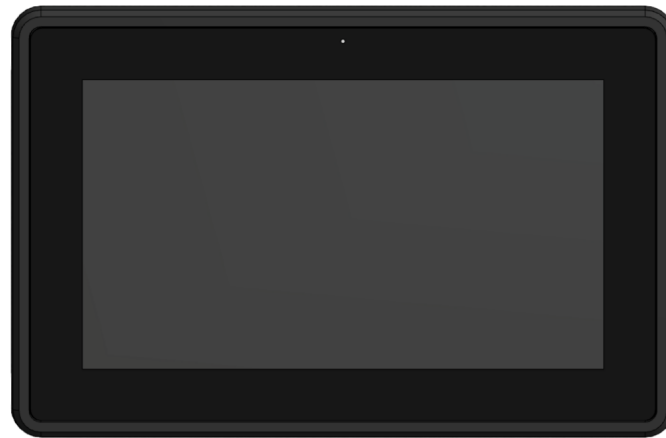

**7" Color LCD**  
Tiffin P/N: 5143168

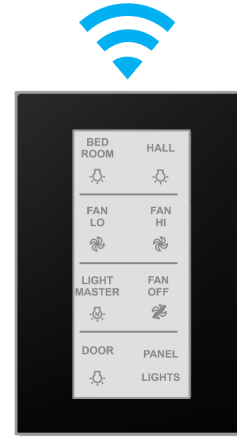
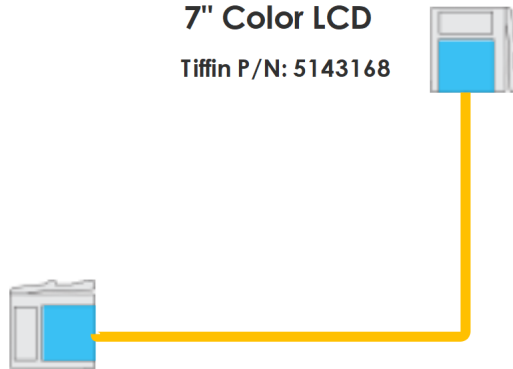

**Bedroom Switch Panel**

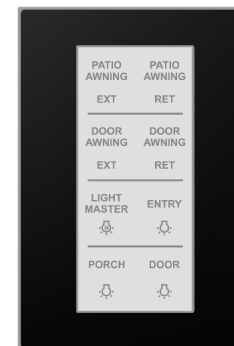

**Entry Switch Panel**

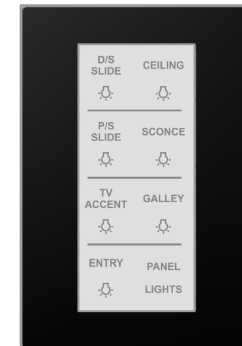

**Bath Switch Panel**

## **i** Emergency Override

Park brake and ignition must be on for slides to operate. In case of a system failure, use manual overrides on the G12 to operate slides. Engage overrides using a pen or other pointed object.

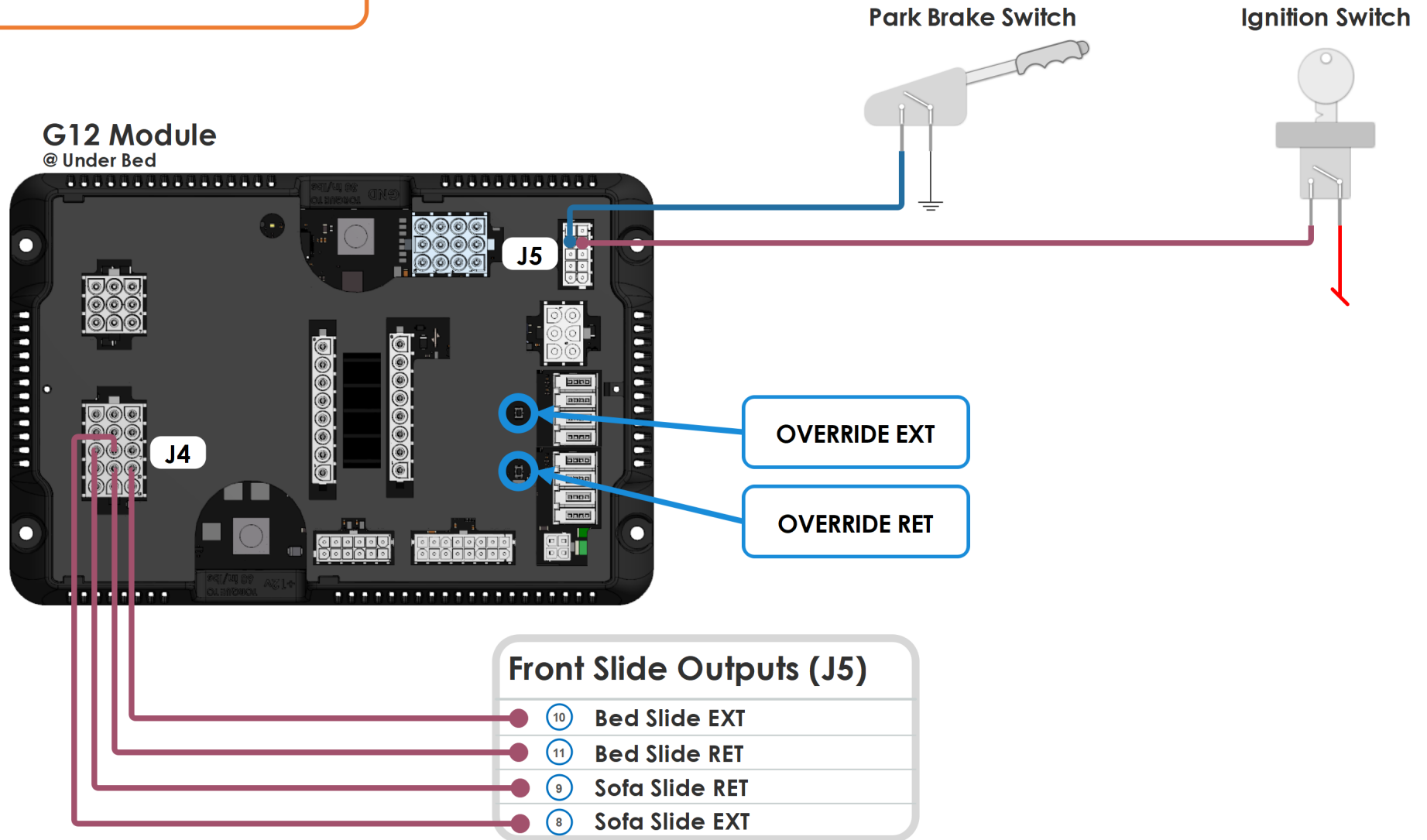

## G12 Module

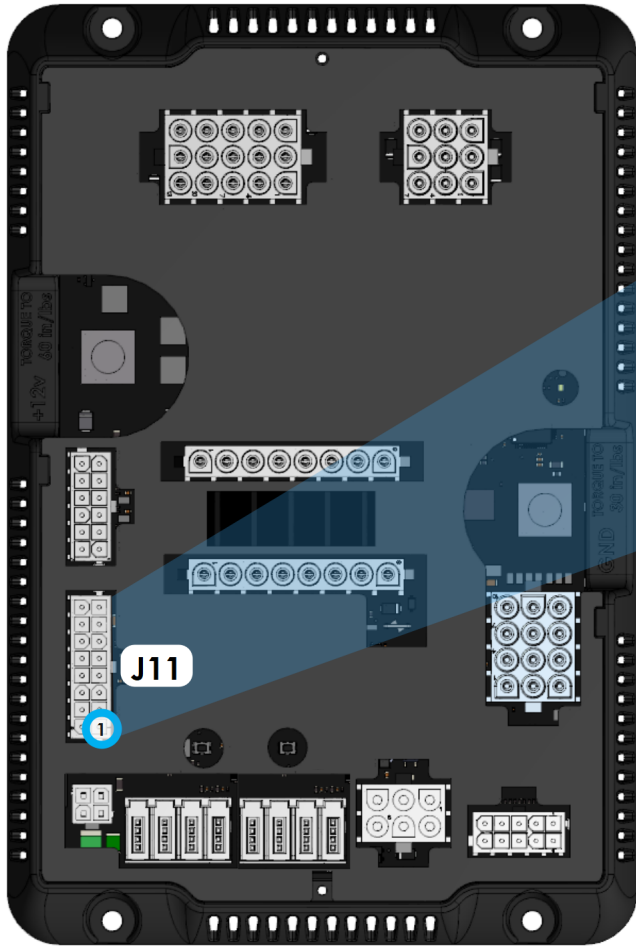

## 3 Level Tank Sensor System

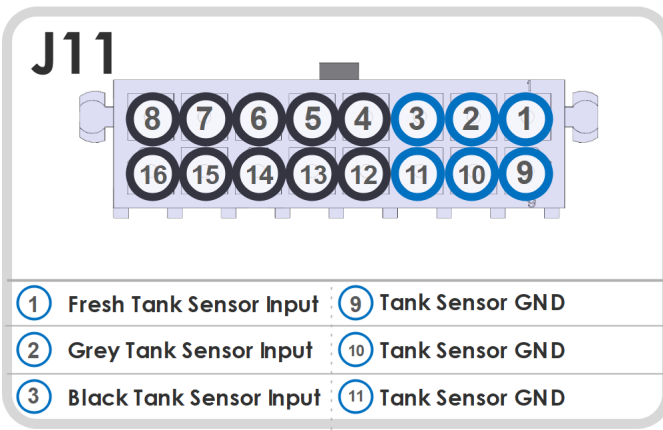
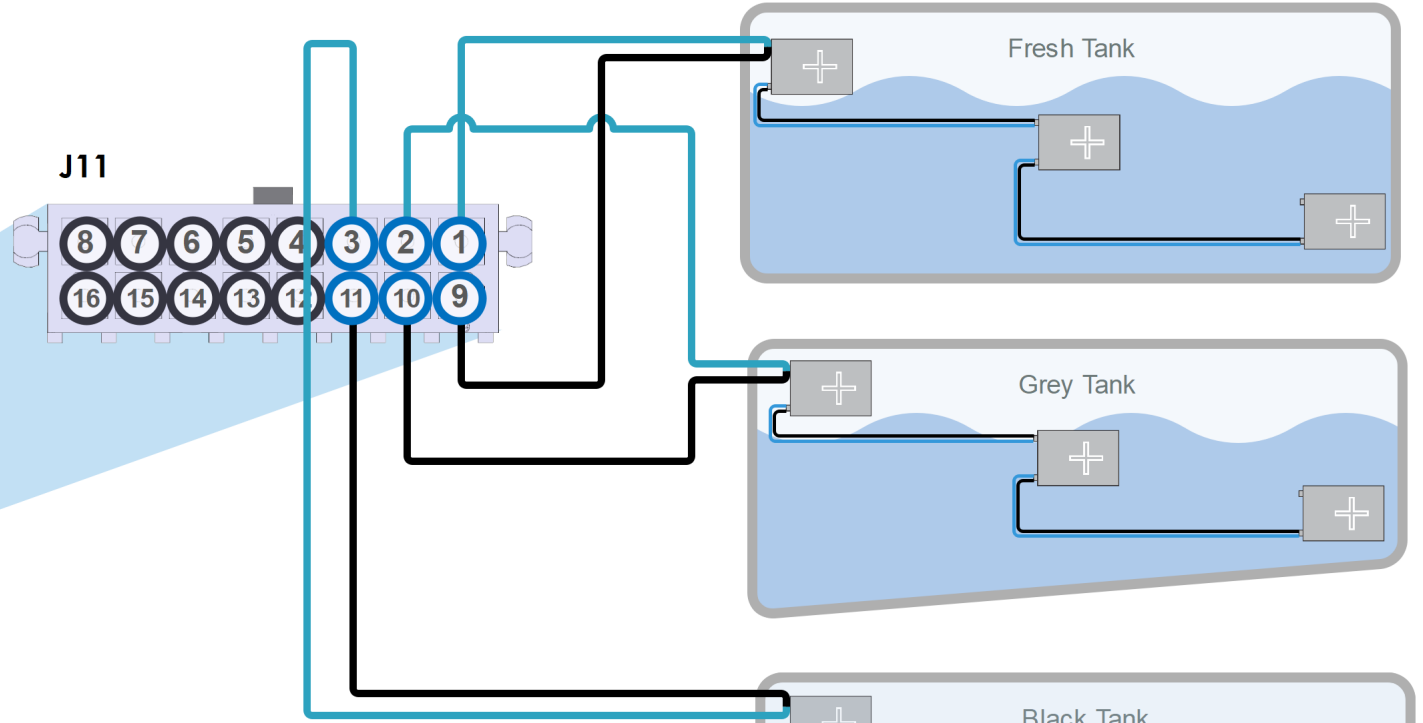

**NOTE:** If Unit has a combined Fresh & Grey tank then the J11 input for the Grey tank is not used.

## G12 Module @ Under Bed

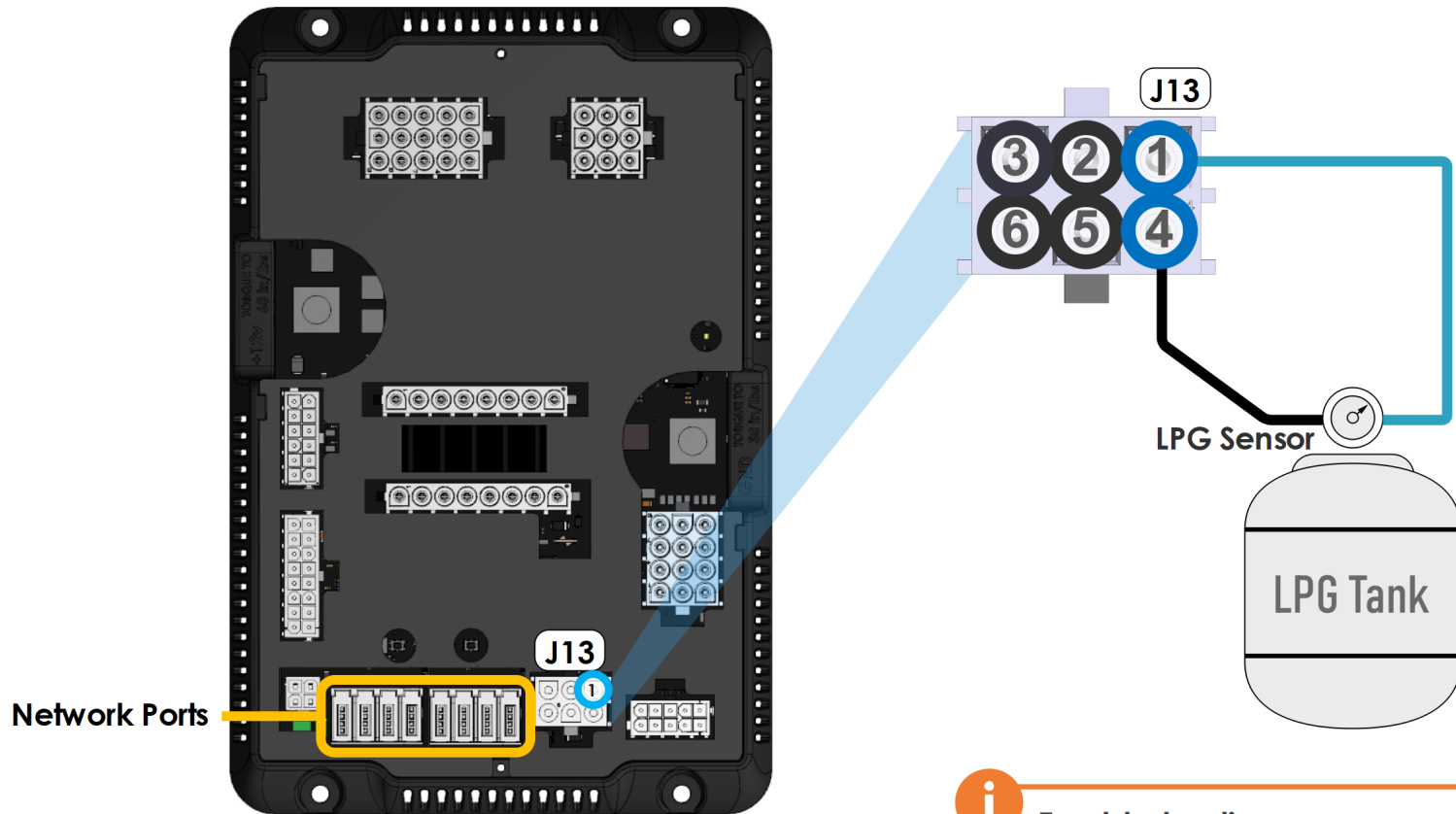

**i Troubleshooting**

The LP sensor will read full at 90 Ohms and empty at 0 Ohms. If the readings are outside of this range a fault will display on the screen inside the coach.

## G12 Module

@ Under Bed

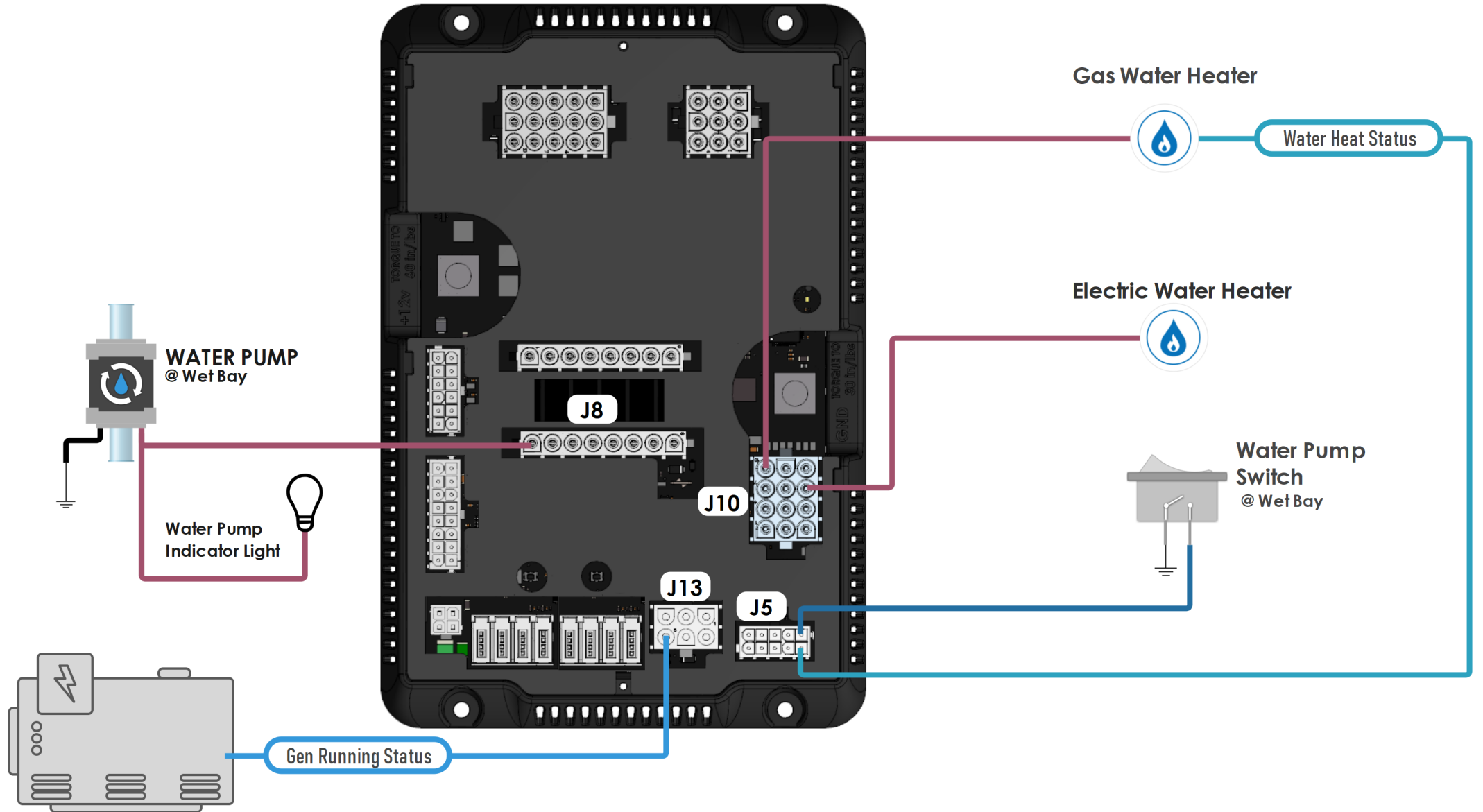

**G3 Terminator Tap**  
Tiffin P/N: 5051935

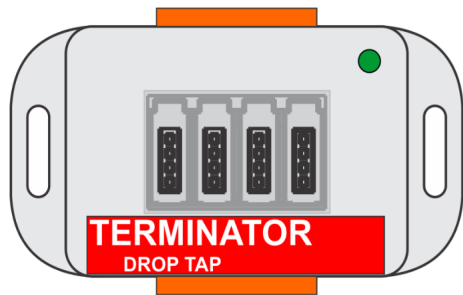

**G3 Common Tap**  
Tiffin P/N: 5027834

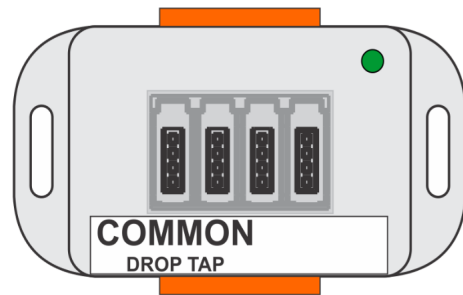

**G4 Common Drop Tap**  
Tiffin P/N: 5016592



**Mini-Clamp Plug**  
Tiffin P/N: 5066157



**G4 Terminator Drop Tap**  
Tiffin P/N: 5051936



**Mini-Clamp Socket**  
Tiffin P/N: 5066158



**4 Pos Wago Connector**  
Tiffin P/N: 5015508

