

DIAGNOSTIC LED FEATURES

Each SWITCH PANEL and CONTROL PANEL has built-in diagnostic LED indicators. The CHANNEL LED corresponds with the circuit listed on the chart to the left and indicates if the circuit is ON or OFF. The NETWORK LED indicates if the panel has power and whether or not it is communicating with the other panels within the network.

In the event of a switch panel with a NETWORK LED that indicates a fault, unplug the SWITCH PANEL and plug it directly into the NETWORK PORT on one of the CONTROL PANELS. If the SWITCH PANEL LED turns solid green, this could indicate a network wiring issue. Refer to the NETWORK WIRING GUIDE in the previous page.

House Panel		
Channel	Pinout	Load
1	1-1	MAIN O/H / LIV RM LIGHT
2	1-2	ENTRY / FLOOR LIGHT
3	1-3	P/S CEILING LIGHTS
4	1-4	D/S CEILING LIGHTS
5	2-1	MID HALL LIGHTS
6	2-2	P/S SLIDE LIGHTS
7	2-3	P/S SCONCE
8	2-4	D/S SLIDE LIGHTS
9	3-1	D/S SCONCE
10	3-2	BED READING LIGHTS (REAR)
11	3-3	BED SCONCE LIGHTS
12	3-4	BEDROOM LIGHTS
13	4-1	REAR BATH/MID SINK CEILING LIGHTS
14	4-2	TASK LIGHTS
15	4-3	MID BATH CEILING LIGHTS
16	4-4	MID BATH VANITY LIGHTS
17	5-1	REAR BATH/MID SINK VANITY LIGHTS
18	5-2	TV ACCENT LIGHTS
19	5-3	FRONT ACCENT LIGHTS
20	5-4	REAR ACCENT LIGHTS
21	6-1	ROAD LIGHT
22	6-2	PORCH LIGHT
23	6-3	ELECTRIC WTR HT
24	6-4	DIESEL / GAS WTR HT
25	7-1	GALLEY FAN ON/OFF
26	7-2	GALLEY FAN UP
27	7-3	GALLEY FAN DN
28	7-4	CLOSET LIGHTS (OPTIONAL)
29	8-1	MID BATH FAN ON/OFF
30	8-2	MID BATH FAN UP
31	8-3	MID BATH FAN DN
32	8-4	REAR BATH / MID SINK FAN ON/OFF
33	9-1	REAR BATH / MID SINK FAN UP
34	9-2	REAR BATH / MID SINK FAN DN
35	9-3	CEILING FAN LO
36	9-4	CEILING FAN HI
37	10-1	FLOOR HEAT TRIGGER - ZONE 1 (OPTIONAL)
38	10-2	FLOOR HEAT TRIGGER - ZONE 2 (OPTIONAL)
39	10-3	AQUA-HOT ELEC - HI (OPTIONAL)
40	10-4	AQUA-HOT ELEC - LO (OPTIONAL)
41	11-1	
42	11-2	
43	11-3	
44	11-4	
45	12-1	
46	12-2	
47	12-3	
48	12-4	

Chassis Panel		
Channel	Pinout	Load
1	1-1	D/S FR SLIDE RET
2	1-2	D/S FR SLIDE EXT
3	1-3	P/S FR SLIDE RET
4	1-4	P/S FR SLIDE EXT
5	2-1	D/S RR SLIDE RET
6	2-2	D/S RR SLIDE EXT
7	2-3	P/S RR SLIDE RET
8	2-4	P/S RR SLIDE EXT
9	3-1	HYDRAULIC PUMP - D/S SLIDE
10	3-2	HYDRAULIC PUMP - P/S SLIDE
11	3-3	PORCH / DOOR CONSTANT / UNDERCOACH LTS
12	3-4	AQUA-HOT ENGINE PREHEAT
13	4-1	WATER PUMP
14	4-2	HEADLIGHTS (INDICATION FLASH)
15	4-3	DOOR / ASSIST HANDLE
16	4-4	CARGO LIGHT
17	5-1	GALLEY SLIDE DAY SHD UP/DOOR AAWN RET
18	5-2	GALLEY SLIDE SHD DN/DOOR AAWN EXT
19	5-3	GALLEY SLIDE NIGHT SHD UP/PORCH AAWN RET
20	5-4	GALLEY SLIDE NIGHT SHD DN/PORCH AAWN EXT
21	6-1	ENTRY SHADE UP
22	6-2	ENTRY SHD DN
23	6-3	GEN START
24	6-4	GEN STOP

CONTROL PANEL LED INDICATORS

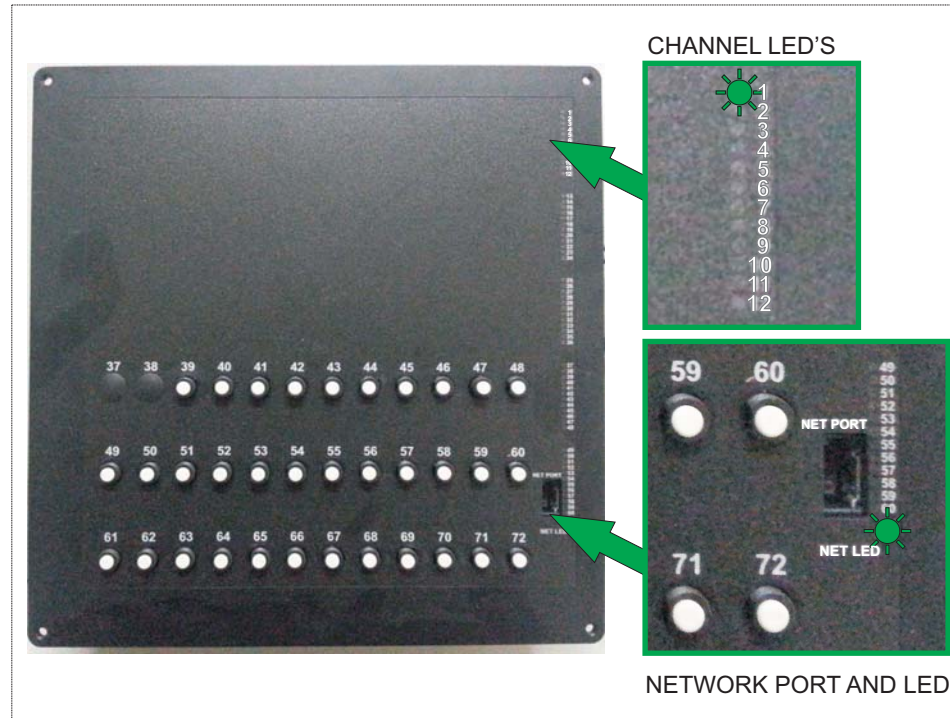

CONTROL PANEL LED INDICATORS

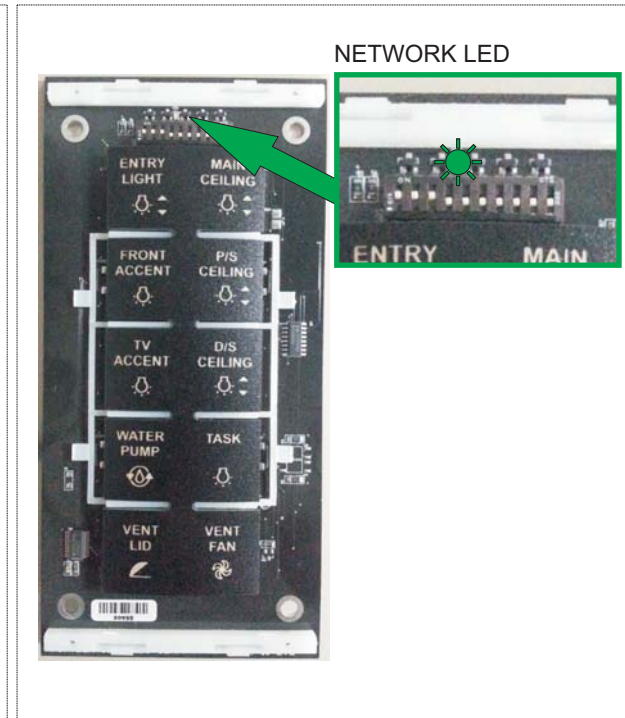

NETWORK STATUS LED INDICATOR

- ★ - SOLID GREEN - device is connected to network and communicating properly
 - - LED OFF - device has no power or has completely failed
- ★ - SOLID RED - device has gone offline and is not connected to network
 - ★ / ○ - FAST FLASHING GREEN (4 times / sec.) - device is attempting to make initial connection and claim a network address
 - ★ / ○ - SLOW FLASHING GREEN (1 time / sec.) - device was online but has not seen a valid network message for 5 seconds
 - ★ / ★ - ALTERNATING RED & ORANGE - device has gone offline and is attempting to re-connect (within 30 seconds)
 - ★ / ★ - ALTERNATING GREEN & ORANGE - device is currently online but has gone offline 2 or more times

2015 RED NETWORK WIRING DIAGRAM

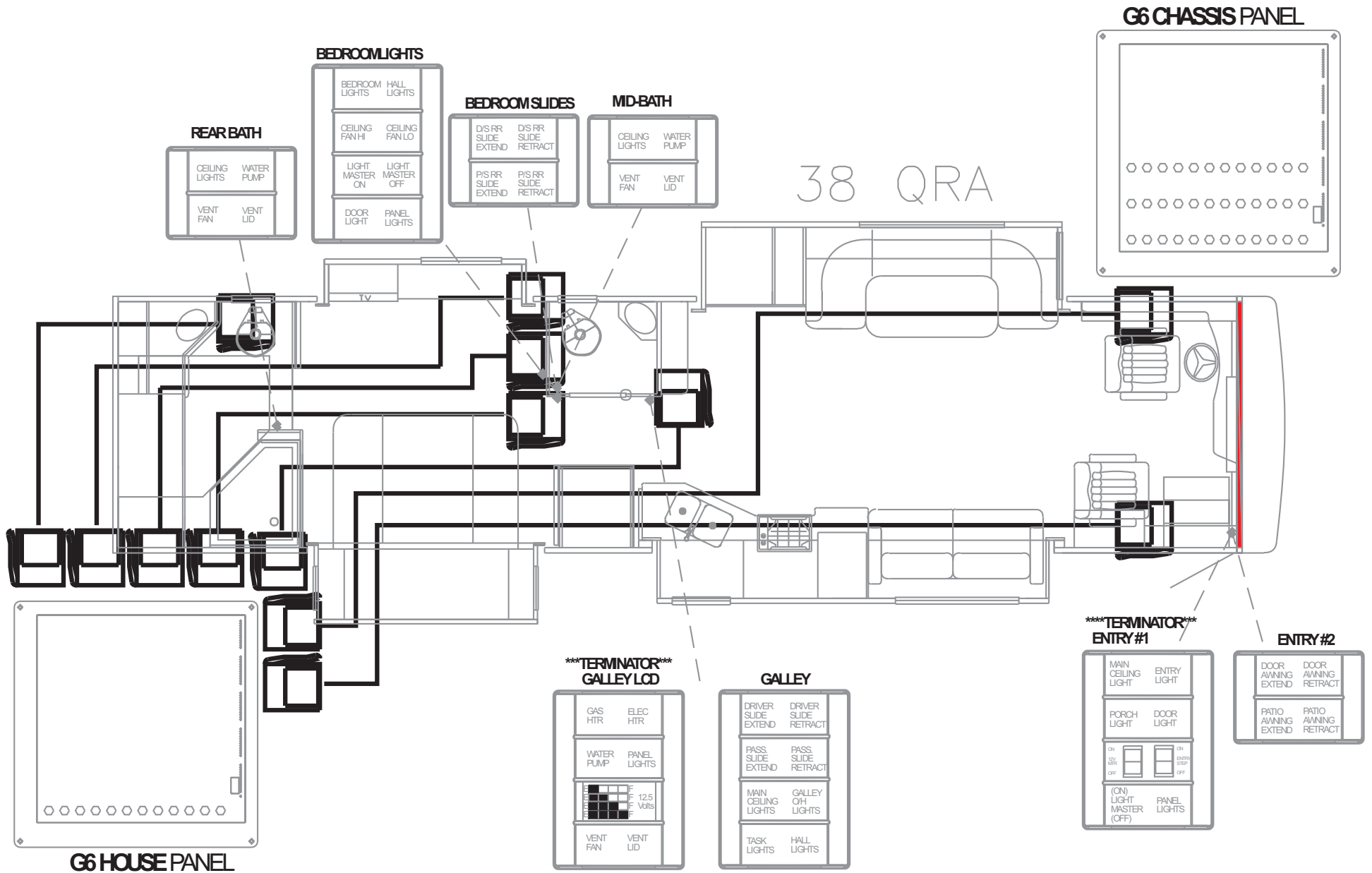

2015 ZEPHYR, BUS, PHAETON, RED ----- G6A Control Panel Load List
09.30.2014

House Panel												
#	Type	Channel	Pinout	Load	Amps	Type	Notes	ZEPH	BUS	PHTN	RED	
1	DIMMER	1	1-1	MAIN O/H / LV RM LIGHT	7	PTC Fuse		X	X	X	X	
		2	1-2	ENTRY / FLOOR LIGHT	7	PTC Fuse		X	X			
		3	1-3	PS CEILING LIGHTS	7	PTC Fuse		X	X			
		4	1-4	DS CEILING LIGHTS	7	PTC Fuse		X	X			
		5	2-1	MID HALL LIGHTS	7	PTC Fuse		X	X	X	X	
		6	2-2	PS SLIDE LIGHTS	7	PTC Fuse		X	X			
		7	2-3	PS SCONCE	7	PTC Fuse		X	X			
		8	2-4	DS SLIDE LIGHTS	7	PTC Fuse		X	X			
		9	3-1	DS SCONCE	7	PTC Fuse		X	X			
		10	3-2	BED READING LIGHTS (REAR)	7	PTC Fuse		X	X			
		11	3-3	BED SCONCE LIGHTS	7	PTC Fuse		X	X			
		12	3-4	BEDROOM LIGHTS	7	PTC Fuse		X	X	X	X	
2	HC Relay	13	4-1	REAR BATH/MID SINK CEILING LIGHTS	7	PTC Fuse		X	X	X	X	
		14	4-2	TASK LIGHTS	7	PTC Fuse		X	X	X	X	
		15	4-3	MID BATH CEILING LIGHTS	7	PTC Fuse		X	X	X	X	
		16	4-4	MID BATH VANITY LIGHTS	7	PTC Fuse		X	X	X	X	
		17	5-1	REAR BATH/MID SINK VANITY LIGHTS	7	PTC Fuse		X	X	X	X	
		18	5-2	TV ACCENT LIGHTS	7	PTC Fuse		X	X	X	X	
		19	5-3	FRONT ACCENT LIGHTS	7	PTC Fuse		X	X	X	X	
		20	5-4	REAR ACCENT LIGHTS	7	PTC Fuse		X	X			
		21	6-1	ROAD LIGHT	7	PTC Fuse		X	X	X	X	
		22	6-2	PORCH LIGHT	7	PTC Fuse		X	X	X	X	
		23	6-3	ELECTRIC WTR HT	7	PTC Fuse		USED ON ALL WTR HTR'S	X	X	X	X
		24	6-4	DIESEL / GAS WTR HT	7	PTC Fuse		NOT USED FOR PRECISION TEMP	X	X	X	X
3	HC Relay	25	7-1	GALLEY FAN ON/OFF	7	PTC Fuse		X	X	X	X	
		26	7-2	GALLEY FAN UP	7	PTC Fuse	REV POLARITY	X	X	X	X	
		27	7-3	GALLEY FAN DN	7	PTC Fuse	REV POLARITY	X	X	X	X	
		28	7-4	CLOSET LIGHTS (OPTIONAL)	7	PTC Fuse		X	X	X	X	
		29	8-1	MID BATH FAN ON/OFF	7	PTC Fuse		X	X	X	X	
		30	8-2	MID BATH FAN UP	7	PTC Fuse	REV POLARITY	X	X	X	X	
		31	8-3	MID BATH FAN DN	7	PTC Fuse	REV POLARITY	X	X	X	X	
		32	8-4	REAR BATH / MID SINK FAN ON/OFF	7	PTC Fuse		X	X	X	X	
		33	9-1	REAR BATH / MID SINK FAN UP	7	PTC Fuse	REV POLARITY	X	X	X	X	
		34	9-2	REAR BATH / MID SINK FAN DN	7	PTC Fuse	REV POLARITY	X	X	X	X	
		35	9-3	CEILING FAN LO	7	PTC Fuse	10W 10R RESISTOR INLINE	X	X	X	X	
		36	9-4	CEILING FAN HI	7	PTC Fuse		X	X	X	X	
4	HC Relay	37	10-1	FLOOR HEAT TRIGGER - ZONE 1 (OPTIONAL)	7	PTC Fuse		X	X	X	X	
		38	10-2	FLOOR HEAT TRIGGER - ZONE 2 (OPTIONAL)	7	PTC Fuse		X	X	X	X	
		39	10-3	AQUA-HOT ELEC - HI (OPTIONAL)	7	PTC Fuse		X	X			
		40	10-4	AQUA-HOT ELEC - LO (OPTIONAL)	7	PTC Fuse		X	X			
		41	11-1									
		42	11-2									
		43	11-3									
		44	11-4									
		45	12-1									
		46	12-2									
		47	12-3									
		48	12-4									
5	IS-8m (Input Module)	1	14-1	WTR HTR STATUS		12V+ IN	NOT USED FOR PRECISION TEMP	X	X	X	X	
		3	14-2	IGNITION INPUT		12V+ IN		X	X	X	X	
		5	14-3									
		7	14-4									
		9	14-5									
		2	15-1	WATER PUMP SWITCH		GND IN	SWITCH IN PLUMBING BAY	X	X	X	X	
		4	15-2	PARK BRAKE INPUT		GND IN		X	X	X	X	
		6	15-3	CLOSET LIGHT SWITCH		GND IN		X	X	X	X	
		8	15-4	ENTRY DOOR PIN SWITCH		GND IN		X	X			
		10	15-5									
6	Breaker	61	16-1	MACERATOR TOILET	35	MANUAL		X	X	X	X	
		62	16-2	FRONT FURNACE	15	MANUAL			X	X		
		63	16-3	REAR FURNACE	15	MANUAL			X	X		
		64	16-4	SWITCHER / LP / IR REPEATER	10	MANUAL		X	X	X	X	
		65	16-5	OUTSIDE TV OUTLET	20	MANUAL		X	X	X	X	
		66	16-6	BRKR TO FR SLIDES / SHADE MODULE	10	MANUAL		X	X	X	X	
		67	18-1	FRONT THERMO	10	MANUAL		X	X	X	X	
		68	18-2	MID THERMO	10	MANUAL		X	X			
		69	18-3	TOILET/REAR THERMO	10	MANUAL		X	X	X	X	
		70	18-4	BRKR TO RR SLIDES	10	MANUAL		X	X	X	X	
		71	18-5	FRIDGE	25	MANUAL		X	X	X	X	
		72	18-6		15	MANUAL					X	

Chassis Panel												
#	Type	Channel	Pinout	Load	Amps	Type	Notes	ZEPH	BUS	PHTN	RED	
1	HC Relay (IGN & Park)	1	1-1	D/S FR SLIDE RET	7	PTC Fuse	HWH	X	X	X	X	
		2	1-2	D/S FR SLIDE EXT	7	PTC Fuse	HWH	X	X	X	X	
		3	1-3	P/S FR SLIDE RET	7	PTC Fuse	HWH	X	X	X	X	
		4	1-4	P/S FR SLIDE EXT	7	PTC Fuse	HWH	X	X	X	X	
		5	2-1	D/S RR SLIDE RET	7	PTC Fuse	SWINTECH	X	X	X	X	
		6	2-2	D/S RR SLIDE EXT	7	PTC Fuse	SWINTECH	X	X	X	X	
		7	2-3	P/S RR SLIDE RET	7	PTC Fuse	SWINTECH	X	X	X	X	
		8	2-4	P/S RR SLIDE EXT	7	PTC Fuse	SWINTECH	X	X	X	X	
		9	3-1	HYDRAULIC PUMP - D/S SLIDE	7	PTC Fuse	ON ONLY WITH HWH SLIDES	X	X	X	X	
		10	3-2	HYDRAULIC PUMP - P/S SLIDE	7	PTC Fuse	ON ONLY WITH HWH SLIDES	X	X	X	X	
		11	3-3	PORCH / DOOR CONSTANT / UNDERCOACH LTS	7	PTC Fuse		X	X			
		12	3-4	AQUA-HOT ENGINE PREHEAT	7	PTC Fuse		X	X			
2	HC Relay	13	4-1	WATER PUMP	7	PTC Fuse		X	X	X	X	
		14	4-2	HEADLIGHTS (INDICATION FLASH)	7	PTC Fuse	FLASH ON LOCK/UNLOCK	X	X			
		15	4-3	DOOR / ASSIST HANDLE	7	PTC Fuse		X	X	X	X	
		16	4-4	CARGO LIGHT	7	PTC Fuse	30 MINUTE TIMER	X	X	X	X	
		17	5-1	GALLEY SLIDE DAY SHD UP/DOOR AWWN RET	7	PTC Fuse	REV POLARITY	X	X	X	X	
		18	5-2	GALLEY SLIDE SHD DN/DOOR AWWN EXT	7	PTC Fuse	REV POLARITY	X	X	X	X	
		19	5-3	GALLEY SLIDE NIGHT SHD UP/PORCH AWWN RET	7	PTC Fuse	REV POLARITY	X	X	X	X	
		20	5-4	GALLEY SLIDE NIGHT SHD DN/PORCH AWWN EXT	7	PTC Fuse	REV POLARITY	X	X	X	X	
		21	6-1	ENTRY SHADE UP	7	PTC Fuse	REV POLARITY	X	X			
		22	6-2	ENTRY SHD DN	7	PTC Fuse	REV POLARITY	X	X			
		23	6-3	GEN START	7	PTC Fuse		X	X			
		24	6-4	GEN STOP	7	PTC Fuse		X	X			
3	Breaker Module (GFI)	25										
		26										
		27										
		28										
		29										
		30										
		31										
		32										
		33										
		34										
		35										
		36										
4	Breaker Module (GFI)	37	10-1									
		38	10-2									
		39	10-3	DENSO A/C POWER IGNITION (YELLOW)	20				X	X	X	X
		40	10-4	MIRRORS	15	AUTO			X	X	X	X
		41	10-5	CAMERA IGN	5	MANUAL			X	X	X	X
		42	10-6	JACK BUZZER	5	MANUAL			X	X	X	X
		43	12-1	PANEL LAMP / HDLT	5	MANUAL			X	X	X	X
		44	12-2	FRIDGE	5	AUTO			X	X	X	X
		45	12-3	ENTRY STEP IGN	5	AUTO			X	X	X	X
		46	12-4	DOCK LIGHT	15	AUTO			X	X	X	X
		47	12-5	WIOPER	35	AUTO			X	X	X	X
		48	12-6	POWER WINDOW OPTION	15	AUTO			X	X	X	X
5	Breaker Module (House Constant)	49	13-1	MAP LT / RADIO / FANS	15	MANUAL		X	X	X	X	
		50	13-2	USB POWER	15	MANUAL		X	X	X	X	
		51	13-3	KEYLESS POWER	15	MANUAL		X	X	X	X	
		52	13-4	ENTRY STEP SWITCH	5	MANUAL		X	X	X	X	
		53	13-5	ENTRY STEP POWER	20	AUTO		X	X	X	X	
		54	13-6	CARGO LIGHTS (CONSTANT)	10	MANUAL		X	X	X	X	
		55	15-1	POWER SEAT #1	20	AUTO		X	X	X	X	
		56	15-2	CB	5	MANUAL						
		57	15-3	ELEC STEP COVER	10	AUTO		X	X			
		58	15-4	SATELITE	5	MANUAL		X	X	X	X	
		59	15-5	SHADES	5	MANUAL		X	X			
		60	15-6	POWER SEAT #2	20	AUTO		X	X	X	X	
6	Breaker Module (House Constant)	61	16-1	RADIO MEMORY / XM POWER	15	MANUAL		X	X	X	X	
		62	16-2	DENSO A/C POWER	20	AUTO			X	X	X	
		63	16-3	12V+ OUTLET #1	20	MANUAL		X	X	X	X	
		64	16-4	12V+ OUTLET #2	20	MANUAL		X	X	X	X	
		65	16-5	120V ENGINE PREHEAT SWITCH	5	MANUAL		X	X	X	X	
		66	16-6	AQUA-HOT (option)	20	MANUAL						
		67	18-1	EMS MODULE	5	MANUAL		X	X	X		
		68	18-2	CORD REEL	10	AUTO		X	X	X		
		69	18-3	HOSE REEL	10	AUTO		X	X	X		
		70	18-4	FRONT SLIDE-OUT MODULE	20	AUTO		X	X	X	X	
		71	18-5	VANITY SLIDE MODULE	20	AUTO		X	X	X	X	
		72	18-6	BED SLIDE MODULE	20	AUTO		X	X	X	X	

SHADE MODULE (for all shades in the non-galley slide-out)											
#	Type	Channel	Pinout	Load	Amps	Type	Notes	ZEPH	BUS	PHTN	RED
1	SHADE MODULE	1	1-1	FRONT DAY SHD UP (37AP only non-galley)	1	SOLID STATE		X	X		
		2	1-2	FRONT DAY SHD DN (37AP only non-galley)	1	SOLID STATE		X	X		
		3	1-3	FRONT NT SHD UP (37AP only non-galley)	1	SOLID STATE		X	X		
		4	1-4	FRONT							

**G6A CONTROL PANEL LAYOUT
RED - HOUSE
PINOUT DIAGRAM - 12/23/2014**

Back View

- CONNECTOR 4**
- 4-1 REAR BATH/MID SINK CEILING LIGHTS
 - 4-2 TASK LIGHTS
 - 4-3 MID BATH CEILING LIGHTS
 - 4-4 MID BATH VANITY LIGHTS

- CONNECTOR 5**
- 5-1 REAR BATH/MID SINK VANITY LIGHTS
 - 5-2 TV ACCENT LIGHTS
 - 5-3 FRONT ACCENT LIGHTS
 - 5-4 REAR ACCENT LIGHTS

- CONNECTOR 6**
- 6-1 ROAD LIGHT
 - 6-2 PORCH LIGHT
 - 6-3 ELECTRIC WTR HT
 - 6-4 DIESEL / GAS WTR HT

- CONNECTOR 14 (12V+ INPUTS)**
- 14-1 WTR HTR STATUS
 - 14-2 IGNITION INPUT
 - 14-3 HOUSE DISCONNECT 12V+
 - 14-4
 - 14-5

- CONNECTOR 15 (GND INPUTS)**
- 15-1 WATER PUMP SW
 - 15-2 PARK BRAKE INPUT
 - 15-3 CLOSET LIGHT SW
 - 15-4 ENTRY DOOR PIN SW
 - 15-5

- CONNECTOR 18**
- 18-1 FRONT THERMO
 - 18-2 MID THERMO
 - 18-3 TOILET/REAR THERMO
 - 18-4 BRKR TO RR SLIDE
 - 18-5 **FRIDGE**
 - 18-6

- CONNECTOR 16**
- 16-1 MACERATOR TOILET
 - 16-2 FRONT FURNACE
 - 16-3 REAR FURNACE
 - 16-4 SWITCHER / LP/IR
 - 16-5 OUTSIDE TV
 - 16-6 BRKR TO FR SLD / SHD MOD

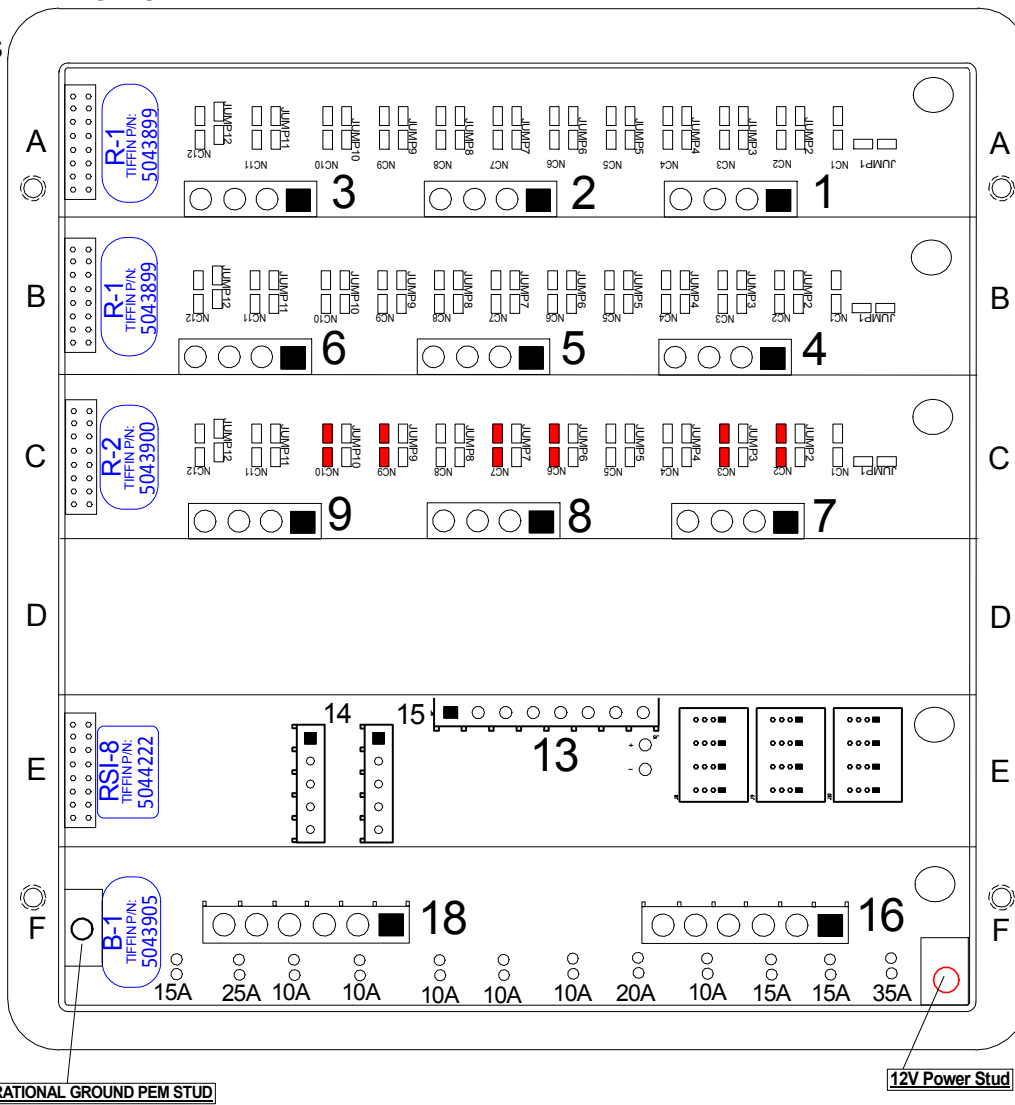

OPERATIONAL GROUND PEM STUD

12V Power Stud

- CONNECTOR 1**
- 1-1 MAIN O/H / LIV RM LIGHT
 - 1-2 ENTRY / FLOOR LIGHT
 - 1-3 PS CEILING LIGHTS
 - 1-4 DS CEILING LIGHTS

- CONNECTOR 2**
- 2-1 MID HALL LIGHTS
 - 2-2 PS SLIDE LIGHTS
 - 2-3 PS SCONCE
 - 2-4 DS SLIDE LIGHTS

- CONNECTOR 3**
- 3-1 DS SCONCE
 - 3-2 BED READING LIGHTS (REAR)
 - 3-3 BED SCONCE LIGHTS
 - 3-4 BEDROOM LIGHTS

- CONNECTOR 7**
- 7-1 GALLEY FAN ON/OFF
 - 7-2 GALLEY FAN UP
 - 7-3 GALLEY FAN DN
 - 7-4 CLOSET LIGHTS (OPTIONAL)

- CONNECTOR 8**
- 8-1 MID BATH FAN ON/OFF
 - 8-2 MID BATH FAN UP
 - 8-3 MID BATH FAN DN
 - 8-4 REAR BATH / MID SINK FAN ON/OFF

- CONNECTOR 9**
- 9-1 REAR BATH / MID SINK FAN UP
 - 9-2 REAR BATH / MID SINK FAN DN
 - 9-3 CEILING FAN LO
 - 9-4 CEILING FAN HI

- CONNECTOR 13**
- Pin 1: Unused
 - Pin 2: Constant 12V+ (BATT)
 - Pin 3: GND (Common for sensors)
 - Pin 4: LPG Sensor Input
 - Pin 5: Black Tank Sensor Input
 - Pin 6: Grey Tank Sensor Input
 - Pin 7: Fresh Tank Sensor Input
 - Pin 8: Unused

Card Legend

- R=RELAY CARD
- B=BREAKER CARD
- RSI-8=INPUT MODULE
- D=DIMMER CARD
- = JUMPERED

NOTE: CONNECTORS ARE SHOWN HERE IN THE LOADED (REAR) VIEW.

**G6A CONTROL PANEL LAYOUT
ZEPH, BUS, PHTN, RED - CHASSIS
PINOUT DIAGRAM - 11/05/ 2014**

Back View

- CONNECTOR 4**
- 4-1 WATER PUMP
 - 4-2 HEADLIGHTS (INDICATION FLASH)
 - 4-3 DOOR / ASSIST HANDLE
 - 4-4 CARGO LIGHT

- CONNECTOR 5**
- 5-1 SOFA DAY SHD UP/DOOR AWN RET
 - 5-2 SOFA DAY SHD DN/DOOR AWN EXT
 - 5-3 SOFA NIGHT SHD UP/PORCH AWN RET
 - 5-4 SOFA NIGHT SHD DN/PORCH AWN EXT

- CONNECTOR 6**
- 6-1 ENTRY SHADE UP
 - 6-2 ENTRY SHD DN
 - 6-3 GEN START
 - 6-4 GEN STOP

- CONNECTOR 13**
- 13-1 MAP LT / RADIO / FANS
 - 13-2 USB POWER
 - 13-3 KEYLESS POWER
 - 13-4 ENTRY STEP SWITCH
 - 13-5 ENTRY STEP POWER
 - 13-6 CARGO LIGHTS (CONST)

- CONNECTOR 15**
- 15-1 POWER SEAT #1
 - 15-2 CB
 - 15-3 ELEC STEP COVER
 - 15-4 SATELITE
 - 15-5 SHADES
 - 15-6 POWER SEAT #2

Card Legend

- R=RELAY CARD**
- B=BREAKER CARD**
- BR=BREAKER/
RELAY CARD**
- D=DIMMER CARD**
- = JUMPERED**

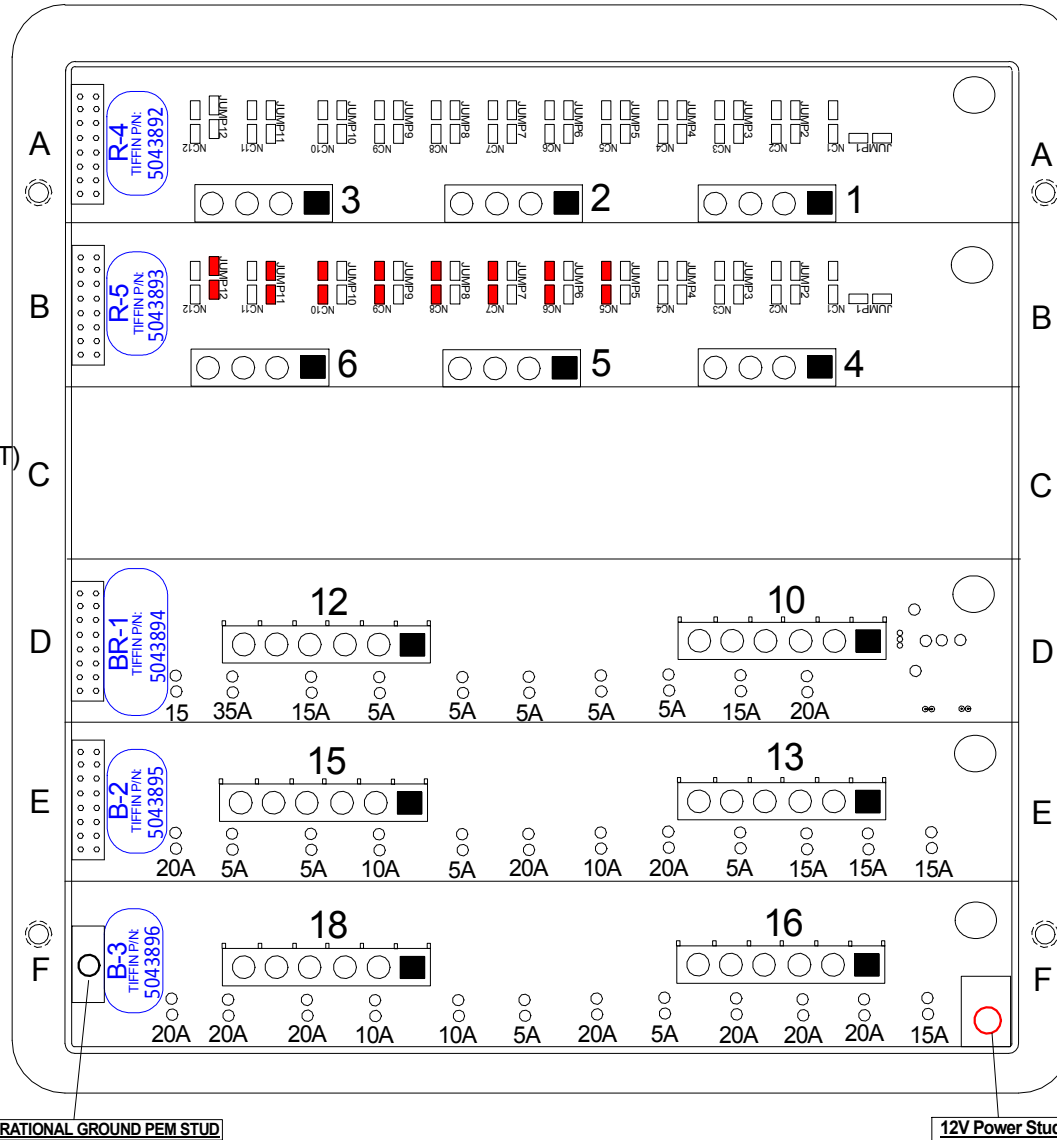

NOTE: CONNECTORS ARE SHOWN HERE IN THE LOADED (REAR) VIEW.

- CONNECTOR 1**
- 1-1 D/S FR SLIDE RET
 - 1-2 D/S FR SLIDE EXT
 - 1-3 P/S FR SLIDE RET
 - 1-4 P/S FR SLIDE EXT

- CONNECTOR 2**
- 2-1 D/S RR SLIDE RET
 - 2-2 D/S RR SLIDE EXT
 - 2-3 P/S RR SLIDE RET
 - 2-4 P/S RR SLIDE EXT

- CONNECTOR 3**
- 3-1 HYDRAULIC PUMP - D/S SLIDE
 - 3-2 HYDRAULIC PUMP - P/S SLIDE
 - 3-3 PORCH/DOOR CONST/UNDCHC
 - 3-4 HYDRA-HOT ENGINE PREHEAT

- CONNECTOR 10**
- 10-1
 - 10-2
 - 10-3 DENSO A/C PWR IGN(YELLOW)
 - 10-4 MIRRORS
 - 10-5 CAMERA IGN
 - 10-6 JACK BUZZER

- CONNECTOR 12**
- 12-1 PANEL LAMP/HEADLT LED
 - 12-2 FRIDGE
 - 12-3 ENTRY STEP IGN
 - 12-4 DOCK LIGHT
 - 12-5 WIPER
 - 12-6 POWER WINDOW OPTION

- CONNECTOR 16**
- 16-1 RADIO MEMORY / XM PWR
 - 16-2 DENSO A/C POWER
 - 16-3 12V+ OUTLET #1
 - 16-4 12V+ OUTLET #2
 - 16-5 ENGINE PREHEAT SWITCH
 - 16-6 HYDRA-HOT (option)

- CONNECTOR 18**
- 18-1 EMS MODULE
 - 18-2 CORD REEL
 - 18-3 HOSE REEL
 - 18-4 FRONT SLIDE MODULE
 - 18-5 VANITY SLIDE MODULE
 - 18-6 BED SLIDE MODULE

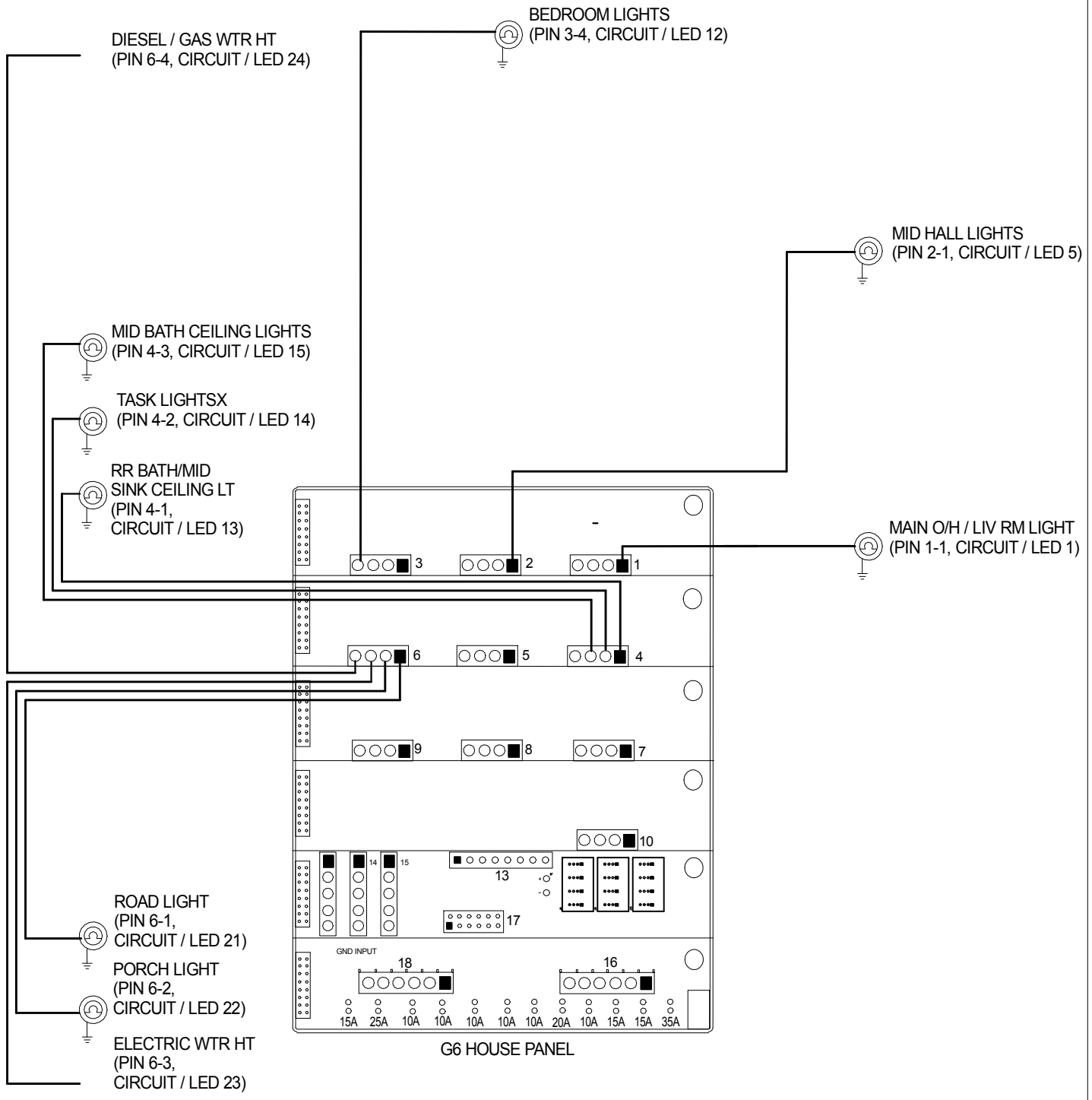

DESC. G6 HOUSE PANEL LIGHTS	
DESIGN FOR: TIFFIN RED	TYPE: ELECTRICAL DRAWING
REV # 1v0	
SPYDER CONTROLS CORP	NOV 03/2014

BREAKER		AMPS
61	MACERATOR TOILET	35
62	FRONT FURNANCE	15
63	REAR FURNACE	15
64	SWITCHER/LP/IR REPEATER	10
65	OUTSIDE TV OUTLET	20
66	BRKR TO FR SLIDES/SHADE MODULE	10
67	FRONT THERMO	10
68	MID THERMO	10
69	TOILET/REAR THERMO	10
70	BRKR TO RR SLIDES	10
71	FRIDGE	25
72		15

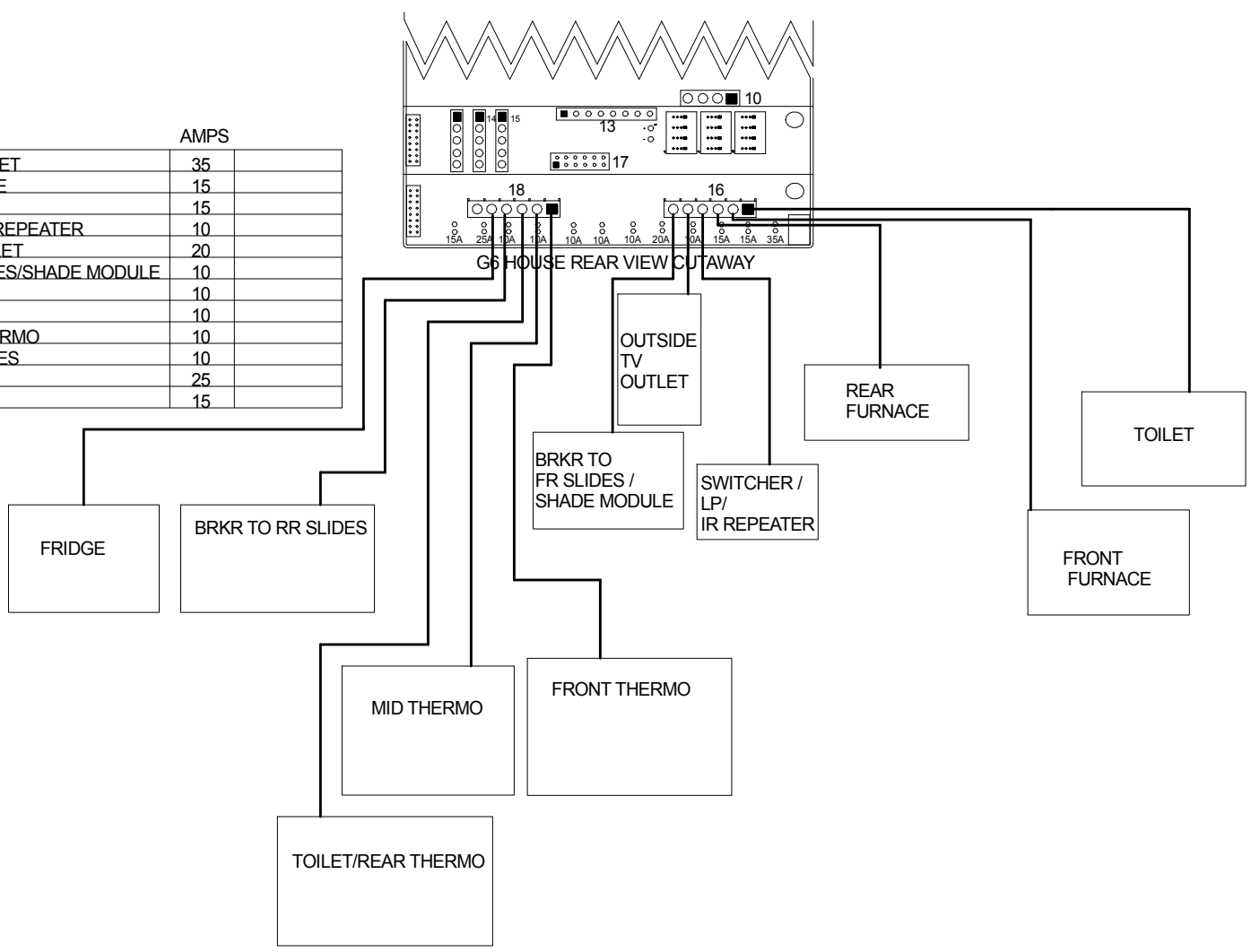

DESC. G6 HOUSE PANEL BREAKERS	
DESIGN FOR: TIFFIN BUS/PHTN	TYPE: ELECTRICAL DRAWING
REV # 1v0	
SPYDER CONTROLS CORP	OCT 02/2014

		AMPS	
BREAKER MODULE (IGN)	37		
	38		
	39	DENSO A/C POWER IGNITION	20
	40	MIRRORS	15
	41	CAMERA IGN	5
	42	JACK BUZZER	5
	43	PANEL LAMP / HDLT	5
	44	FRIDGE	5
BREAKER	45	ENTRY STEP IGN	5
	46		15
	47		35
	48	POWER WINDOW OPTION	15
	49	MAP LT / RADIO / FANS	15
	50	USB POWER	15
	51		15
	52	ENTRY STEP SWITCH	5
	53	ENTRY STEP POWER	20
	54	CARGO LIGHTS (CONSTANT)	10
BREAKER	55	POWER SEAT #1	20
	56		5
	57		10
	58	SATELITE	5
	59		5
	60	POWER SEAT #2	20
	61	RADIO MEMORY / XM POWER	15
	62	DENSO A/C POWER	20
	63	12V+ OUTLET #1	20
	64	12V+ OUTLET #2	20
	65		5
	66		10
	67		5
	68		10
69		10	
70	FRONT SLIDE-OUT MODULE	20	
71	VANITY SLIDE MODULE	20	
72	BED SLIDE MODULE	20	

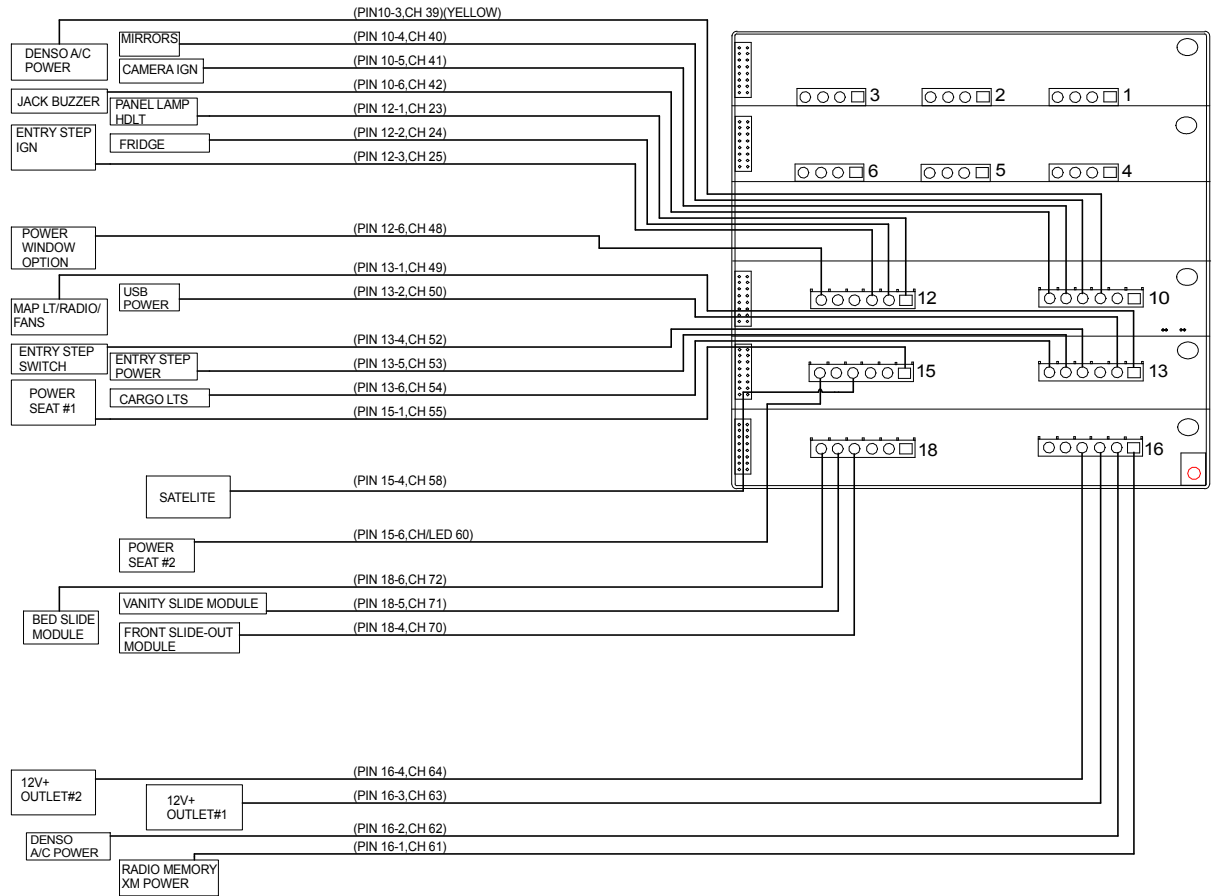

DESC. CHASSIS BREAKER PANEL

DESIGN FOR: TIFFIN RED TYPE: ELECTRICAL DRAWING
 REV #1 1v0

SPYDER CONTROLS CORP NOV 03/2014

G6 CHASSIS PANEL

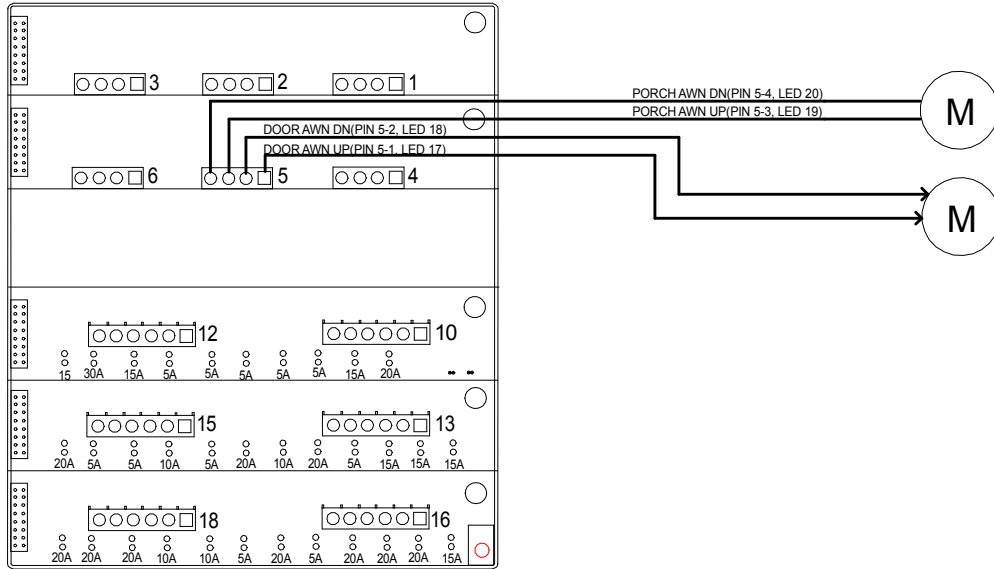

DESC.	SHADES / AWNINGS W/ G6 CHASSIS AND SHADE CONTROL MODULE		
DESIGN FOR:	TIFFIN RED	TYPE:	ELECTRICAL DRAWING
REV #	1v0		
SPYDER CONTROLS CORP	NOV 03/2014		

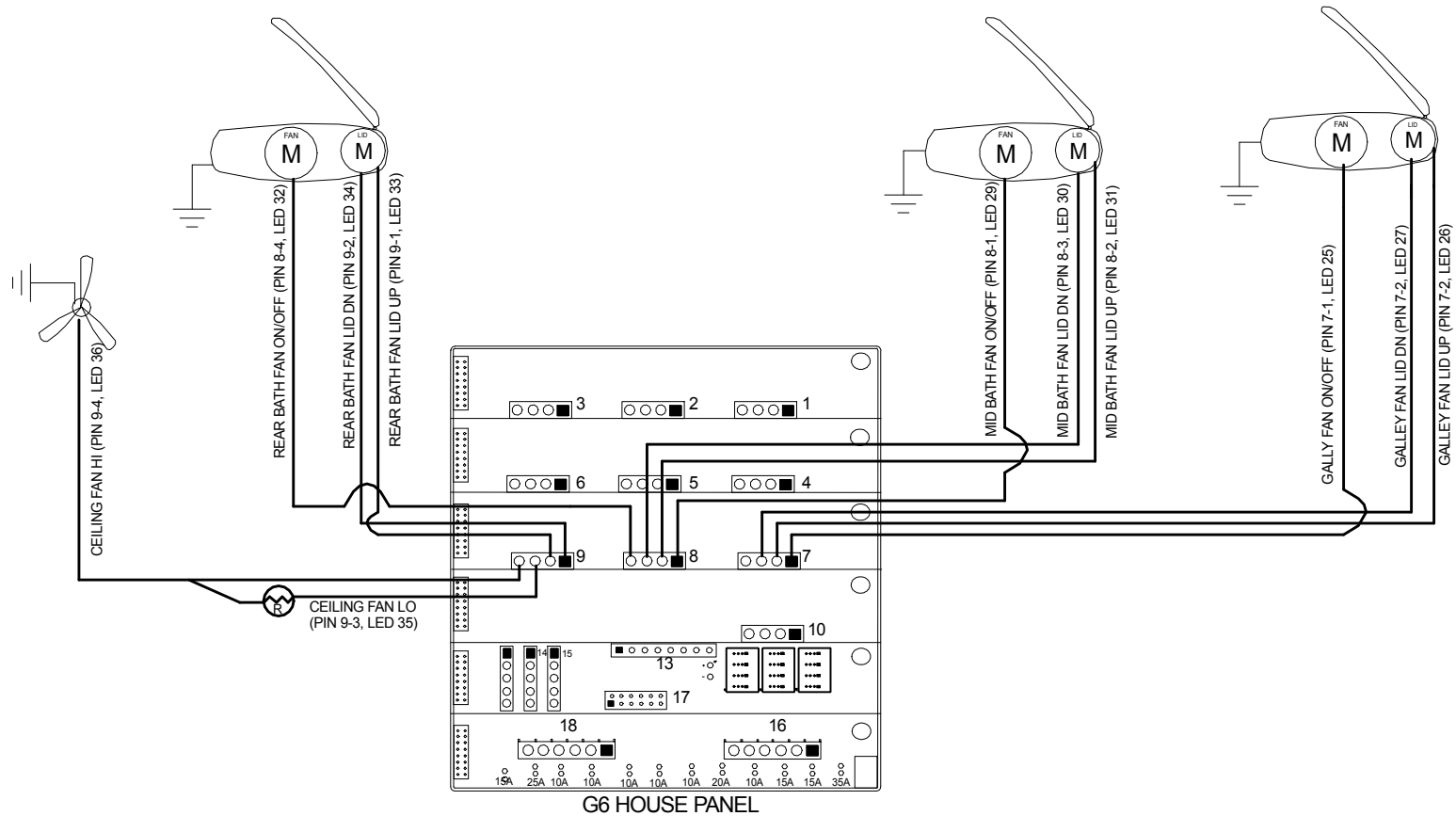

DESC.	HOUSE FANS	
DESIGN FOR:	TIFFIN BUS/PHTN/RED	TYPE: ELECTRICAL DRAWING
REV #	1v0	
SPYDER CONTROLS CORP	NOV 03/2014	

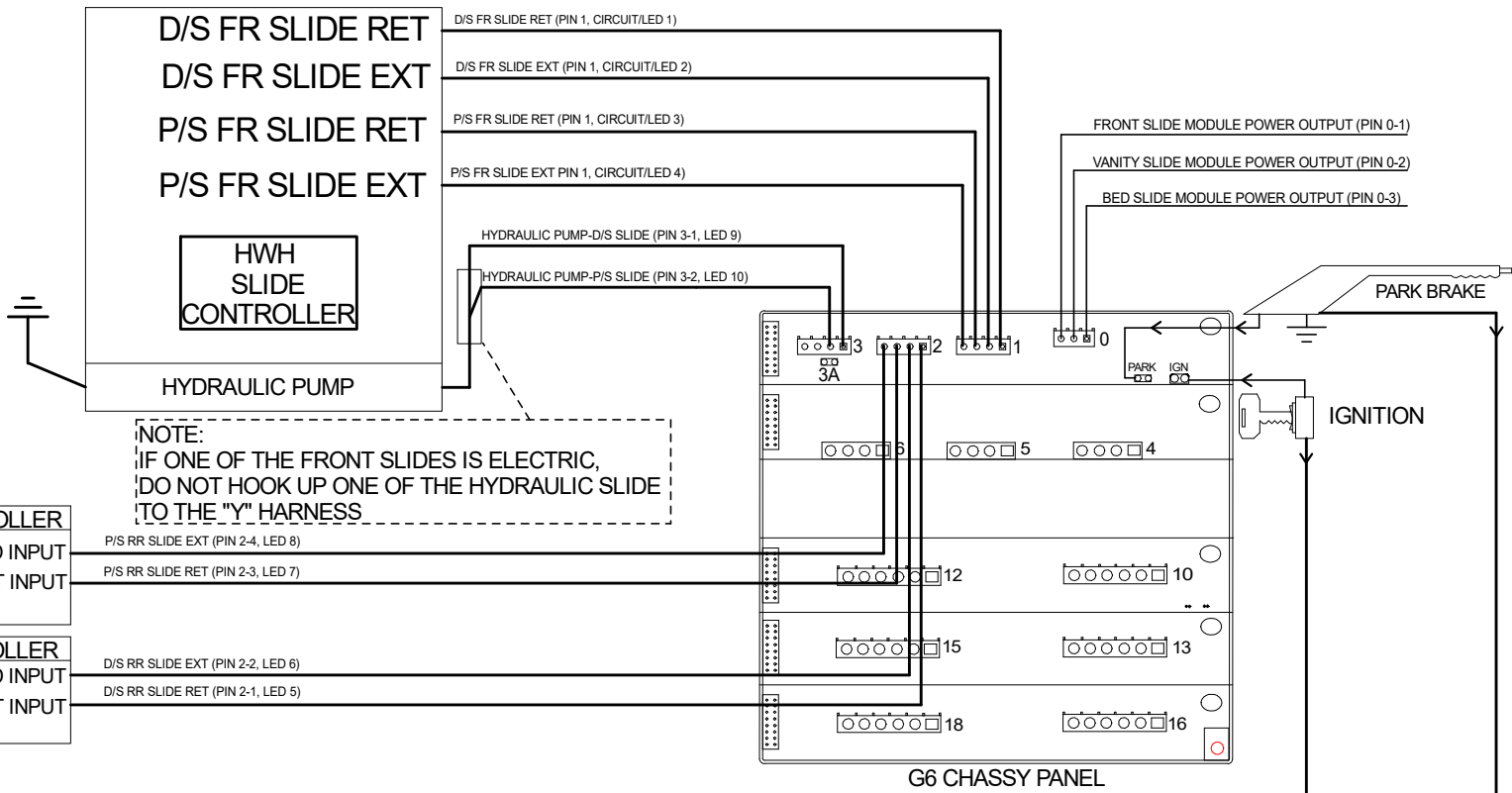

NOTE:
IF ONE OF THE FRONT SLIDES IS ELECTRIC,
DO NOT HOOK UP ONE OF THE HYDRAULIC SLIDE
TO THE "Y" HARNESS

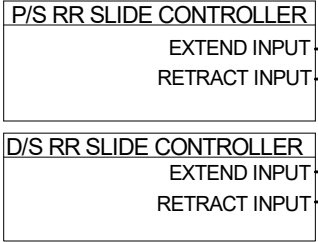

P/S RR SLIDE EXT (PIN 2-4, LED 8)

P/S RR SLIDE RET (PIN 2-3, LED 7)

D/S RR SLIDE EXT (PIN 2-2, LED 6)

D/S RR SLIDE RET (PIN 2-1, LED 5)

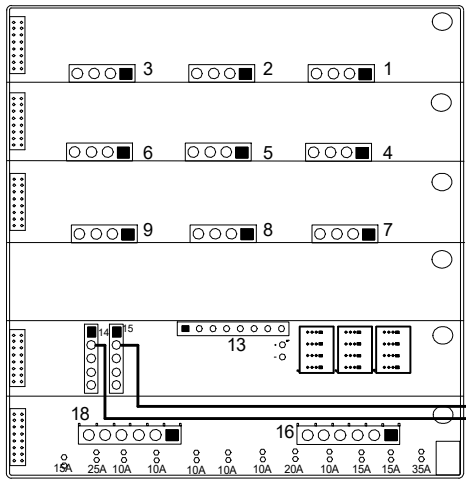
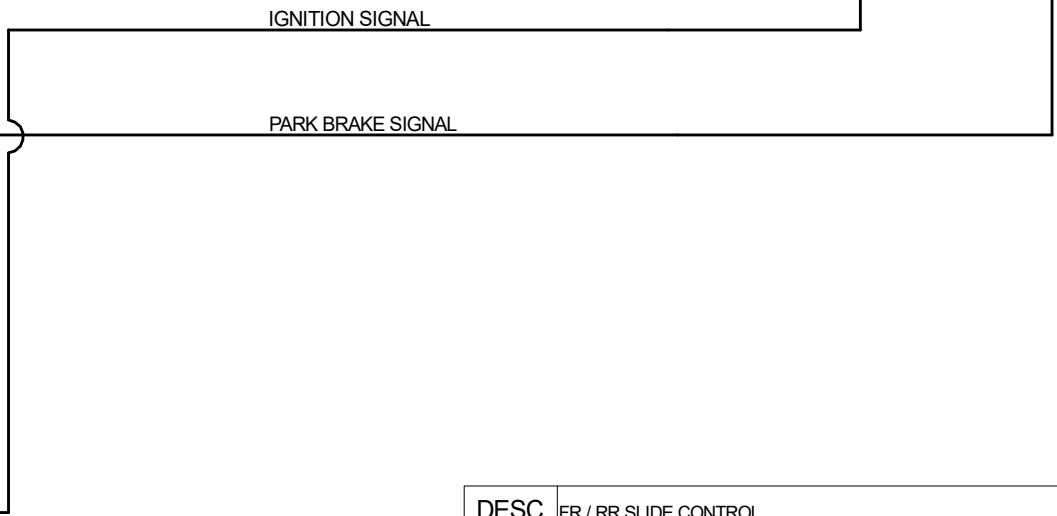

DESC.	FR / RR SLIDE CONTROL	
DESIGN FOR:	TIFFIN RED	TYPE: ELECTRICAL DRAWING
REV #	1v1	
SPYDER CONTROLS CORP	OCT 15/2015	

DRIVERS O/H SWITCH PANEL

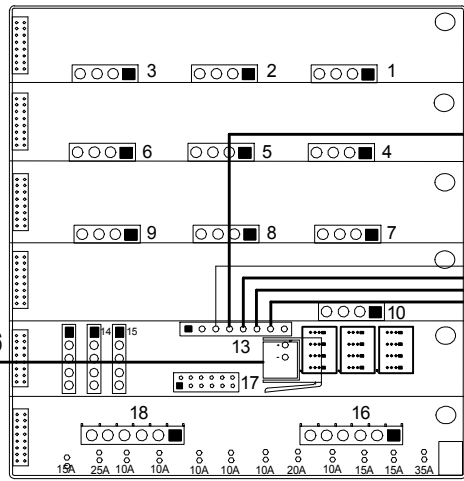

LPG (PIN 13-4)

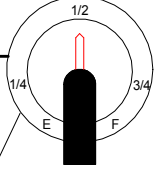

RVC INPUT TO THE G6

COMMON GND FROM G6 PANEL ONLY

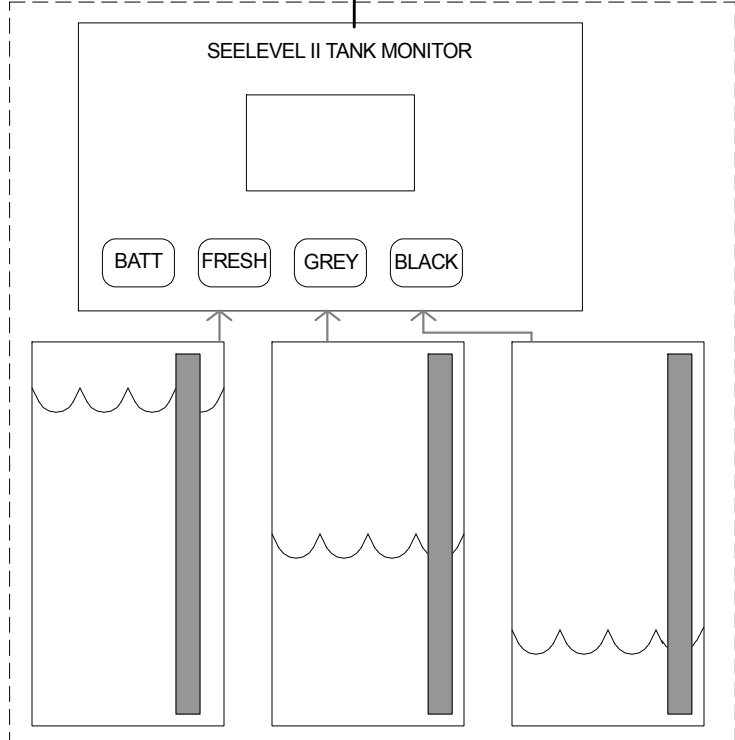

SEELEVEL II TANK MONITOR

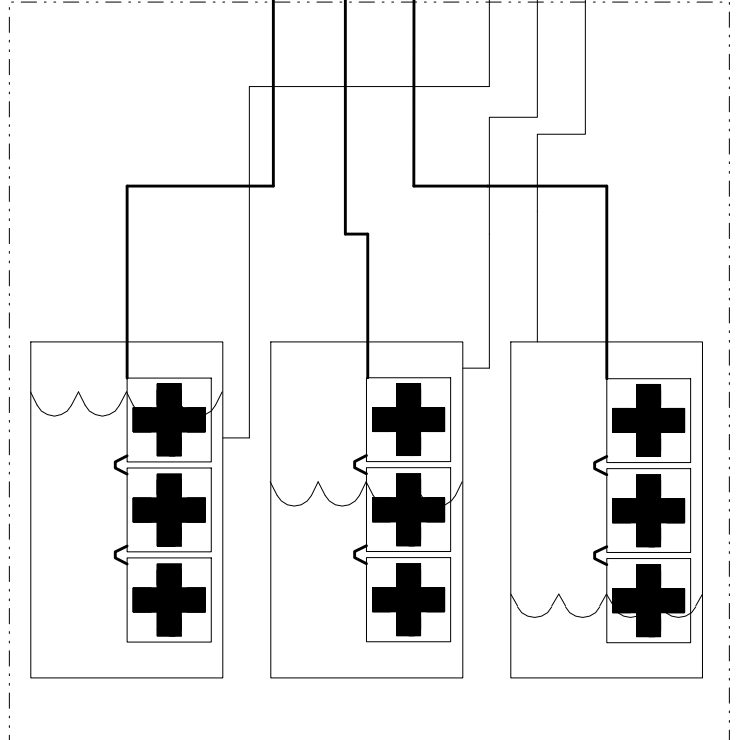

PHEATON, RED TANK MONITOR SYSTEM

DESC.	TANK MONITORING SYSTEM
DESIGN FOR:	TIFFIN BUS/PHTN/RED TYPE: ELECTRICAL DRAWING
REV #	1v0
SPYDER CONTROLS CORP	NOV 03/2014

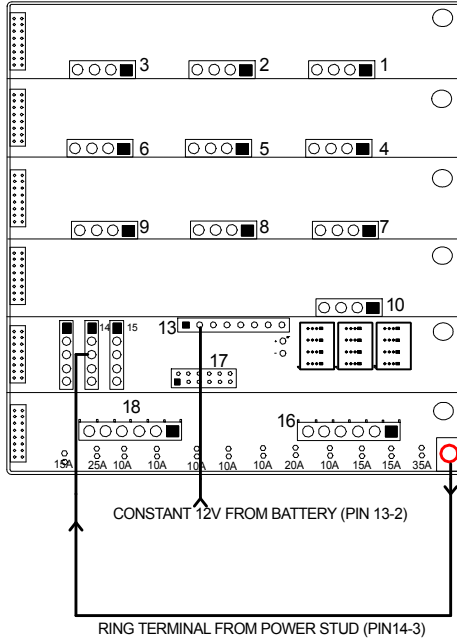

DESC. BATTERY DISCONNECT	
DESIGN FOR: TIFFIN BUS/PHTN/RED	TYPE: ELECTRICAL DRAWING
REV # 1v0	
SPYDER CONTROLS CORP	DEC 09/2014