











Multiplex Integration Schematic

2020 Wayfarer

Schematic Connections Legend	
 Constant Ground	 Reverse Polarity
 Constant 12V+	 Signal
 Switched Ground	 120 VAC Line
 Switched 12V+	 Network Cable

G6 House PANEL @ Foot of The Bed
Tiffin PN: 5070053

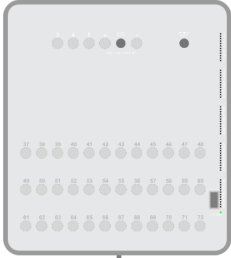

Bedroom
SSP-17

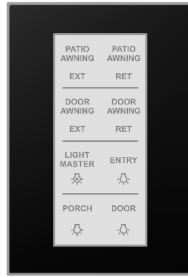

2020 Tiffin Wayfarer General Component Locations Diagram

(Components not to scale)

5" Color Screen
Tiffin PN: 5083677

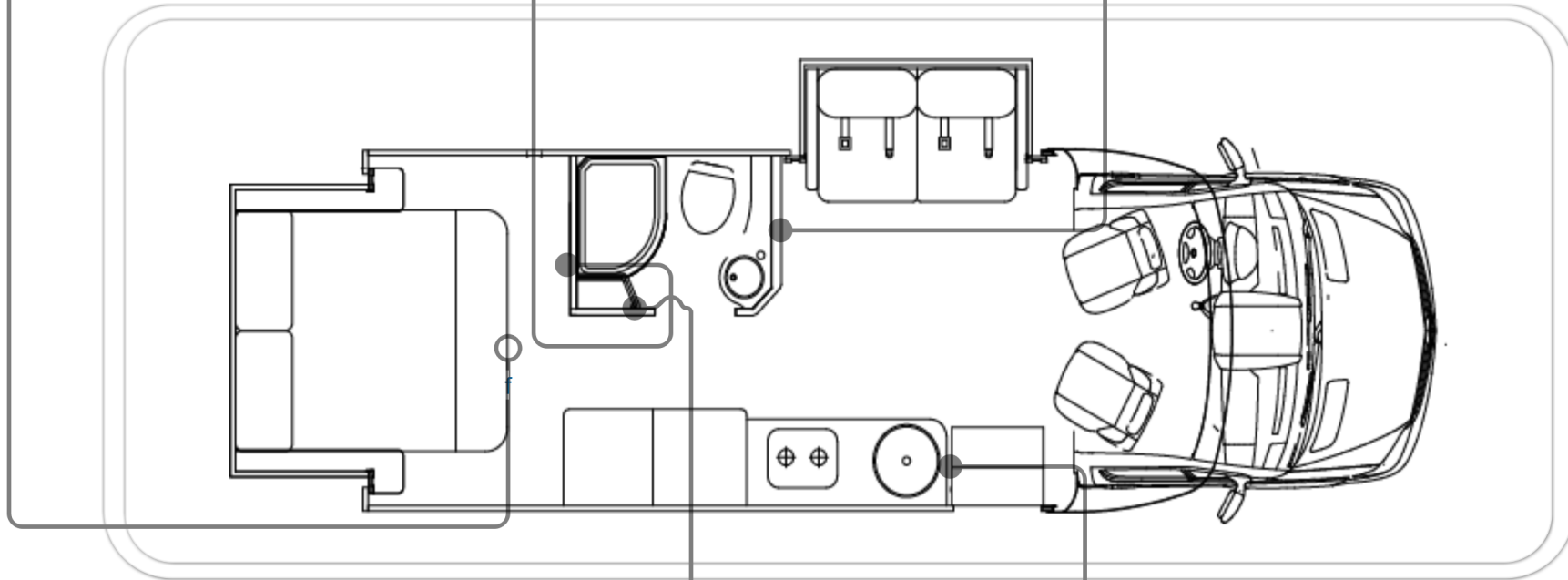

Bathroom
SSP-17

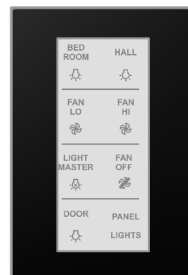

Entry SSP-17

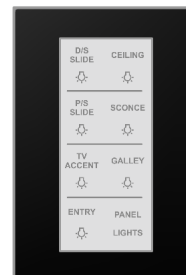

Module located on exterior or under coach bay

Module located inside the coach

2020 Tiffin Wayfarer

G6 Pinout

(Components not to scale)

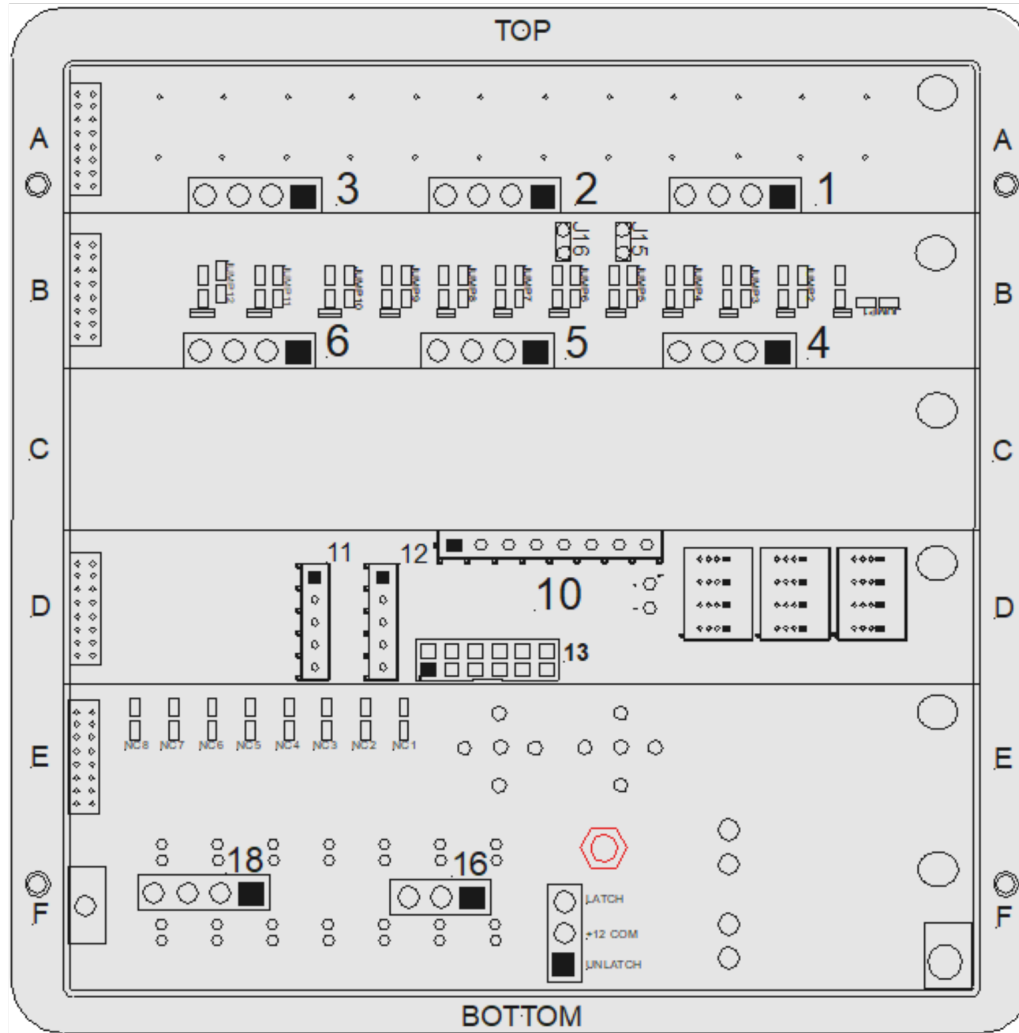

6

- Entry Light (LED 21)
- Tank Heat 1 & 2 (LED 22)
- Cargo Light (G6 LED 23)
- Shower Light (G6 LED 24)

- 1
- 2
- 3
- 4

10

- Unused
- Gen Run Status
- Ground (Common for Sensors)
- LPG Sensor Input
- Black Tank Sensor Input
- Grey Tank Sensor Input
- Fresh Tank Sensor Input
- Unused

- 1
- 2
- 3
- 4
- 5
- 6
- 7
- 8

11

- Water Heater Status
- Ignition
- Unused
- Unused
- Unused

- 1
- 2
- 3
- 4
- 5

12

- Water Pump
- Park Brake
- Unused
- Unused
- Unused

- 1
- 2
- 3
- 4
- 5

18

- Sofa Schwintek Slide (20 Amp)
- Bed Schwintek Slide (20 Amp)
- Furnace (15 Amp)
- Night Stand USB (10 Amp)

- 4
- 3
- 2
- 1

16

- Wireless SW Panels (5 Amp)
- Awning Power (20 Amp)
- Vent Fan (20 Amp)

- 3
- 2
- 1

1

- Main O/H / Liv Rm Light (LED 1)
- Bedroom Lights (LED 2)
- Bathroom Lights (LED 3)
- Task Lights (LED 4)

- 1
- 2
- 3
- 4

2

- Sofa Reading Lights (LED 5)
- Bed Reading Lights (LED 6)
- Bathroom Lights (LED 7)
- Task Lights (LED 8)

- 1
- 2
- 3
- 4

3

- Sofa Slide EXT (LED 9)
- Sofa Slide RET (LED 10)
- Bed Slide EXT (LED 11)
- Bed Slide RET (LED 12)

- 1
- 2
- 3
- 4

4

- Water Pump (LED 13)
- Awning LT (LED 14)
- Porch LT (LED 15)
- Hall Lights (LED 16)

- 1
- 2
- 3
- 4

5

- Awning EXT (LED 17)
- Awning RET (LED 18)
- Elec Water HT (LED 19)
- Gas Water HT (LED 20)

- 1
- 2
- 3
- 4

2020 Tiffin Wayfarer Switch and Screen Network (Components not to scale)

G6 Panel
@ Foot of Bed
Tiffin P/N: 5070053

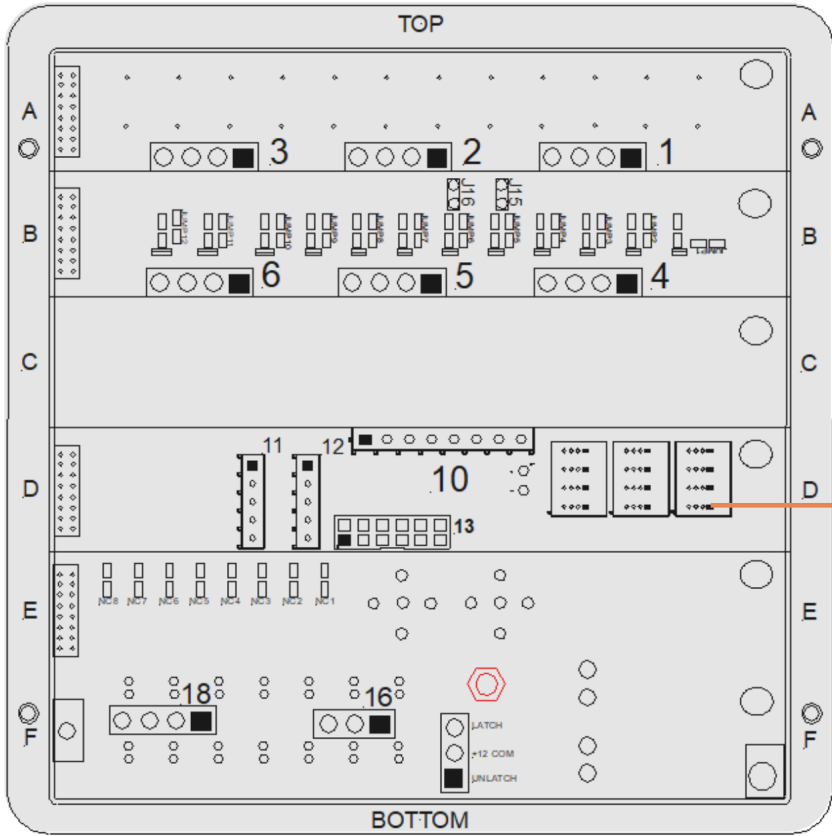

5" Color Screen



Bedroom

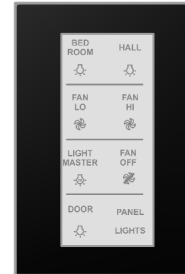

Bath

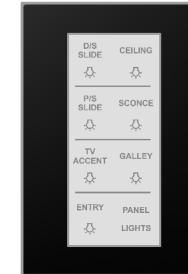

Entry

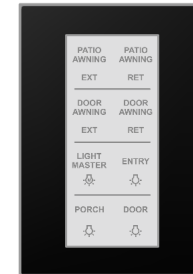

If a switch or module has the symbol above near it, it means that switch or module communicates via RF.

2020 Tiffin Wayfarer Slide System (Components not to scale)



Park brake and ignition must be on for slides to operate.
In case of a system failure, use manual overrides on front of G6 Chassis panel to operate slides. Engage overrides using a pen or other pointed object.

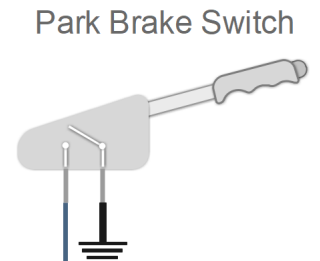
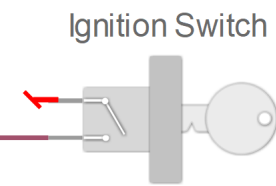
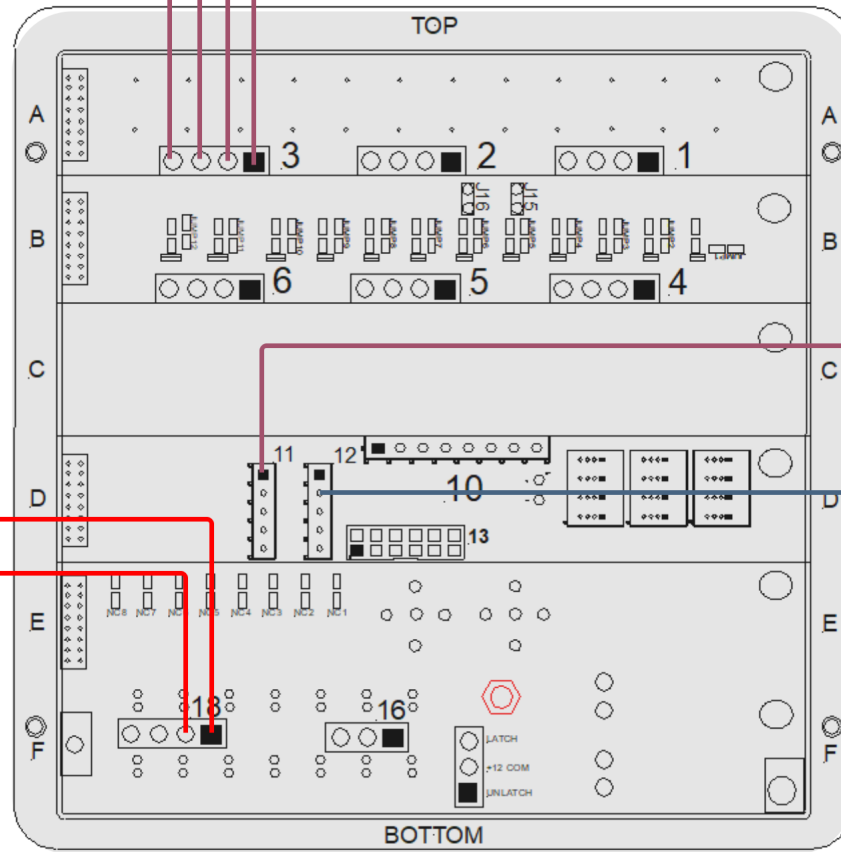

2020 Tiffin Wayfarer
Awning System
(Components not to scale)

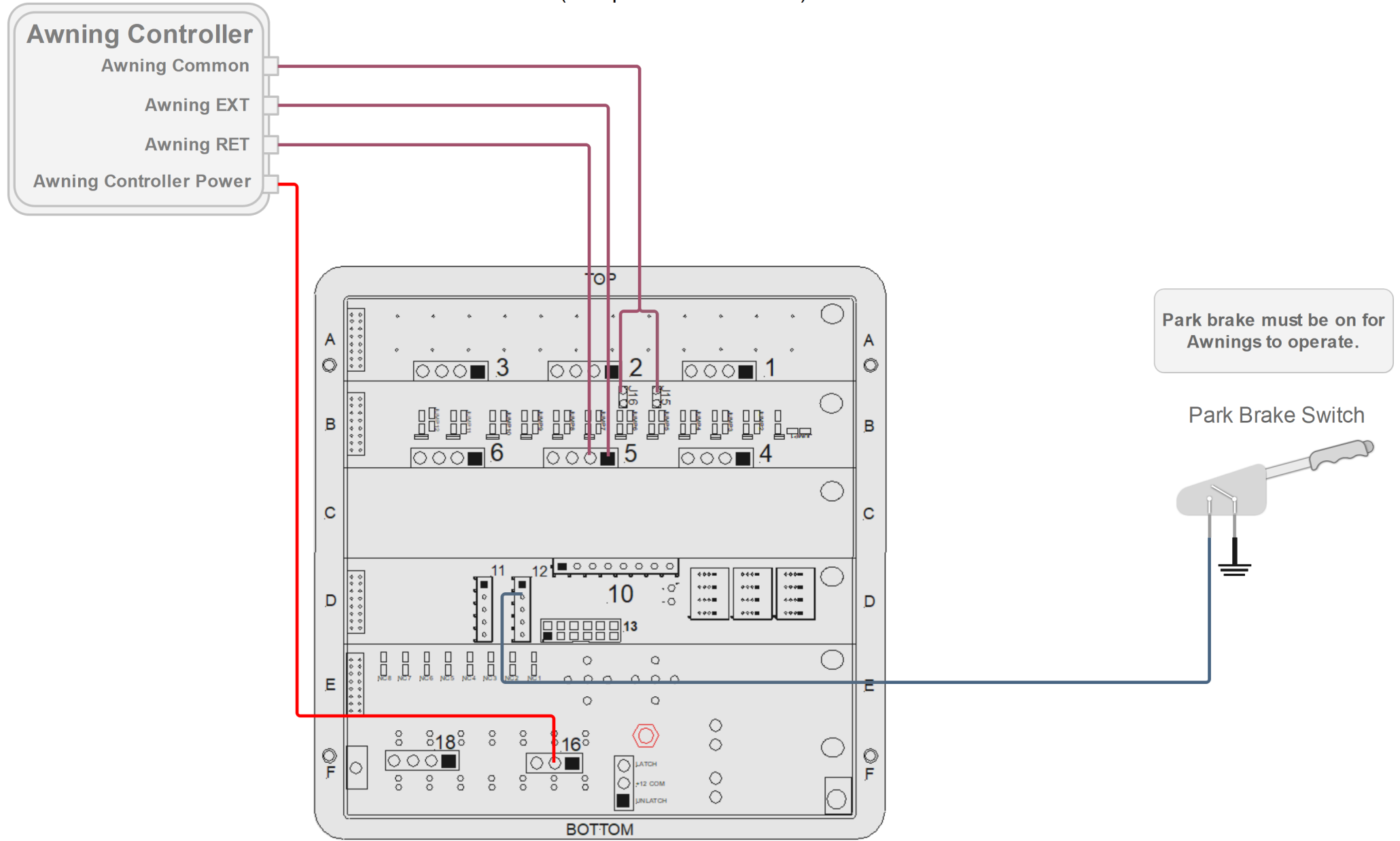

2020 Tiffin Wayfarer Switches

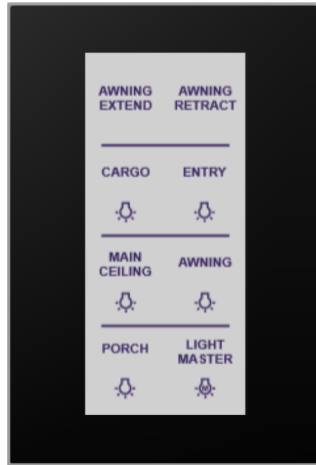

24TW, QW, FW TW,
Entry
Tiffin SW PN: 5067797

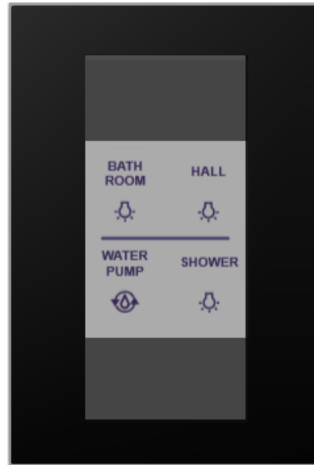

24TW, QW, BW, Bath
w/o WATER HEATER
Tiffin SW PN: 5068658



24BW, QW, Bedroom
Tiffin SW PN: 5080584

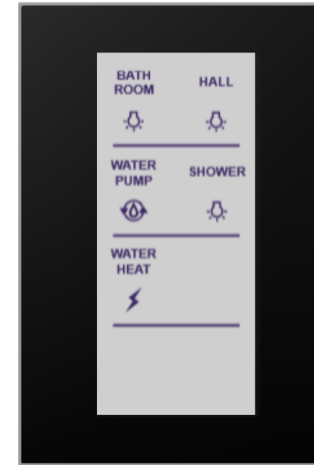

24TW, QW, BW, Bath
w/ WATER HEAT
Tiffin SW PN: 5067796



24TW, Bedroom
Tiffin SW PN:
5067795



TW, BW, QW, FW
5" Color Touch
Screen
Tiffin SW PN: 5083677

2020 Tiffin Wayfarer Tank Level System (Components not to scale)

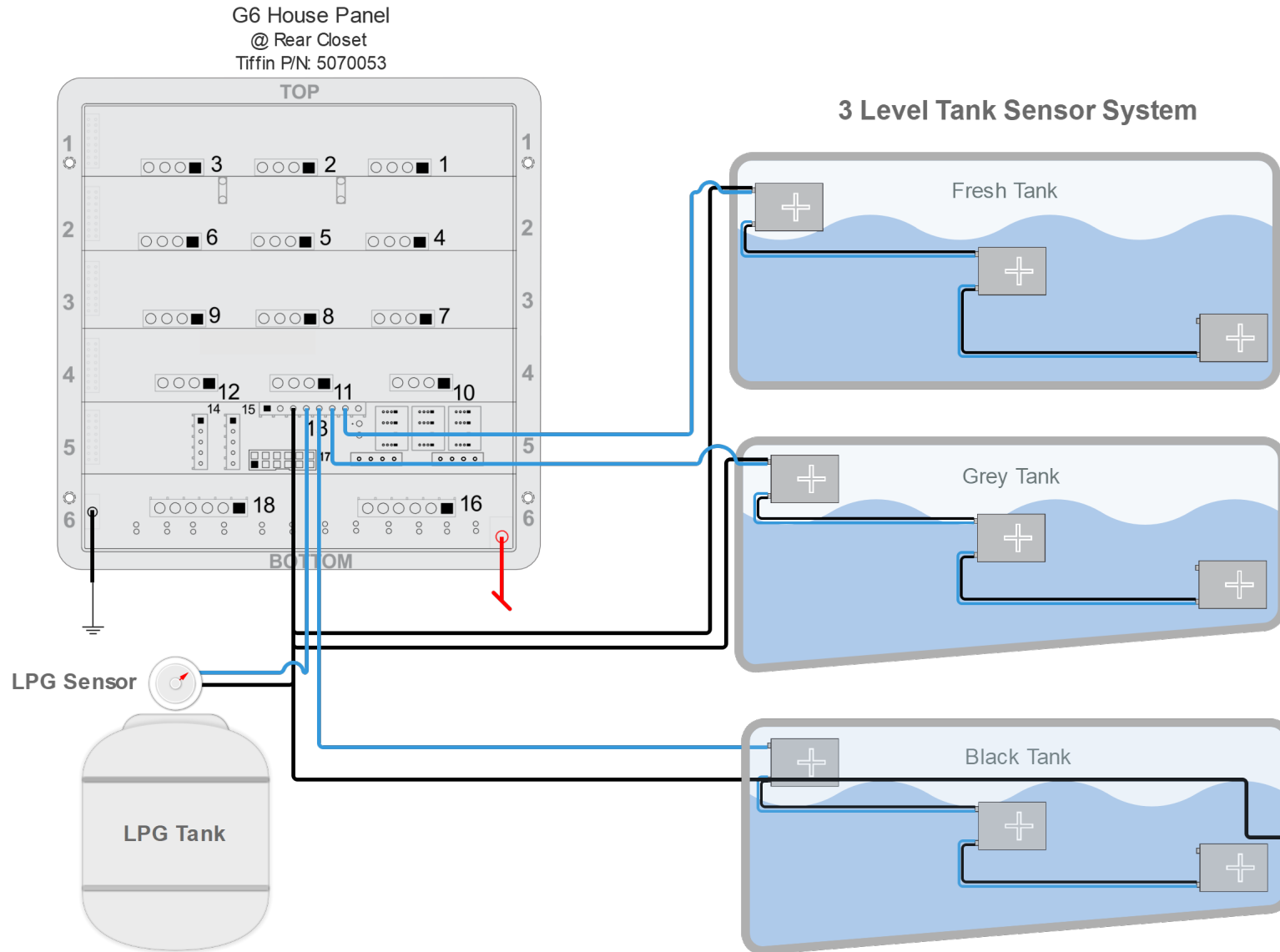

2020 Tiffin Wayfarer Miscellaneous (Components not to scale)

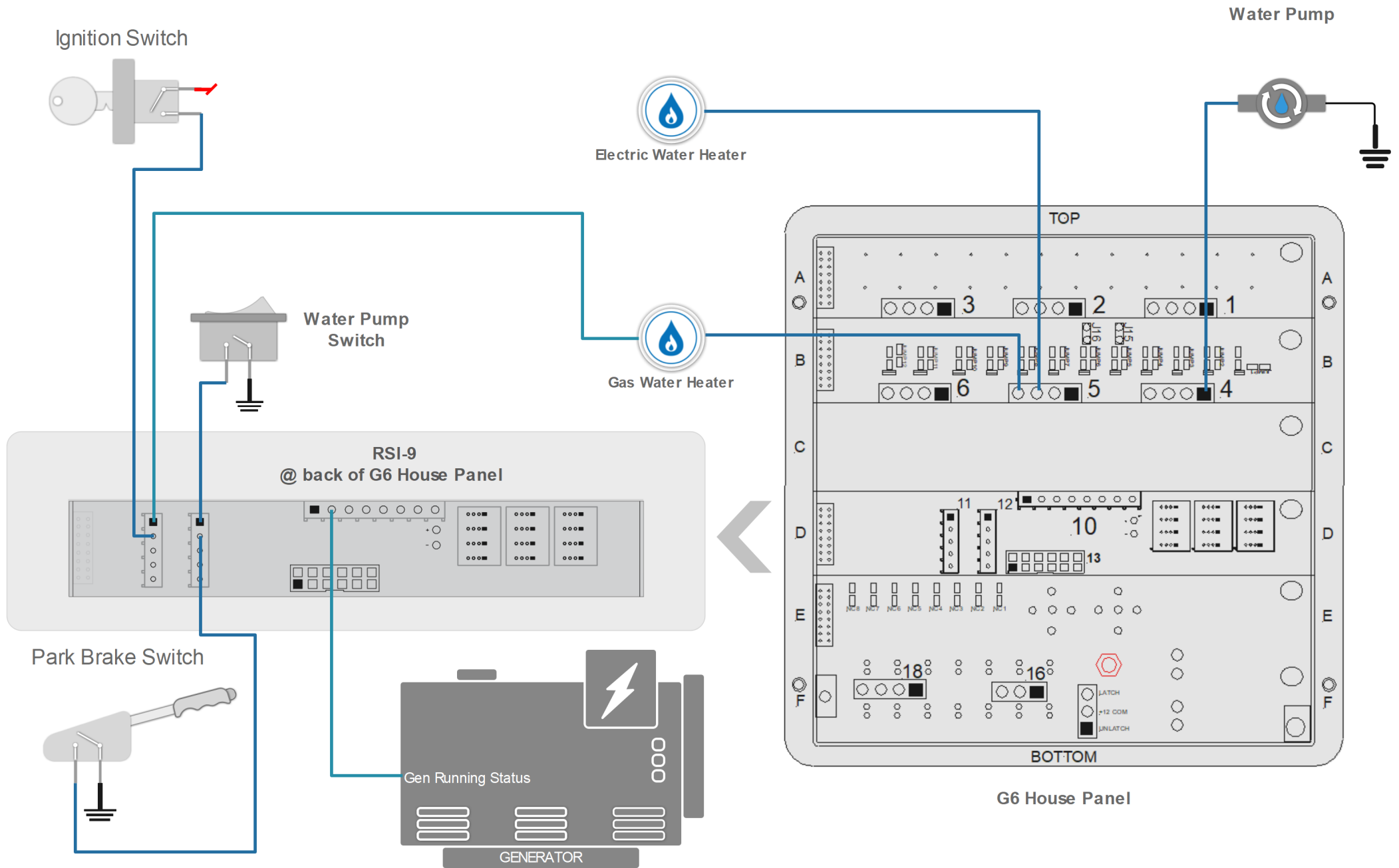

2020 Tiffin Wayfarer

Network Connectors and Related Parts

(Components not to scale)

G3 Terminator Tap
Tiffin P/N: 5051935

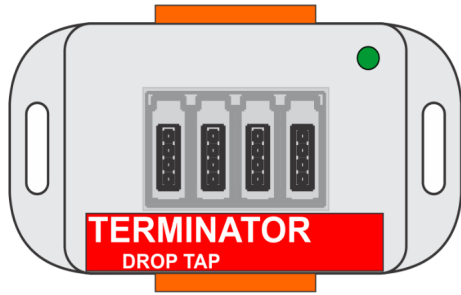

G3 Common Tap
Tiffin P/N: 5027834

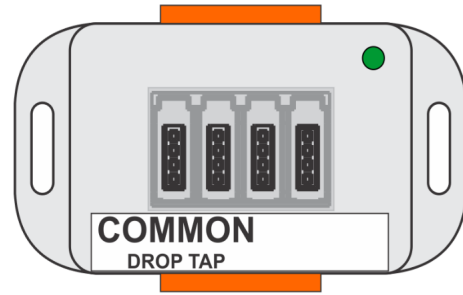

G4 Common Drop Tap
Tiffin P/N: 5016592



Mini-Clamp Plug
Tiffin P/N: 5066157



G4 Terminator Drop Tap
Tiffin P/N: 5051936



Mini-Clamp Socket
Tiffin P/N: 5066158



4 Pos Wago Connector
Tiffin P/N: 5015508

