











# Multiplex Integration Schematic

## 2021 Wayfarer

Schematic Connections Legend			
	Constant Ground		Reverse Polarity
	Constant 12V+		Signal
	Switched Ground		120 VAC Line
	Switched 12V+		Network Cable

G6 House PANEL @ Foot of  
The Bed  
Tiffin PN: 5070053

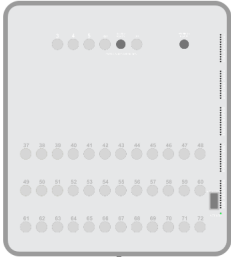

Bedroom  
SSP-17

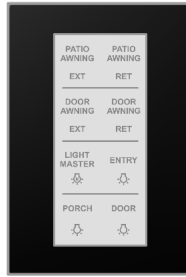

## 2021 Tiffin Wayfarer General Component Locations Diagram

(Components not to scale)

5" Color Screen  
Tiffin PN: 5083677

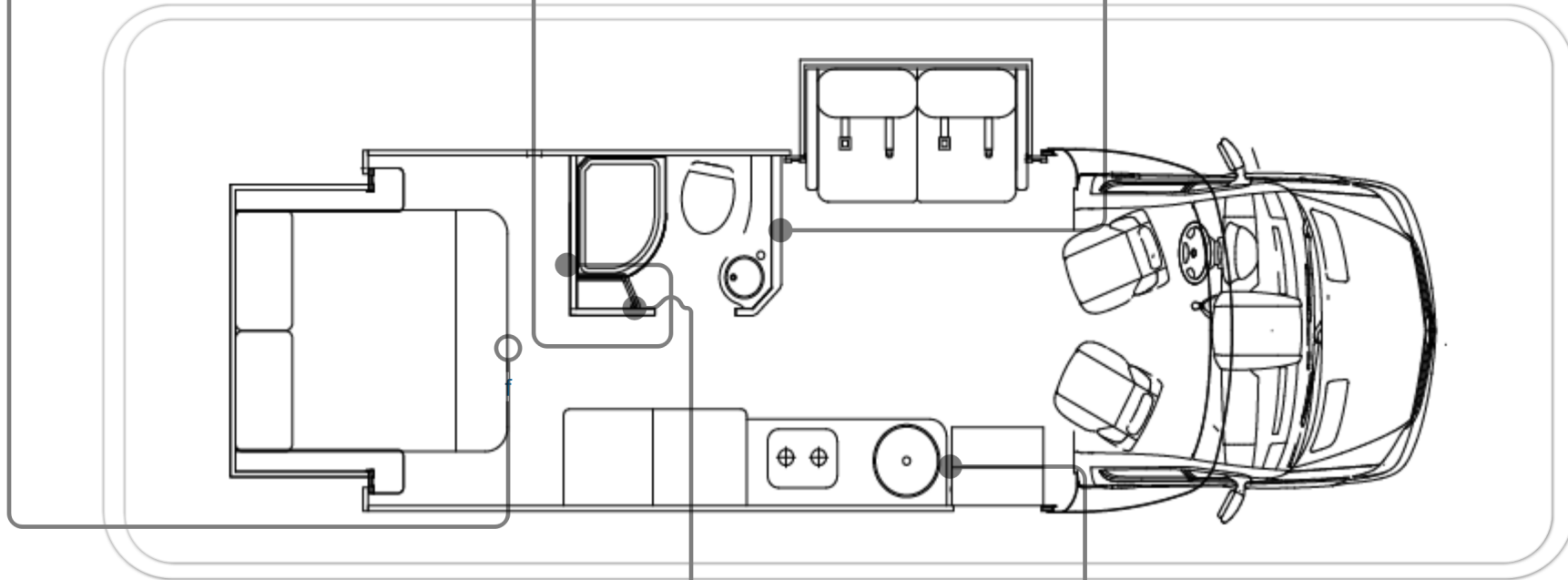

Bathroom  
SSP-17

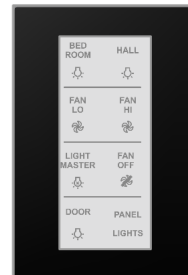

Entry SSP-17

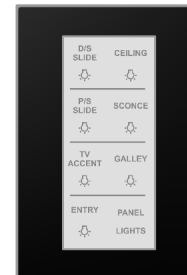

Module located on  
exterior or under —   
coach bay

Module located  
inside the coach —

# 2021 Tiffin Wayfarer

## G6 Pinout

(Components not to scale)

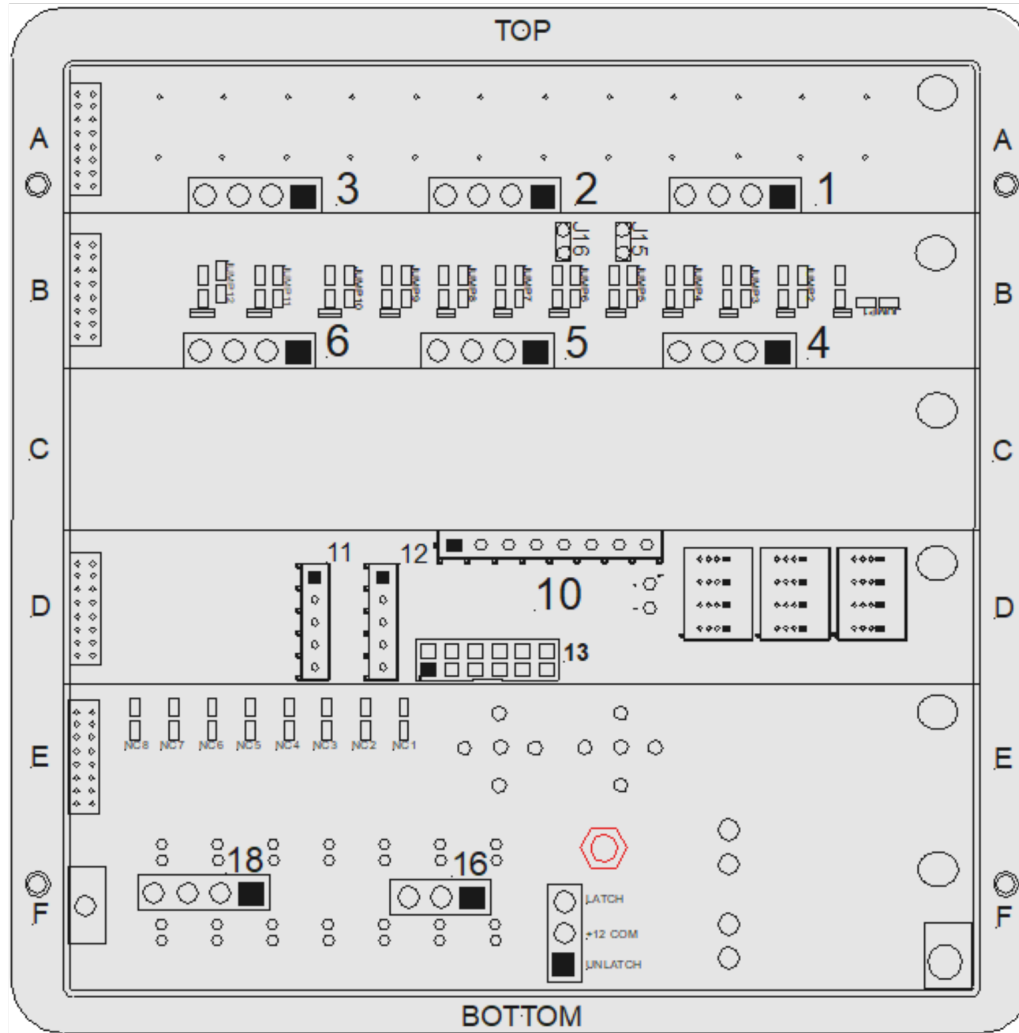

**6**

- 1 Entry Light (LED 21)
- 2 Tank Heat 1 & 2 (LED 22)
- 3 Cargo Light (G6 LED 23)
- 4 Shower Light (G6 LED 24)

- 1
- 2
- 3
- 4

**10**

- 1 Unused
- 2 Gen Run Status
- 3 Ground (Common for Sensors)
- 4 LPG Sensor Input
- 5 Black Tank Sensor Input
- 6 Grey Tank Sensor Input
- 7 Fresh Tank Sensor Input
- 8 Unused

- 1
- 2
- 3
- 4
- 5
- 6
- 7
- 8

**11**

- 1 Water Heater Status
- 2 Ignition
- 3 Unused
- 4 Unused
- 5 Unused

- 1
- 2
- 3
- 4
- 5

**12**

- 1 Water Pump
- 2 Park Brake
- 3 Unused
- 4 Unused
- 5 Unused

- 1
- 2
- 3
- 4
- 5

**18**

- 1 Sofa Schwintek Slide (20 Amp)
- 2 Bed Schwintek Slide (20 Amp)
- 3 Furnace (15 Amp)
- 4 Night Stand USB (10 Amp)

- 4
- 3
- 2
- 1

**16**

- 1 Wireless SW Panels (5 Amp)
- 2 Awning Power (20 Amp)
- 3 Vent Fan (20 Amp)

- 3
- 2
- 1

**1**

- 1 Main O/H / Liv Rm Light (LED 1)
- 2 Bedroom Lights (LED 2)
- 3 Bathroom Lights (LED 3)
- 4 Task Lights (LED 4)

- 1
- 2
- 3
- 4

**2**

- 1 Sofa Reading Lights (LED 5)
- 2 Bed Reading Lights (LED 6)
- 3 Bathroom Lights (LED 7)
- 4 Task Lights (LED 8)

- 1
- 2
- 3
- 4

**3**

- 1 Sofa Slide EXT (LED 9)
- 2 Sofa Slide RET (LED 10)
- 3 Bed Slide EXT (LED 11)
- 4 Bed Slide RET (LED 12)

- 1
- 2
- 3
- 4

**4**

- 1 Water Pump (LED 13)
- 2 Awning LT (LED 14)
- 3 Porch LT (LED 15)
- 4 Hall Lights (LED 16)

- 1
- 2
- 3
- 4

**5**

- 1 Awning EXT (LED 17)
- 2 Awning RET (LED 18)
- 3 Elec Water HT (LED 19)
- 4 Gas Water HT (LED 20)

- 1
- 2
- 3
- 4

# 2021 Tiffin Wayfarer Switch and Screen Network (Components not to scale)

G6 Panel  
@ Foot of Bed  
Tiffin P/N: 5070053

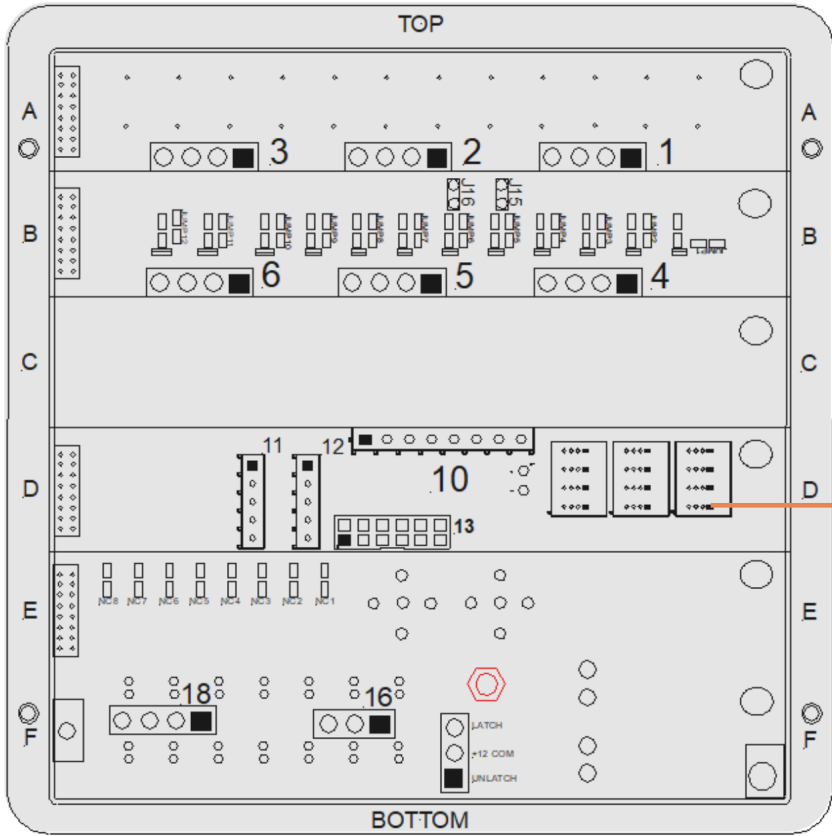

5" Color Screen



Bedroom

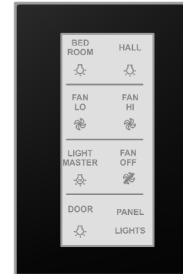

Bath

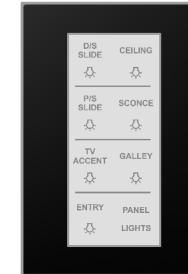

Entry

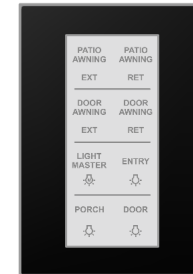

If a switch or module has the symbol above near it, it means that switch or module communicates via RF.

# 2021 Tiffin Wayfarer Slide System (Components not to scale)



Park brake and ignition must be on for slides to operate.  
In case of a system failure, use manual overrides on front of G6 Chassis panel to operate slides. Engage overrides using a pen or other pointed object.

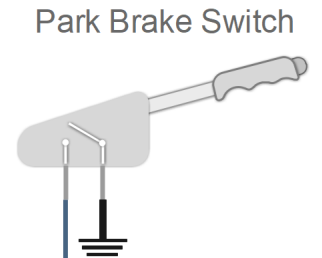
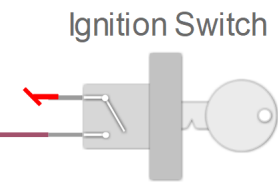
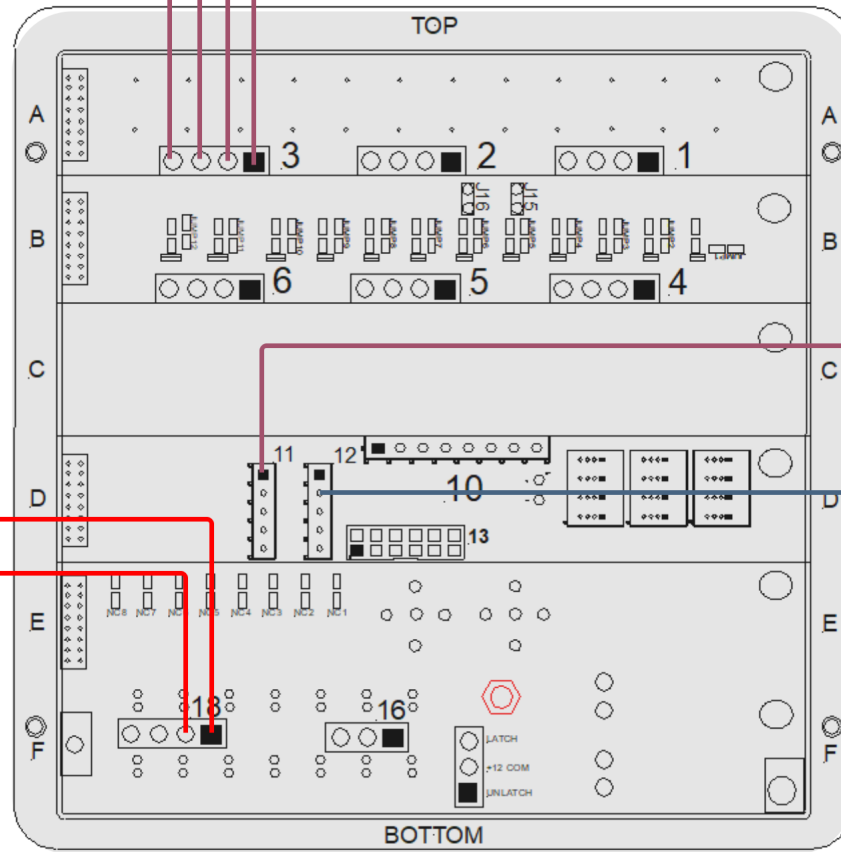

2021 Tiffin Wayfarer  
Awning System  
(Components not to scale)

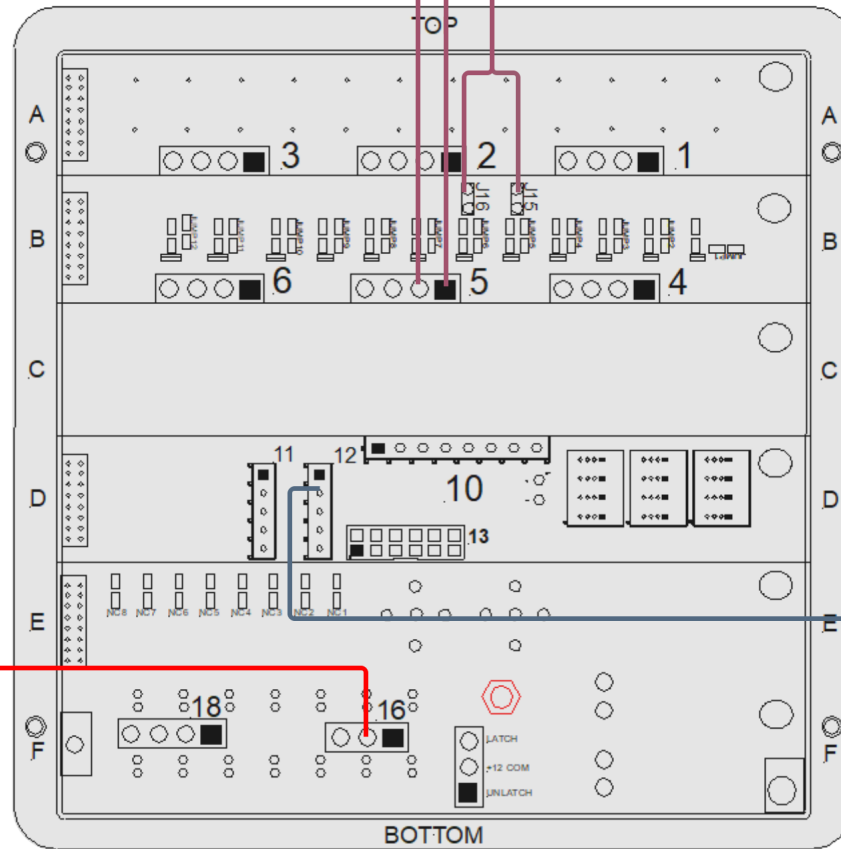
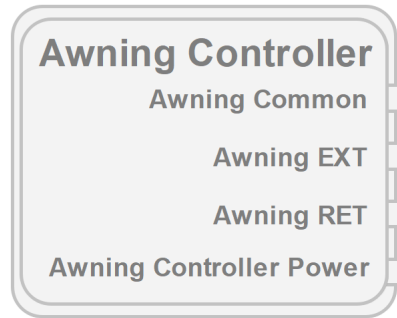

Park brake must be on for  
Awnings to operate.

Park Brake Switch

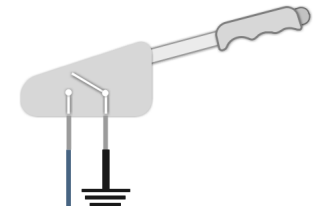

## 2021 Tiffin Wayfarer Switches

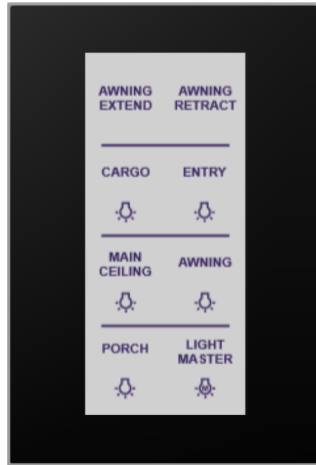

24TW, QW, FW TW,  
Entry  
Tiffin SW PN: 5067797

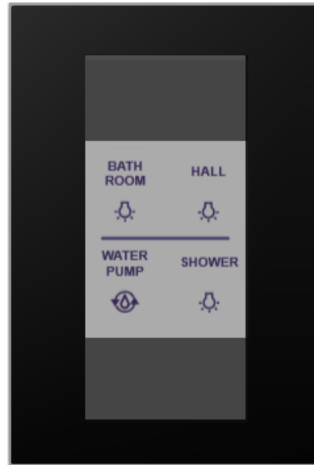

24TW, QW, BW, Bath  
w/o WATER HEATER  
Tiffin SW PN: 5068658



24BW, QW, Bedroom  
Tiffin SW PN: 5080584

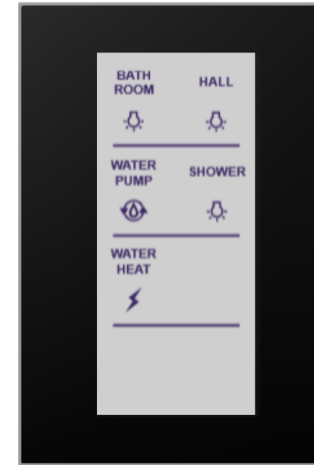

24TW, QW, BW, Bath  
w/ WATER HEAT  
Tiffin SW PN: 5067796



24TW, Bedroom  
Tiffin SW PN:  
5067795



TW, BW, QW, FW  
5" Color Touch  
Screen  
Tiffin SW PN: 5083677

# 2021 Tiffin Wayfarer Tank Level System (Components not to scale)

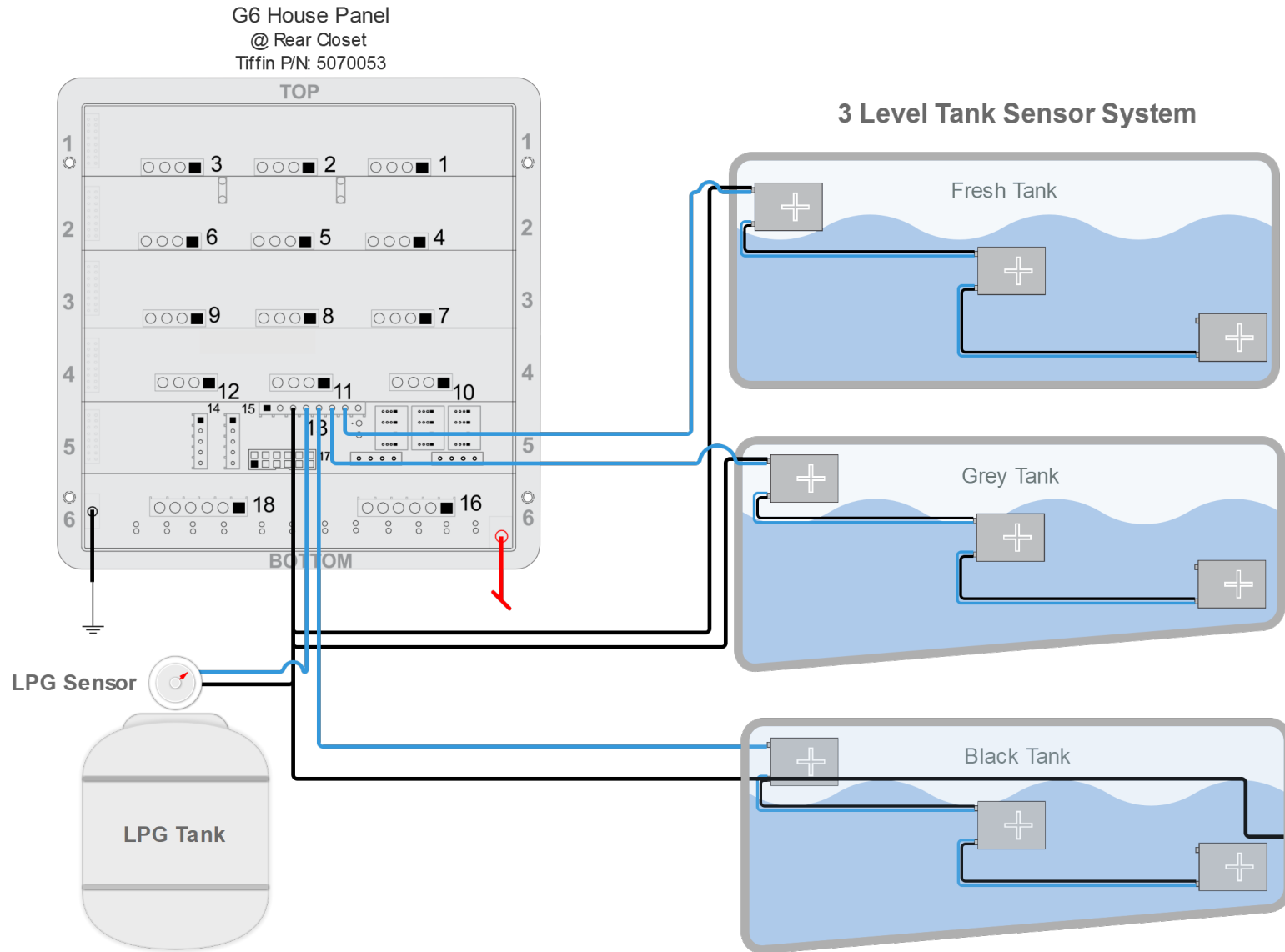

2021 Tiffin Wayfarer  
Miscellaneous  
(Components not to scale)

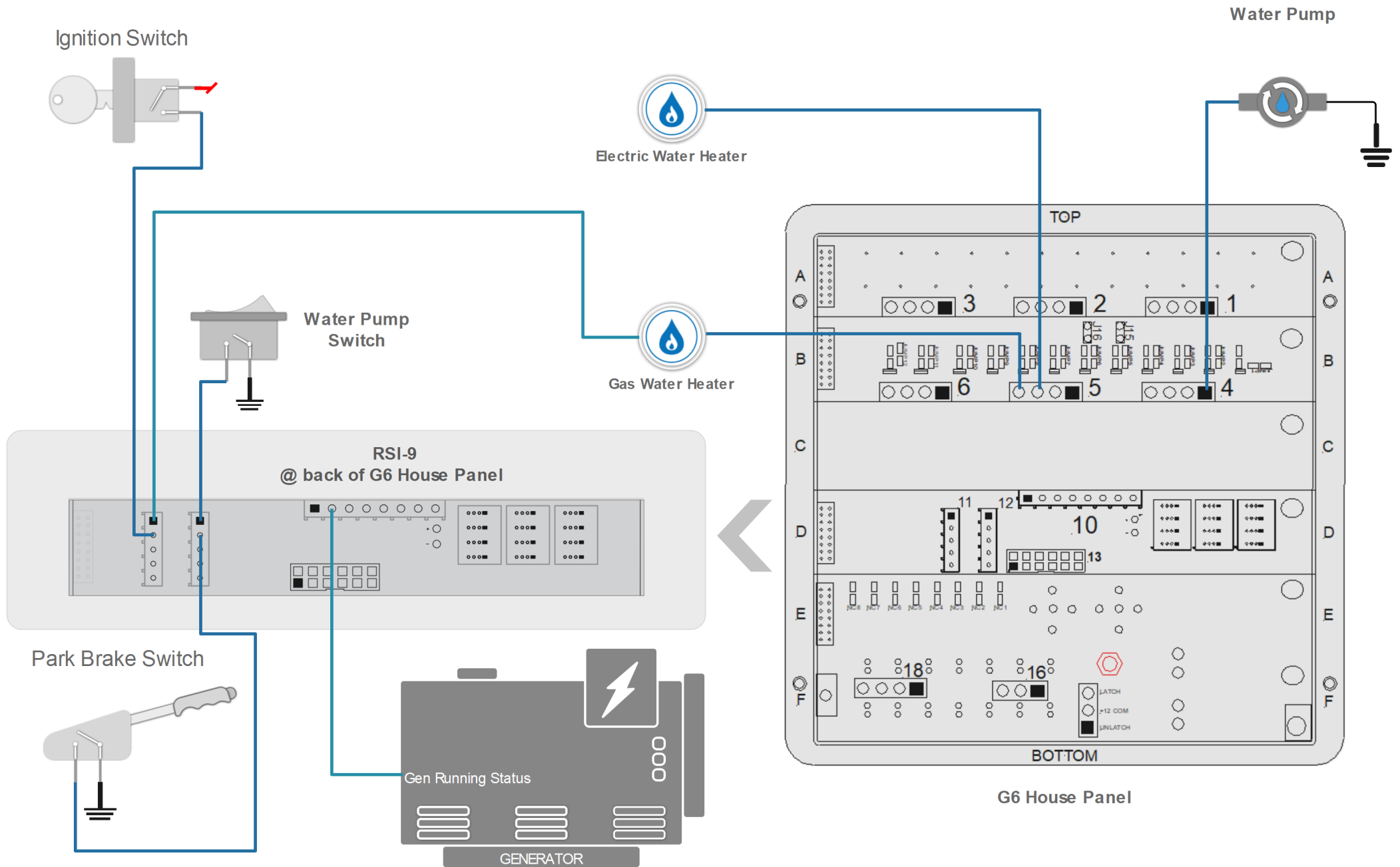

# 2021 Tiffin Wayfarer

## Network Connectors and Related Parts

(Components not to scale)

G3 Terminator Tap  
Tiffin P/N: 5051935

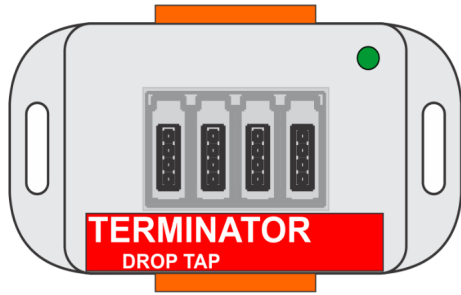

G3 Common Tap  
Tiffin P/N: 5027834

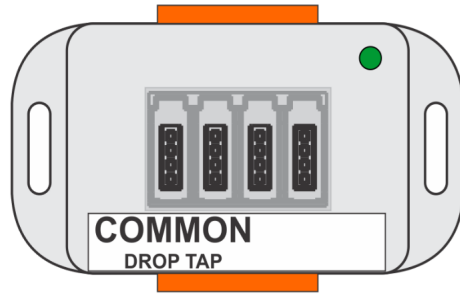

G4 Common Drop Tap  
Tiffin P/N: 5016592



Mini-Clamp Plug  
Tiffin P/N: 5066157



G4 Terminator Drop Tap  
Tiffin P/N: 5051936



Mini-Clamp Socket  
Tiffin P/N: 5066158



4 Pos Wago Connector  
Tiffin P/N: 5015508

